

FEATURES & SPECIFICATIONS

INTENDED USE — Available in several color temperatures, lumen packages and lengths. Ideal for use in commercial, retail, office, warehouse and display applications. **Certain airborne contaminants can diminish integrity of acrylic and/or polycarbonate.** [Click here for Acrylic-Polycarbonate Compatibility table for suitable uses.](#)

Certain airborne contaminants may adversely affect the functioning of LEDs and other electronic components, depending on various factors such as concentrations of the contaminants, ventilation, and temperature at the end-user location. [Click here for a list of substances that may not be suitable for interaction with LEDs and other electronic components.](#)

CONSTRUCTION — Compact-design channel and cover are formed from code compliant, 22 gauge cold-rolled steel.

SENSOR SWITCH JUST ONE TOUCH TECHNOLOGY — Single room control wireless technology available for easy install and commissioning to aid in code compliance. The JOT option enables the fixture with Just One Touch pairing capability. The JOTVIX15 option features a luminaire-embedded occupancy and ambient light sensor allows the luminaire to power off when the space is unoccupied or when enough ambient light is entering the space.

SENSOR SWITCH VISIBLE LIGHT PROGRAMMING TECHNOLOGY — Standalone sensor programming via VLP mobile app and smart device's camera flash from up to 8ft away.

FINISH — High-gloss, baked white enamel (standard).

OPTICS — LEDs provide 80+ color rendering index (CRI) at 3500K, 4000K and 5000K. Diffuse acrylic lens with ultra-sonically welded end caps provides smooth, linear illumination.

ELECTRICAL — Luminaire Surge Protection Level: Designed to withstand up to 2.5kV/0.75kA per ANSI C82.77-5-2015. For applications requiring higher level of protection additional surge protection must be provided.

Driver is standard 0-10V dimming class 2.

Optional internal pluggable wiring harness for reduced labor cost in row mounting applications. (See PLR_ ordering information on page 5.)

INSTALLATION — Fixture may be surface mounted to a ceiling or horizontal and vertical wall or suspension mounted with appropriate mounting options (see accessories). Easy to install row aligner bracket included for continuous row mounting.

LISTINGS — CSA certified to US and Canadian safety standards and listed suitable for damp locations. Minimum starting temperature of -22°F (-30°C). Maximum ambient operating temperature of 104°F (40°C) for 4ft models and 95°F (35°C) for 2ft & 8ft models. See notes for controls temperature restrictions.

DesignLights Consortium® (DLC) Premium qualified product and DLC qualified product. Not all versions of this product may be DLC Premium qualified or DLC qualified. Please check the DLC Qualified Products List at www.designlights.org/QPL to confirm which versions are qualified.

Suitable for use within closet spaces when installed per NEC 410.16 spacing requirements.

GOVERNMENT PROCUREMENT — BAA – Product with the BAA option qualifies as a domestic end product under the Buy American Act as implemented in the FAR and DFARS. Product with the BAA option also qualifies as manufactured in the United States under DOT Buy America regulations.

BABA – Build America Buy America: Product with the BAA option also qualifies as produced in the United States under the definitions of the Build America, Buy America Act.

Please refer to www.acuitybrands.com/buy-american for additional information.

WARRANTY — 5-year limited warranty. This is the only warranty provided and no other statements in this specification sheet create any warranty of any kind. All other express and implied warranties are disclaimed. Complete warranty terms located at: www.acuitybrands.com/support/warranty/terms-and-conditions

Note: Actual performance may differ as a result of end-user environment and application. All values are design or typical values, measured under laboratory conditions at 25 °C. Specifications subject to change without notice.

Catalog Number
Notes
Type

LED Strip Light

CSS



A+ Capable Luminaire

This item is an A+ capable luminaire, which has been designed and tested to provide consistent color appearance and out-of-the-box control compatibility with simple commissioning.

- All configurations of this luminaire meet the Acuity Brands' specification for chromatic consistency
- This luminaire is part of an A+ Certified solution for nLight® or XPoint™ Wireless control networks marked by a **shaded background***

To learn more about A+, visit www.acuitybrands.com/aplus.

*See ordering tree for details

CSS LED Strip Light

CS Looking for Contractor Select readily available configurations? Click here to visit Contractor Select™ spec sheet or go to www.contractorselect.com

ORDERING INFORMATION Lead times will vary depending on options selected. Consult with your sales representative. **Example:** CSS L96 ALO4 MVOLT SWW3 80CRI

Series	Nominal Length	Lumen Output	Voltage	Color temperature	Color rendering index
CSS Contractor Single Strip LED	L24 ‡ 22"	2000LM 2000 Lumens ALO15 Switchable lumens, 1500LM / 2000LM / 2500LM ‡	MVOLT 120-277V UVOLT 120-347V ‡	35K 3500K 40K 4000K 50K 5000K SWW3 Switchable white, 35K / 40K / 50K ‡	80CRI 80 CRI
	L48 48"	4000LM 4000 Lumens ALO3 Switchable lumens, 3000LM / 4000LM / 5000LM ‡			
	L96 96"	8000LM 8000 Lumens ALO4 Switchable lumens, 6000LM / 8000LM / 10000LM ‡			

Options	
Emergency Battery: ‡ IE7WCP Emergency battery pack, 7W, CA Title 20 Noncompliant IE10WCPHE Emergency battery pack, 10W, Certified in CA Title 20 MAEDBS	VLP Enabled Controls: ‡ VTX15FADC Vertex sensor with Visible Light Programming; On/Off Occupancy with Auto Dimming Photocell (default) VTX15FANL Vertex sensor with Visible Light Programming; High/Low/(Off) Occupancy Dimming with Auto Dimming Photocell (default)
Plug-in Wiring: ‡ PLR__ Plug-in wiring, see page 5 for ordering information PLR1LVG Plug-in wiring, low voltage dimming	Individual Controls: SFR7CSS120/277 120/277V Factory installed On/Off motion sensor, 360° small motion ‡ SFR7CSS347 347V factory installed On/Off motion sensor, 360° small motion ‡
JOT Enabled Wireless Controls: ‡ JOT Wireless room control with "Just One Touch" pairing JOTVTX15 Wireless occupancy sensor with "Just One Touch" pairing	

NOTE: ‡ indicates option chosen has ordering restrictions. Please reference ordering restrictions chart.

Switchable White & Adjustable Lumen Output – BAA Compliant:
CSS L48 ALO3 MVOLT SWW3 80CRI BAA
CSS L96 ALO4 MVOLT SWW3 80CRI BAA
CSS L96 ALO4 MVOLT SWW3 80CRI SFR7CSS120/277 BAA
CSS L48 ALO3 MVOLT SWW3 80CRI IE7WCP BAA
CSS L48 ALO3 MVOLT SWW3 80CRI IE10WCPHE BAA
CSS L96 ALO4 MVOLT SWW3 80CRI IE10WCPHE BAA
CSS L48 ALO3 MVOLT SWW3 80CRI IE10WCPHE SFR7CSS120/277 BAA
CSS L96 ALO4 MVOLT SWW3 80CRI IE10WCPHE SFR7CSS120/277 BAA

Accessories: Order as separate catalog number.	
HC36 M12	Hanger chain, 36" (1 pair)
ZACVH M100	Adjustable 10' aircraft cable with Y hanger (1 pair)
SQ_	Swivel stem hanger (specify length in 2" increments up to 48")
rPP20D	nLight® air dimming/switching module
SFR7CSS120/277	120/277V field installed On/Off motion sensor, 360° small motion ‡
SFR7CSS347	347V field installed On/Off motion sensor, 360° small motion ‡
Y J10	Y hanger in multiples of 10 (five pair)
WGCS	Wire Guard with Mounting hardware (one 4ft) ‡
MNLK JBOXCVR M12	Junction box cover and hardware, white

‡ Option Value Ordering Restrictions	
Option value	Restriction
L24	Not available with IE7WCP, IE10WCPHE, JOT, JOTVTX15, VTX15FADC, VTX15FANL, WG, SFR7CSS120/277, SFR7CSS347.
ALO15, ALO3, ALO4	Not available with 35K, 40K or 50K color temperatures.
SWW3	Not available with static lumen packages.
Emergency Battery	Not available with PLR
JOT Enabled Controls	Not available with ALO3, ALO4, UVOLT or SWW3. Minimum starting temp of 14°F (-10°C). Maximum operating temp of L48 at 95°F (35°C) & L96 at 86°F (30°C). Controls contained in endcap.
VLP Enabled Sensors	Not available with ALO15, ALO3, ALO4, UVOLT or SWW3. See page 5 for default programming and coverage pattern information. Sensors contained in endcap.
SFR Sensors	Can only be mounted at the end of continuous row mount applications. On/off function only. Minimum starting temp of 14°F (-10°C). Ensure correct sensor voltage selected for use with UVOLT fixtures based on application. See page 7 for coverage pattern.
SFR7CSS120/277	Sensor operates at ONLY 120V or 277V. Can NOT be used for 208V or 240V operation. Not available with L24.
SFR7CSS347	Sensor operates at 347V ONLY. Not available with MVOLT (120-277V). Not available with L24.
Wire Guard	Does not cover SFR controls. Not recommended for use with endcap integrated JOT or VLP enabled controls due to potential detection obstruction.
PLR_ & PLR1LVG	Not available with Emergency or Controls. L24 only available with PLR1LVG.
UVOLT	Not available with Emergency, JOT or VTX.
ILBHI CP10 HE SD A	High voltage emergency driver (347-480V). For use with UVOLT fixtures ONLY at 347V operation.

Emergency Battery Pack Options - Field Installable

Battery Model Number	Wattage	Runtime (Minutes)	Lumen Output* @ 120 Lumens/Watt	Other
ILB CP07 2H A	7W	120	840	Storm Shelter / 2 Hour Runtime
ILB CP10 A	10W	90	1200	
ILBLP CP10 HE SD A	10W	90	1200	Title 20, Self Diagnostic
ILB CP10 HE AELR A	10W	90	1200	Title 20; Enabled with Self Testing, Automated Reporting (STAR)
ILBHI CP10 HE SD A	10W	90	1200	347-480V operation, Self Diagnostic
ILBLP CP15 HE SD A	15W	90	1800	Title 20, Self Diagnostic
ILB CP20 HE A	20W	90	2400	Title 20
ILB CP20 HE SD A	20W	90	2400	Title 20, Self Diagnostic

All the above are UL Listed products that are certified for field install external/remote to the fixture.

*Minimum delivered lumen output to assist in product selection for increased fixture mounting height.



The CP10 delivered emergency illumination outperforms legacy 1400 lumen fluorescent emergency ballast.

Please contact us at techsupport@iotaengineering.com for any Emergency Battery related questions.

Enabled with STAR

Emergency Lighting with Self-Testing Automated Reporting (STAR), enables self-testing and automated reporting to aid in life safety code compliance. Build your solution and choose your preferred deployment from Mobile STAR, where test data is logged in each individual unit and broadcast to the **ClAIRity™+ app**, or Connected STAR, where test data is logged in the STAR Gateway by IOTA® and emailed directly. **Leave the ladders, disruptions and written records behind with emergency lighting solutions with STAR!**

Life Safety Code NFPA 101 testing and reporting requirements for emergency lighting include:

-  Testing for 30 seconds every 30 days
-  Testing for 90 minutes once a year
-  Record keeping and to report to the authority having local jurisdiction

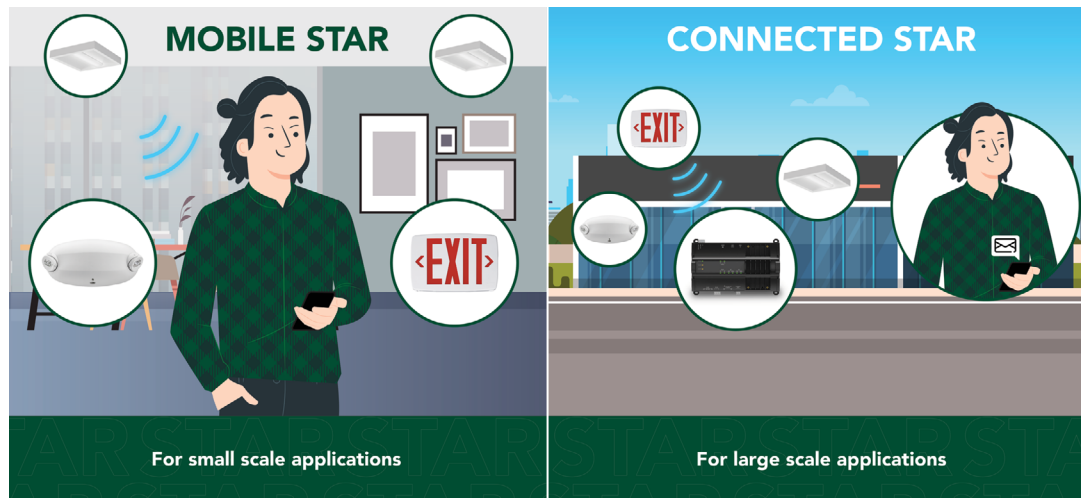

OPERATIONAL DATA

MVOLT

Nominal Length	Nominal Lumen Package	Color Temperature	Delivered Lumens	Wattage	Lumens/Watt	
L24	1500 LM					
	2000 LM	4000K	2144	15.3	140	
	2500 LM					
	AL015 (1500LM)	3500K	1889	13.2	143	
		4000K	1872	13.0	144	
		5000K	1842	13.3	139	
	AL015 (2000LM)	3500K	2256	16.5	137	
		4000K	2386	16.1	148	
		5000K	2357	16.5	143	
	AL015 (2500LM)	3500K	2600	19.7	132	
		4000K	2757	19.0	145	
		5000K	2634	19.6	135	
L48	3000 LM					
	4000 LM	4000K	4298	35.3	122	
	5000 LM					
	7000 LM					
	AL03 (3000LM)	3500K	3708	27.3	136	
		4000K	3931	26.3	150	
		5000K	3851	27.1	142	
	AL03 (4000LM)	3500K	4732	36.2	131	
		4000K	5076	34.8	146	
		5000K	4896	36.2	135	
	AL03 (5000LM)	3500K	5437	43.3	126	
		4000K	5884	41.5	142	
		5000K	5622	43.4	130	
	L96	6000 LM				
		8000 LM	4000K	8596	72.0	119
		10000 LM				
		14000 LM				
		AL04 (6000LM)	3500K	6272	46.2	136
4000K			6575	44.7	147	
5000K			6510	46.1	141	
AL04 (8000LM)		3500K	8173	64.1	128	
		4000K	8702	61.7	141	
		5000K	8450	64.5	131	
AL04 (10000LM)		3500K	11089	90.4	123	
		4000K	12046	86.5	139	
		5000K	11437	90.8	126	

UVOLT

Nominal Length	Nominal Lumen Package	Color Temperature	Delivered Lumens	Wattage	Lumens/Watt	
L24	1500 LM					
	2000 LM	4000K	2120	14.8	143	
	2500 LM					
	AL015 (1500LM)	3500K	1438	10.6	136	
		4000K	1464	10.3	142	
		5000K	1449	10.6	137	
	AL015 (2000LM)	3500K	1891	15.3	124	
		4000K	1961	14.9	131	
		5000K	1918	15.3	125	
	AL015 (2500LM)	3500K	2541	19.2	132	
		4000K	2654	18.7	142	
		5000K	2569	19.2	134	
L48	3000 LM					
	4000 LM	4000K	4803	37.9	127	
	5000 LM					
	7000 LM					
	AL03 (3000LM)	3500K	3501	25.7	136	
		4000K	3659	27.1	135	
		5000K	3540	27.1	131	
	AL03 (4000LM)	3500K	4435	34.5	129	
		4000K	4727	36.0	131	
		5000K	4521	36.0	126	
	AL03 (5000LM)	3500K	5665	46.0	123	
		4000K	6109	43.7	140	
		5000K	5710	45.7	125	
	L96	6000 LM				
		8000 LM	4000K	9606	75.8	127
		10000 LM				
		14000 LM				
		AL03 (6000LM)	3500K	6867	49.9	138
4000K			7199	49.9	144	
5000K			7128	49.9	143	
AL03 (8000LM)		3500K	8736	65.3	134	
		4000K	9301	65.3	142	
		5000K	9032	65.3	138	
AL03 (10000LM)		3500K	10989	90.9	121	
		4000K	11937	90.9	131	
		5000K	11333	90.9	125	

Note: All values are typical and are at 25C. Actual performance may vary and is dependent on operating environment.

PROJECTED LUMEN MAINTENANCE			
Lumen Maintenance Factor	0.91	0.81	0.75
Operating Hours	40,000	90,000	120,000

Note: Actual performance may vary based on ambient temperature of installed location.

DIMENSIONS

All dimensions are shown in inches unless otherwise noted.

Nominal Length	Length	Width	Height	Approximate weight	Fixtures per pallet	Pallet Dimensions
L24	22"	2.62	2.22	2.5 lbs	336	40 x 48
L48	48"	2.62	2.22	5 lbs	135	46 x 57
L96	96"	2.62	2.22	10 lbs	102	46 x 98.5

*Weights will vary slightly with added options.

2FT Assembly

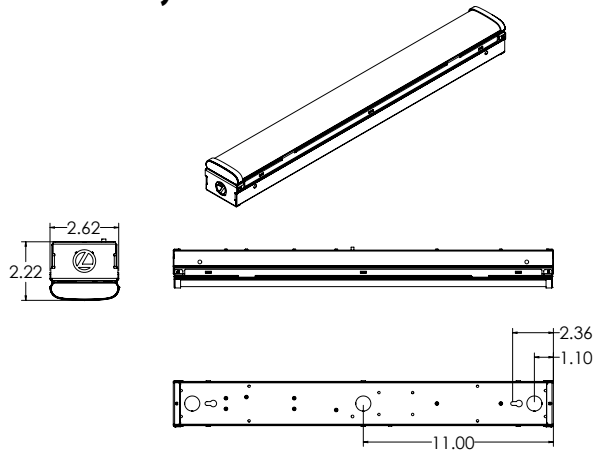

4FT Assembly

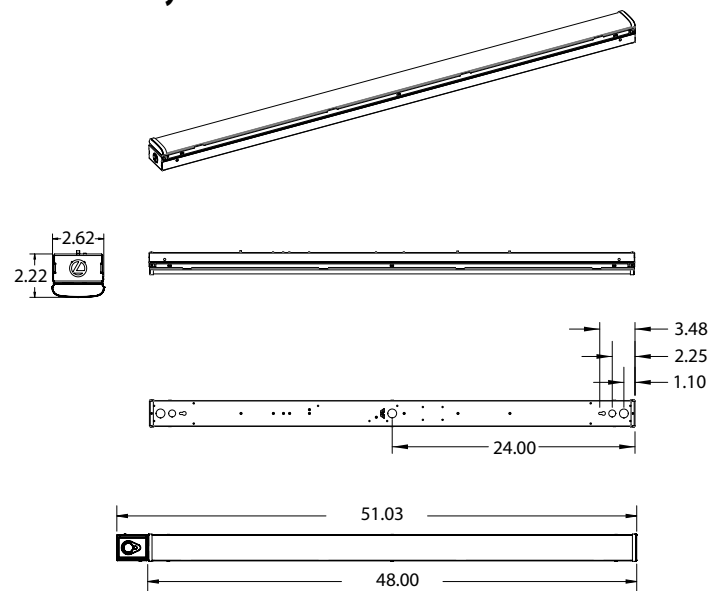

8FT Assembly

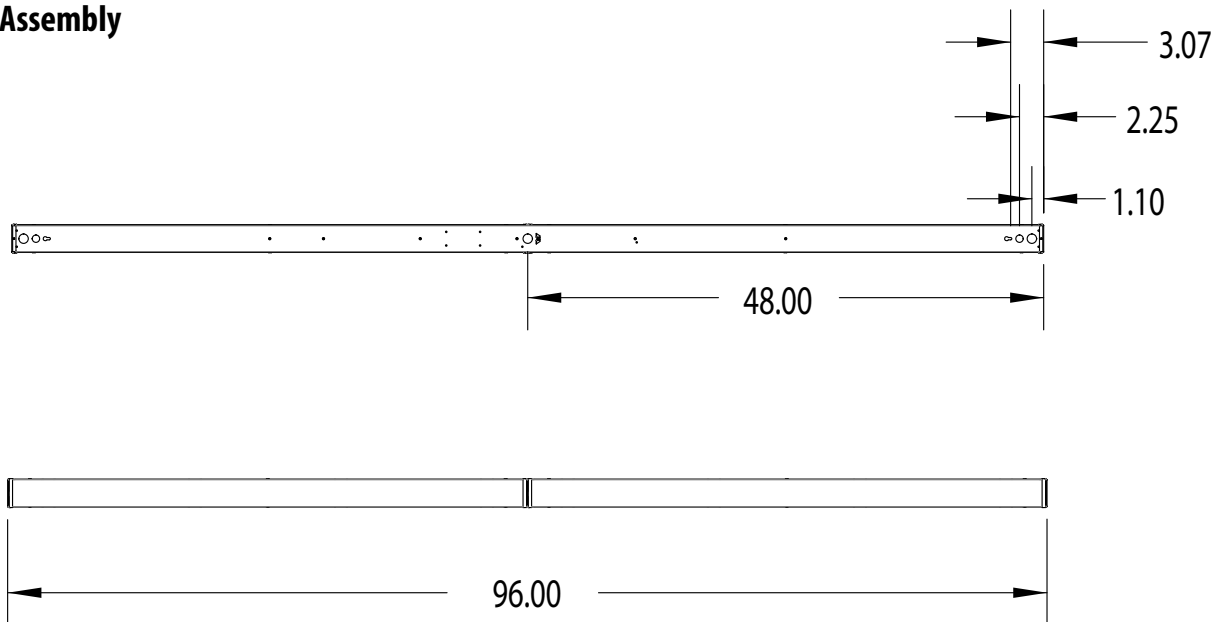

PLUG-IN WIRING OPTION

Advanced plug-in system with two-circuit capability. Available on industrial and strip products and a variety of architectural products mounted in continuous rows. PLR22 (2-circuit) and crossover harness switches hot circuit serving next fixture in row. Reduces fixture types on job for alternating circuit applications (see example below.)

Easy one-step installation, saves up to 35% on labor costs. Expanded switching flexibility helps save energy.

Rows can be 50% longer with two-circuit systems. Polarized, lock-together nylon connectors prevent miswiring in the field. #12 THHN conductor, rated 600V, 90°C. White neutral wire included. Grounding accomplished by fixture in-row connectors.

CSA certified systems available with up to 2 circuits. G ground required.

Not for use with dedicated emergency circuits.

Note: Specifications subject to change without notice.



PLR

Advanced 1 or 2-Circuit Plug-In

ORDERING INFORMATION Lead times will vary depending on options selected. Consult with your sales representative.

Series	Number of hot wires		Branch circuits	Dimming	Ground
PLR	(blank)	Not required for PLR22	<u>Circuits to which driver is connected</u>	LV Low-voltage dimming	G Ground (required)
PLR22	1	Black	(blank) Not required for PLR22		
	2	Black and red	A Black wire B Red wire		

Typical Applications

- Multiple-circuit and single-circuit for longer continuous rows
- Multiple-circuit with alternating fixtures on separate circuits and 2-circuit (PLR22)
- Multiple circuit with night-lights located along row as desired

JOT ENABLED WIRELESS CONTROLS

TYPICAL SMALL ROOM APPLICATION (UP TO 250 SQ. FT.)

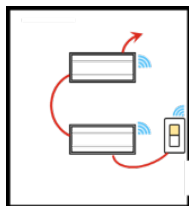

One Entryway
1x WSXA JOT
2x JOT Enabled Fixture

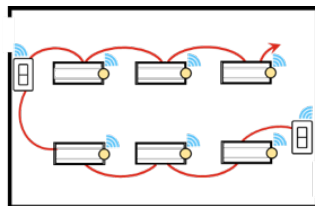

Two Entryways
2x SPODMRA JOT
6x JOT Enabled Fixture with Occupancy Sensor

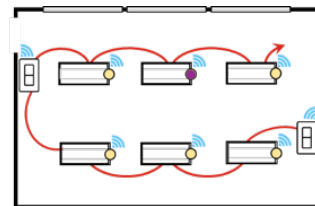

Two Entryways with Daylight Harvesting
2x SPODMRA JOT
1x JOT Enabled Fixture with Photocell and Occupancy Sensor
5x JOT Enabled Fixture with Occupancy Sensor



JOT

For use with
Sensor Switch
WSXA JOT
Dimming Wall
Switch Sensor

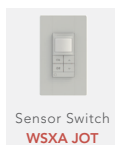

Sensor Switch
WSXA JOT



JOTVTX15

For use with
Sensor Switch
SPODMRA JOT
Dimming Wall
Switch

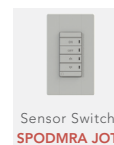

Sensor Switch
SPODMRA JOT

Option	Default Firmware					
	OCC Time Delay	Dim to Off Time Delay	Photocell Mode	Photocell Setpoint	Low Trim	High Trim
VTX15FADC or JOTVTX15	10 Min	N/A	On/Off & Auto Dimming	50FC	10%	100%
VTX15FANL		Stay At Dim (Never Off)				
SFR7CSS or SFR30CSS		N/A				

VTX & JOTVTX SENSOR COVERAGE PATTERNS

15F LARGE MOTION EXTENDED RANGE 360°

- Optimized full coverage from 8 ft - 15 ft (2.4 m - 4.5 m) mounting heights
- Reliable detection of large motion (e.g. pedestrian walking traffic)
- 1.3 x's mounting height equals approximate detection range



TOP VIEW

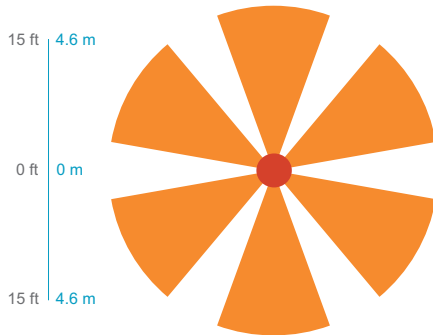

SIDE VIEW

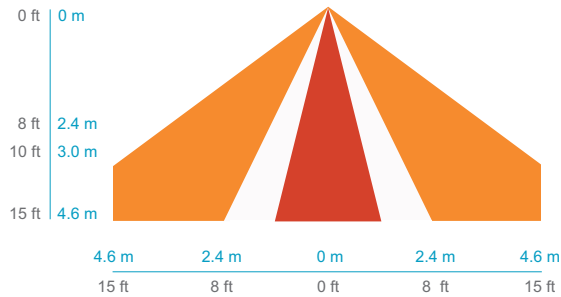

SFR SENSOR COVERAGE PATTERNS

SFR 7 MINI LOW BAY 360°

- Recommended for walking motion detection from mounting heights between 8 ft (2.44 m) and 20 ft (6.10 m)
- Initial detection of walking motion along sensor axes at distances of 2x the mounting height up to 15 ft (4.57 m) and 1.75x up to 20 ft (6.10 m).
- Provides 12 ft (3.66 m) radial detection of small motion when mounted at 9 ft (2.74 m)
- Initial detection will occur earlier when walking across sensor's field of view than when walking directly at sensor



9 FT MOUNTING

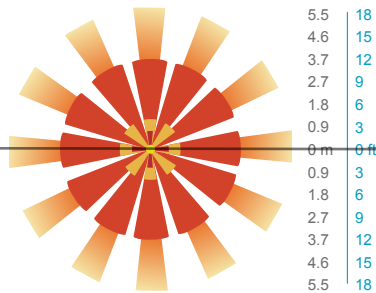

15 FT MOUNTING

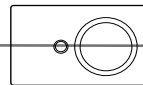
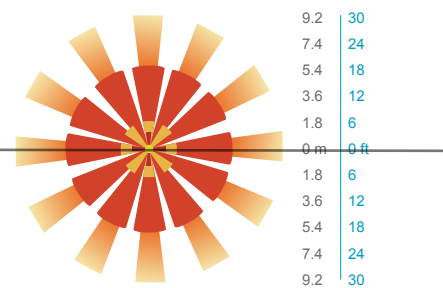

Note: Align sensor axes along aisleway for best detection results

MAXIMUM # OF FIXTURES PER SFR SENSOR

Nomenclature	Maximum # of Fixtures per SFR SENSOR
CSS L48 4000LM MVOLT	20
CSS L48 AL03 MVOLT	16
CSS L96 8000LM MVOLT	10
CSS L96 AL04 MVOLT	8

*PLR option recommended for continuous row mounting with SFR sensor. Input power for continuous row must come through end-of-row fixture with sensor. SFR sensor operates On/Off only.

PHOTOMETRICS

Please see www.lithonia.com.