

FEATURES & SPECIFICATIONS

INTENDED USE — Lithonia Linear is a suspended linear fixture designed for open, mixed, grid, or hard surface applications. The perfect blend of configurability and simplicity - Lithonia Linear is perfect for contractors, design builders, architects and specifiers for use in almost any application including open ceilings, retail, office, hospitality, education, healthcare, and transportation.

CONSTRUCTION — Lithonia Linear is built on an extruded aluminum chassis for the perfect blend of strength, weight, and thermal performance. The power modules/ end caps are made of injections molded plastic and lens is constructed of polycarbonate.

OPTICS — Lithonia Linear utilizes a frosted polycarbonate diffuser which provides an optimal 13% uplight to prevent a dark ceiling effect without reducing overall fixture efficiency.

CONTROLS — **Integrated Sensor (nLight® Wired Networking):** This sensor is nLight-enabled, meaning it has the ability to communicate over an nLight network. When wired, using CAT-5 cabling, with other nLight-enabled sensors, power packs, or WallPods, an nLight control zone is created. Once linked to a Gateway, directly or via a Bridge, the zone becomes capable of remote status monitoring and control via SensorView software.

Integrated Smart Sensor (nLight Air Wireless Platform): The RES7 sensor is nLight AIR enabled, meaning it has the ability to communicate over the wireless nLight control platform. It is available with an automatic dimming photocell, and either a digital PIR or a microphonics (PDT) dual technology occupancy sensor. It pairs to other luminaires and wall switches through our mobile app, CLAIRITY+, which allows for simple sensor adjustment

Integrated Wireless Sensor (single room control): Sensor Switch™ VPIR15 or VAPIR15 luminaire-embedded occupancy and ambient light sensor allows the luminaire to power off when the space is unoccupied or when enough ambient light is entering the space.

INSTALLATION — Lithonia Linear is designed to be extremely easy to install in multiple applications. Adjustable mounting points and aircraft cable make it easy to order, without knowing exact layouts and mounting points ahead of time. Just by determining if you have an open ceiling or T-grid style ceiling, you can order everything you need for a hassle-free installation. All power cords are factory installed and suspension hardware is included with each luminaire. We have taken the guesswork out of what you need for the installation.

LISTINGS — UL certified to US and Canadian safety standards. Damp location listed. IP5X Option. DesignLights Consortium® (DLC) qualified product. Not all versions of this product may be DLC qualified. Please check the DLC Qualified Products List at www.designlights.org/QPL to confirm which versions are qualified.

WARRANTY — 5-year limited warranty. This is the only warranty provided and no other statements in this specification sheet create any warranty of any kind. All other express and implied warranties are disclaimed. Complete warranty terms located at: www.acuitybrands.com/support/warranty/terms-and-conditions

Note: Actual performance may differ as a result of end-user environment and application. All values are design or typical values, measured under laboratory conditions at 25 °C. Specifications subject to change without notice.

MOUNTING HARDWARE — Mounting hardware included and optional replacement parts table on page 3.

Catalog Number
Notes
Type

Open Ceiling LED Suspended



Lithonia® Linear



EPD ZT DEC



EPD EZTR DEC



EPD EZCB DEC



ORDERING INFORMATION

Lead times will vary depending on options selected. Consult with your sales representative.

Example: LL8 6000LM 80CRI CPD MIN10 ZT MVOLT F1/120A DNA

Series	Lumens ‡	CRI	CCT	Power Drop (See images below on page 6)	Minimum Dimming Level	Dimming
LL4 4' LED Suspended	3000LM 3000 Lumens	80CRI	30K 3000K	CPD Center Power Drop ‡	MIN1 Dims to 1% ‡	ZT Generic 0-10V integrated driver ‡
	4000LM 4000 Lumens		35K 3500K	EPD End Power Drop ‡	MIN10 Dims to 10%	Remote driver box
	5000LM 5000 Lumens		40K 4000K			ZTR Generic 0-10V driver ‡
LL8 8' LED Suspended	6000LM 6000 lumens		50K 5000K			SLD Step level dimming ‡
	8000LM 8000 lumens					EZTR eldoLED 0-10V remote box
	10000LM 10000 lumens					EZCR eldoled controls remote box ‡
LL16 16' LED Suspended ‡	12000LM 12000 lumens					Driver backpack
	16000LM 16000 lumens					EZTB eldoLED 0-10V backpack ‡
	20000LM 20000 lumens					EZCB eldoled controls backpack ‡

Voltage	Emergency Option	Mounting Type/Overall Suspension ‡ (See images below on page 3)	Finish ‡
MVOLT MVOLT (120-277V) 347 347V ‡	(Blank) no emergency option IE10WCP 10W Emergency backup ‡ IE10WCPHE 10W Emergency backup w/standby mode (T20) ‡ IE7WCPHE 7W Emergency back w/standby mode (T20) ‡ GTD Generator Transfer Device ‡	F1/120A T-bar ceiling (universal mounting bracket) 120" (10ft) Adjustable Aircraft Cables, 18/5 SJT, Cord Included. Canopy included. F1/240A T-bar ceiling (universal mounting bracket) 240" (20ft) Adjustable Aircraft Cables, 18/5 SJT, Cord Included. Canopy included. F2/120A Hard Ceiling (horizontal J-box) 120" (10ft) Adjustable Aircraft Cables, 18/5 SJT, Cord Included. Canopy included. F2/240A Hard ceiling (horizontal J-box) 240" (20ft) Adjustable Aircraft Cables, 18/5 SJT, Cord Included. Canopy included. F3/120A Open Ceiling (closed loop) 120" (10ft) Adjustable Aircraft Cables, 18/5 SJT, Cord Included. Canopy not included. F3/240A Open Ceiling (closed loop) 240" (20ft) Adjustable Aircraft Cables, 18/5 SJT, Cord Included. Canopy not included.	WH Matte White, fixture finish and cord set DNA Natural Aluminum, fixture finish and white cord set MB Matte Black, fixture finish and cord set

NOTE: ‡ Indicates option chosen has ordering restrictions or note. Please reference ordering notes chart. Options are sorted alphanumerically.

LL LED Suspended

Controls	
Control Input (blank) No Control Input	Sensor (blank) No Sensor or Control Input function only, if selected.
NLTAIR2 nLight AIR Generation 2 (wireless) enabled ‡ NLTAIREM2 nLight AIR Generation 2 (wireless) enabled and UL924 Emergency Operation, via power interrupt detection ‡	(blank) No sensor, Control Input function only APIR Occ sensing with passive infrared - on/off functionality and auto dimming photocell APDT Occ sensor dual tech (passive infrared & microphonics) and auto dimming photocell APIREM Occ sensing with passive infrared - on/off functionality and auto dimming photocell and UL924 Emergency Operation, via power interrupt detection APDTEM Occ sensor dual tech (passive infrared & microphonics) and auto dimming photocell and UL924 Emergency Operation, via power interrupt detection.
NLIGHT nLight enabled NLIGHTER nLight enabled, for use with generator supply EM power NLIGHTLM nLight enabled with lumen management NLIGHTERLM nLight enabled with lumen management, for use with generator supply EM power	(blank) No sensor, Control Input function only PIR Occ sensing with passive infrared - on/off functionality PDT Occ sensor dual tech (passive infrared & microphonics) APIR Occ sensing with passive infrared - on/off functionality and auto dimming photocell APDT Occ sensor dual tech (passive infrared & microphonics) and auto dimming photocell VPIR15 Vertex low-profile on/off occupancy PIR occupancy sensor at 15ft mounting height
SSE Sensor Switch Embedded	APIR Occ sensing with passive infrared - on/off functionality and auto dimming photocell APDT Occ sensor dual tech (passive infrared & microphonics) and auto dimming photocell VPIR15 Vertex low-profile on/off occupancy PIR occupancy sensor at 15ft mounting height VAPIR15 Vertex low-profile on/off occupancy sensor with auto dimming photocell at 15ft mounting height
JOT JOT, "Just One Touch" (wireless) enabled	(blank) No sensor, Control Input function only VAPIR15 Vertex low-profile on/off occupancy sensor with auto dimming photocell at 15ft mounting height

End Cap Options (When ordering EPD. See page 6 with configuration examples. Aesthetic pieces only)	Options
(Blank) Center Power Drop DEC Decorative End Cap DEM Decorative End Module	IP5X Gasketing to meet IP5X rating ‡ NLG No Lithonia Logo

NOTE: ‡ Indicates option chosen has ordering restrictions or note. Please reference ordering notes chart. Options are sorted alphanumerically.

‡ Ordering Notes/ Restrictions	
Option value	Restriction
LL16	LL16 EPD ordered with controls must be EZCR. LL16 CPD ordered with NLTAIR, SSE/JOT can be ordered with EZCB and EZCR. If ordering NLIGHT, NLIGHTER, NLIGHTLM, NLIGHTERLM must be EZCR.
Lumens	Nominal lumen output.
CPD, EPD	CPD comes with (DEC) decorative end caps. CPD is not available in LL4. EPD ships with choice of decorative end caps (DEC) or decorative module (DEM). LL16 EPD ships with decorative module (DEM).
MIN1	Only available with nLight, nLight Air and EldoLED.
ZT	Not available with MIN1, Controls or EM, 347V.
ZTR	Generic driver available with with 347V, EM or GTD. Not available with MIN1 and controls
SLD	Only available with remote box driver. Not available with controls, 347V or MIN1.
EZCR	When ordering EZCR luminaire, two cords will run from the remote driver box to the power module on the fixture.
EZTB, EZCB	Not available with EM or 347V. EZTB not available with any Control options.
347	Must be remote driver box mounted. Not available with Emergency, GTD or ZT, EZTB, EZCB.
IE10WCP, IE10WCPHE, IE7WCPHE GTD	Not available with 347. Must be remote mounted – EZTR, EZCR, ZTR. Not available with ZT.
Mounting Type/ Overall Suspension	All mounting/suspension cable and hardware included. Refer to the Mounting/Suspension Hardware Included Key on page 3 for the number of suspension drops and power feed(s).
Finish	Metal components painted after fabrication.
NLTAIR2	Can be used as a normal power sensing device for nLight AIR devices and luminaires with EM emergency options. EZCR or EZCB must be chosen.
NLTAIREM2	See UL924 Sequence of Operation. Leave Sensor option group blank, not available with APIR, APDT, APIREM and APDTEM. EZCR or EZCB must be chosen.
NLIGHT, NLIGHTER, NLIGHTLM, NLIGHTLERM	Must be remote box mounted EZCR.
JOT	Only available with EZCR and EZCB.
IP5X	Gasketing for the driver enclosure to meet IP5X. Only available with ZT.

LL LED Suspended

WHAT'S IN THE BOX:



+ MOUNTING/ HARDWARE BAG

F1 – T-GRID ceiling mount	
LL4 EPD	1ZAC + 1ZACFP + 2 T GRID CLIPS
LL8 CPD	2ZAC + 1ZACFP + 3 T GRID CLIPS
LL8 EPD	1ZAC + 1ZACFP + 2 T GRID CLIPS
LL16 CPD	2ZAC + 1ZACFP + 3 T GRID CLIPS
LL16 EPD	2ZAC + 2ZACFP + 4 T GRID CLIPS

F2 – Hard ceiling mount	
LL4 EPD	1ZAC + 1ZACFP
LL8 CPD	2ZAC + 1ZACFP
LL8 EPD	1ZAC + 1ZACFP
LL16 CPD	2ZAC + 1ZACFP
LL16 EPD	2ZAC + 2ZACFP

F3 – Open ceiling mount	
LL4 EPD	2LLAC + 1PC
LL8 CPD	3LLAC + 1PC
LL8 EPD	2LLAC + 1PC
LL16 CPD	3LLAC + 1PC
LL16 EPD	4LLAC + 2PC

POWER CORD (PC)

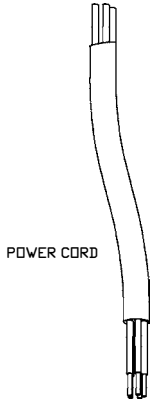

LLAC

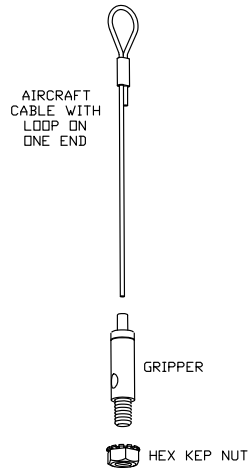

ZAC

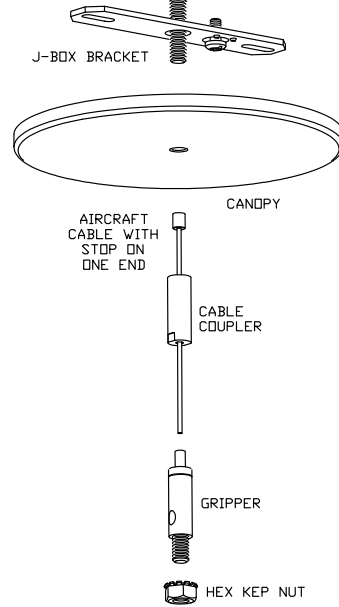

ZACFP

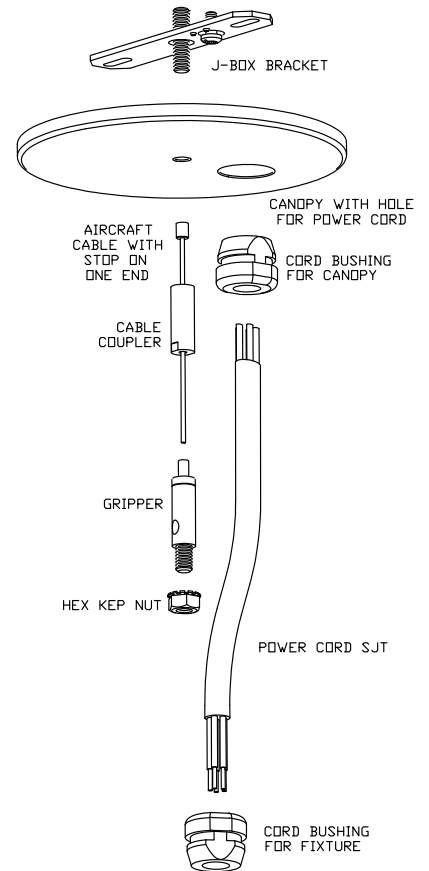

HARDWARE IMAGES

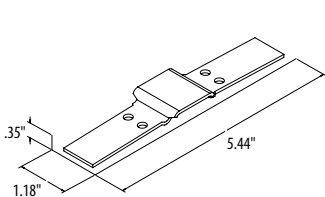

Joiner Bracket LLCR

Note: *Included with every fixture configurations

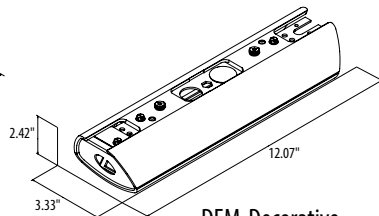

DEM-Decorative End Module

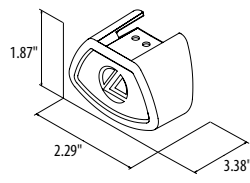

DEC-Decorative End Cap

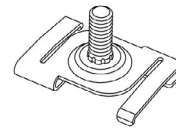

U0776 (Tgrid Clip)

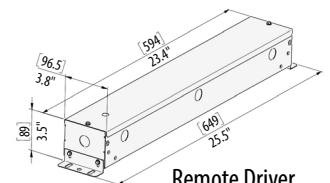

Remote Driver Box/Emergency Battery Box

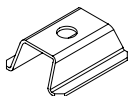

Sliding Mounting Hardware

Note: *Included with every fixture configurations



Screws for power Module Connection

Note: *Included with every fixture configurations

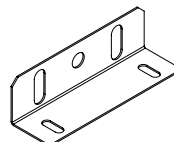

Remote Box Bracket

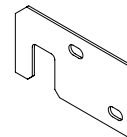

Remote Box Hanger Bracket

Intelligent Luminaire Technology Guide

		Choose nomenclature from these columns							
		Control Input	Sensor	Sensor		Notes		Previous Nomenclature	
Control / Sensor Configurations		SSE	+ APIR	=	MSD 7 ADCX	Individual fixture control only. PIR integral occupancy sensor with automatic dimming control photocell.		MSD7ADCX	
		SSE	+ APDT	=	MSD PDT 7 ADCX	Individual fixture control only. PDT integral occupancy sensor with automatic dimming control photocell.		MSDPDT7ADCX	
		SSE	+ VPIR15	=	VERTEX 15F EZ OCC VLP	Vertex low-profile on/off occupancy PIR occupancy sensor with VLP programming at 15ft mounting height.		VTX15FOCC	
		SSE	+ VAPIR15	=	VERTEX 15F EZ ADC VLP	Vertex low-profile on/off occupancy sensor with auto dimming photocell with VLP programming at 15ft mounting height.		VTX15FADC	
		JOT	+ (blank)	=	BTRM JOT BTA	Wireless room control with "Just One Touch" pairing.		JOT	
		JOT	+ VAPIR15	=	BTRM JOT BTA + VERTEX 15F EZ ADC VLP GSMT	Wireless room control with "Just One Touch" pairing.		JOTVTX15	
		NLIGHT	+ (blank)	=	nIO EZ PH	nLight enabled only. No onboard sensor.		NLIGHT	
		NLIGHT	+ PIR	=	nIO EZ PH + nES 7	nLight enabled with PIR integral occupancy sensor.		NLIGHT NES7	
		NLIGHT	+ PDT	=	nIO EZ PH + nES PDT 7	nLight enabled with dual technology occupancy control sensor.		NLIGHT NESPDT7	
		NLIGHT	+ APIR	=	nIO EZ PH + nES 7 ADCX	nLight enabled with PIR integral occupancy sensor with automatic dimming photocell.		NLIGHT NES7ADCX	
		NLIGHT	+ APDT	=	nIO EZ PH + nES PDT 7 ADCX	nLight enabled with dual technology occupancy controls sensor with automatic dimming photocell.		NLIGHT NESPDT7ADCX	
		NLIGHT	+ VPIR15	=	nIO EZ PH + VERTEX 16FT EZ OCC VLP	nLight enabled with Vertex low-profile on/off occupancy PIR occupancy sensor at 16ft mounting height.		NLIGHT NVTX16FOCC	
		NLIGHTER	+ (blank)	=	nIO EZ PH ER	Emergency nLight enabled only. No onboard sensor.		NLIGHT EMG	
		NLIGHTER	+ PIR	=	nIO EZ PH ER + nES 7	Emergency nLight enabled with PIR integral occupancy sensor.		NLIGHT EMG NESPDT7	
		NLIGHTER	+ PDT	=	nIO EZ PH ER + nES PDT 7	Emergency nLight enabled with dual technology occupancy control sensor.		NLIGHT EMG NES7ADC	
		NLIGHTER	+ APIR	=	nIO EZ PH ER + nES 7 ADCX	Emergency nLight enabled with PIR integral occupancy sensor with automatic dimming photocell.		NLIGHT EMG NES7ADCX	
		NLIGHTER	+ APDT	=	nIO EZ PH ER + nES PDT 7 ADCX	Emergency nLight enabled with dual technology occupancy controls sensor with automatic dimming photocell.		NLIGHT EMG NESPDT7ADCX	
		NLIGHTER	+ VPIR15	=	VERTEX 15F EZ OCC VLP	Emergency nLight enabled with Vertex low-profile on/off occupancy PIR occupancy sensor at 15ft mounting height.		NLIGHT NVTX15FOCC	
		NLIGHTLM	+ (blank)	=	nIO EZ PH N80	nLight enabled only with 80% constant lumen management. No onboard sensor.		NLIGHT CL80	
		NLIGHTLM	+ PIR	=	nIO EZ PH N80 + nES 7	nLight enabled with 80% constant lumen management with PIR integral occupancy sensor.		NLIGHT CL80 NES7	
		NLIGHTLM	+ PDT	=	nIO EZ PH N80 + nES PDT 7	nLight enabled with 80% constant lumen management with dual technology occupancy control sensor.		NLIGHT CL80 NESPDT7	
		NLIGHTLM	+ APIR	=	nIO EZ PH N80 + nES 7 ADCX	nLight enabled with 80% constant lumen management with PIR integral occupancy sensor with automatic dimming photocell.		NLIGHT CL80 NES7ADCX	
		NLIGHTLM	+ APDT	=	nIO EZ PH N80 + nES PDT 7 ADCX	nLight enabled with 80% constant lumen management with dual technology occupancy controls sensor with automatic dimming photocell.		NLIGHT CL80 NESPDT7ADCX	
		NLIGHTLM	+ VPIR15	=	nIO EZ PH N80 + VERTEX 8F EZ OCC VLP	nLight enabled with 80% constant lumen management with Vertex low-profile on/off occupancy PIR occupancy sensor at 16ft mounting height		NLIGHT CL80 NVTX16FOCC	
		NLIGHTLMER	+ (blank)	=	nIO EZ PH ER N80	Emergency nLight enabled only with 80% constant lumen management. No onboard sensor.		NLIGHT EMG CL80	
		NLIGHTLMER	+ PIR	=	nIO EZ PH ER N80 + nES 7	Emergency nLight enabled with 80% constant lumen management with PIR integral occupancy sensor.		NLIGHT EMG CL80 NES7	
		NLIGHTLMER	+ PDT	=	nIO EZ PH ER N80 + nES PDT 7	Emergency nLight enabled with 80% constant lumen management with dual technology occupancy control sensor.		NLIGHT EMG CL80 NESPDT7	
		NLIGHTLMER	+ APIR	=	nIO EZ PH ER N80 + nES 7 ADCX	Emergency nLight enabled with 80% constant lumen management with PIR integral occupancy sensor with automatic dimming photocell.		NLIGHT EMG CL80 NES7ADCX	
		NLIGHTLMER	+ APDT	=	nIO EZ PH ER N80 + nES PDT 7 ADCX	Emergency nLight enabled with 80% constant lumen management with dual technology occupancy controls sensor with automatic dimming photocell.		NLIGHT EMG CL80 NESPDT7ADCX	
		NLIGHTLMER	+ VPIR15	=	VERTEX 15F EZ OCC VLP	Emergency nLight enabled with 80% constant lumen management. Vertex low-profile on/off occupancy PIR occupancy sensor at 15ft mounting height.		NLIGHT EMG CL80 NVTX15FOCC	
		NLTAIR2	+ (blank)	=	RIO EZ PH 90D G2	nLight AIR Generation 2 enabled.		NLTAIR2 RIO	
		NLTAIR2	+ (blank)	=	RIO EZ PH ER 90D G2	nLight AIR Generation 2 enabled		NLTAIR2 RIOEM	
		NLTAIR2	+ APIR	=	RES7 G2	nLight AIR Generation 2 enabled.		NLTAIR2 RES7	
		NLTAIR2	+ APDT	=	RES7 PDT 180D G2	nLight AIR Generation 2 enabled.		NLTAIR2 RES7PDT	
		NLTAIR2	+ APIREM	=	RES7 EM 180D G2	nLight AIR Generation 2 enabled.		NLTAIR2 RES7EM	
		NLTAIR2	+ APDTEM	=	RES7 PDT EM 180D G2	nLight AIR Generation 2 enabled.		NLTAIR2 RES7PDTEM	

LL LED Suspended

OPTIONAL REPLACEMENT PARTS			
	CI Code	Model	Description
SUSPENSION KIT	*265WLF	LLAC120	120" cable gripper w/nut - NO Canopy
	*265WLG	LLAC240	240" cable gripper w/nut - NO Canopy
	*267MEP	LLCNPY WHT	White, 5" Canopy with 15/32" and 1/2" diameter holes
	*267MF2	LLCNPY BLK	Black, 5" Canopy with 15/32" and 1/2" diameter holes
	*211C82	ZAC120	120" cable gripper w/nut - INCL 5" MATTE WHITE CANOPY & BRACKET
	*250E2S	ZAC120 MB	120" cable gripper w/nut - INCL 5" MATTE BLACK CANOPY & BRACKET
	*217YRX	ZAC240	240" cable gripper w/nut - INCL 5" MATTE WHITE CANOPY & BRACKET
	*2512MC	ZAC240 MB	240" cable gripper w/nut - INCL 5" MATTE BLACK CANOPY & BRACKET
	*233RV9	ZACFPD120	5-conductor power feed & 120" cable gripper w/nut - INCL 5" MATTE WHITE CANOPY & BRACKET
	*250E7S	ZACFPD120 MB	5-conductor power feed & 120" cable gripper w/nut - INCL 5" MATTE BLACK CANOPY & BRACKET
	*233RVA	ZACFPD240	5-conductor power feed & 240" cable gripper w/nut - INCL 5" WHITE CANOPY & BRACKET
	*2512MJ	ZACFPD240 MB	5-conductor power feed & 240" cable gripper w/nut - INCL 5" MATTE BLACK CANOPY & BRACKET
	DEM- DECORATIVE END MODULE	*266EU4	LLCR WH DEM
*266EUK		LLCR MB DEM	Decorative end module, Matte Black
*266EUG		LLCR DNA DEM	Decorative end module, Natural Aluminum
DEC- DECORATIVE END CAP	*286VVV	LLCR WH DEC	Decorative end cap, Matte White
	*286VVX	LLCR DNA DEC	Decorative end cap, Natural Aluminum
	*286VVY	LLCR MB DEC	Decorative end cap, Matte Black
MISCELLANEOUS	*27253J	RK3LLCR	Joiner, Galvanized Steel (comes std w/fixture)
	*212NF3	U0776	Clip used to convert aircraft mounting from JBOX to T-Grid

DIMENSIONS:

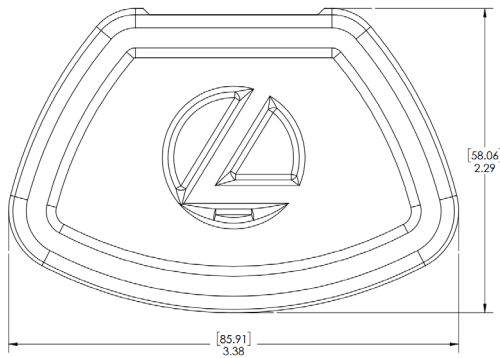

PERFORMANCE DATA

Nomenclature	Lumens	Wattage	LPW
LL4 3000LM 80CRI 40K MVOLT	3000	26	117
LL4 4000LM 80CRI 40K MVOLT	4045	33	123
LL4 5000LM 80CRI 40K MVOLT	4955	41	120
LL8 6000LM 80CRI 40K MVOLT	6111	50	121
LL8 8000LM 80CRI 40K MVOLT	8327	66	127
LL8 10000LM 80CRI 40K MVOLT	9786	79	124
LL16 12000LM 80CRI 40K MVOLT	12223	101	121
LL16 16000LM 80CRI 40K MVOLT	16655	131	127
LL16 20000LM 80CRI 40K MVOLT	19572	158	124

For 30K - Factor in 5% lumen reduction
 For 35K - Factor in 3% lumen reduction
 For 50K - Factor in 2% lumen increase
 For 347V - Factor in 12% wattage increase
 Refer to LL4 data upload

Projected LED Life	L90	L80	L70
Hours	44K	92K	150K

Values are projections based on TM-21 and at 25C Ambient.

PALLET DIMENSIONS

Length/configuration	Fixtures per pallet	Pallet Dims (L X W)
4ft	84	50X51
8ft CPD	42	51X51
8ft EPD	56	50X102
16ft CPD, EPD	56	50X102

FIXTURE WEIGHTS

Length	Weight
4ft	6lbs
8ft	8lbs
16ft	12lbs

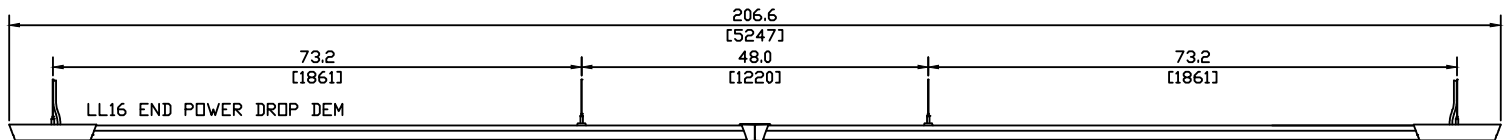
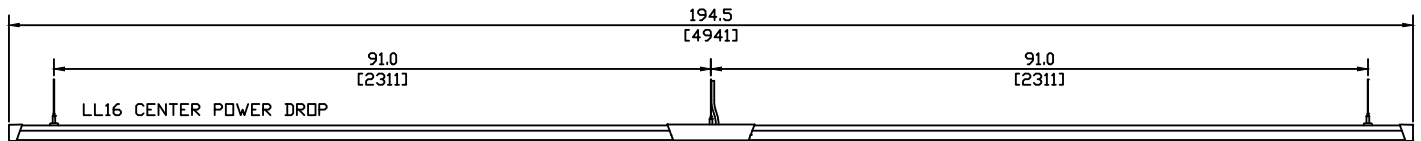
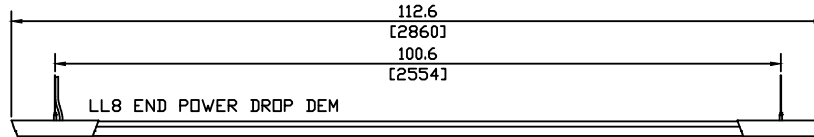
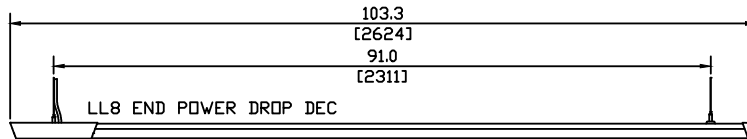
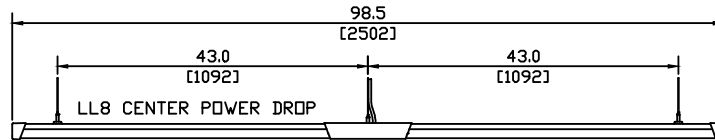
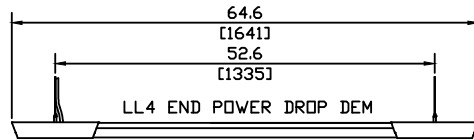
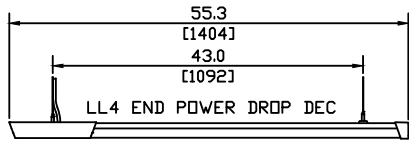

CONFIGURATIONS:

