

HSL11

Static White and Static Color Step Light 11

HIGHLIGHTS

- Integral Driver
- Short, Medium, and Long throw distributions
- Standard 0-10V dimming option
- Die-cast housing with solid aluminum, brass, or stainless steel faceplate
- Wet location listed
- Back Box provided by Hydrel or by others
- Suitable for concrete pour if BB option is chosen or Steel City back box is used

5
YEAR
warranty



DIMENSIONS

RECTANGLE

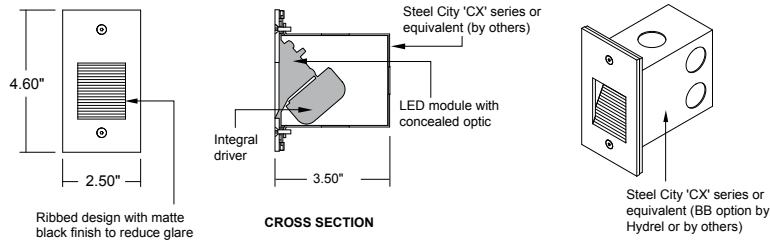

LUMEN PACKAGES

| Distribution | Delivered Lumens | Input Watts | Lumens/Watt |
|--------------|------------------|-------------|-------------|
| Short | 36 | 3 | 12 |
| Medium | 42 | 3 | 14 |
| Long | 54 | 3 | 18 |

Performance data based upon 30K LED 80CRI

ROUND

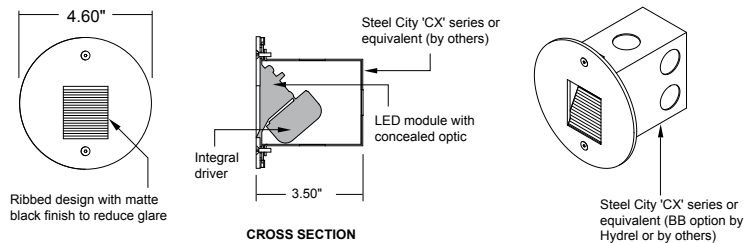

SQUARE

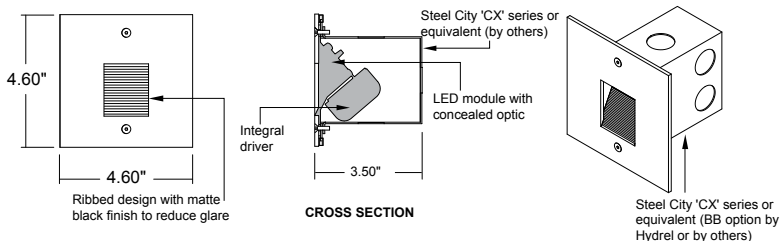

ORDERING INFORMATION

EXAMPLE: HSL11 SQ LED 27K MVOLT L MIN5 BRB

| Series* | Shape* | Source* | Color Temperature* | Voltage* | Distribution* |
|---------------------|--|------------|--|--|--|
| HSL11 Step Light 11 | RECT Rectangle RD Round SQ Square | LED | 27K 2700K 30K 3000K 35K 3500K 40K 4000K 50K 5000K | MVOLT Multi-Volt 120V thru 277V | L Long Throw M Medium Throw S Short Throw |
| | | | AMBLW Amber Limited Wavelength 590 nm BLU Blue RED Red RDO Red-Orange | | |

| Dimming Optional | OPTION | Finish* |
|----------------------------|---|---|
| MIN5 Dimming Driver | BB Back Box Note: Include BB if you need a back box, otherwise back box is by others. Note: Suitable for concrete pour if BB option is chosen or Steel City back box is used | BRB Brushed Brass BBP Brushed Brass Paint BRSS Brushed Stainless Steel LBPS Light Bronze Paint Smooth PBR Polished Brass PSS Polished Stainless Steel SGB Semi Gloss Black SGW Semi Gloss White CF Custom Finish RALTB Ral Paint Finishes Note: RALTB for pricing only, replace with applicable RAL call out when ready to order. See the RALBROCHURE for available options. It is recommended that Hydrel products only use textured paint. |

Note: * is a required field

PERFORMANCE DATA

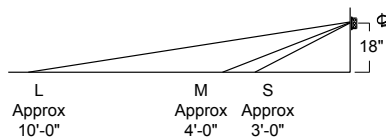

Typical Distribution Based on 30K

Grid in 1' increments

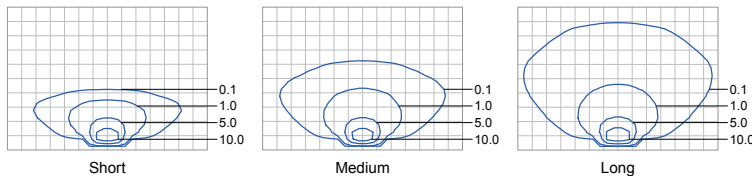

Lumen Multiplier Table for CCT

| CCT | Multiplier |
|-------|------------|
| 27K | 0.888 |
| 30K | 1.000 |
| 35K | 1.031 |
| 40K | 1.047 |
| 50K | 1.056 |
| AMBLW | 0.263 |
| RED | 0.318 |
| GREEN | 0.546 |
| BLUE | 0.283 |

BUG RATING CHART

| SERIES | CCT | Distribution | BUG Rating |
|--------|-----|---------------|------------|
| HSL11 | 30K | S Short Throw | B0U0G0 |

Note: For full report see IES file.

Expected Life: Static White LED: L70 @ 60,000 hours
 Static Color LED: L70 @ 60,000 hours

OPERATING TEMPERATURE: -40°C through 45°C

WIRING & DIMMING

POWER SUPPLY / DIMMING

Dimming drivers require a 0-10V fluorescent-type dimming control.

Read all instructions before installation. Do not make live connections!

NON-DIMMING INSTALLATIONS (For non-dimming, cap off the grey and purple wires separately)

Connect STEP WHITE wire to power NEUTRAL.

Connect STEP BLACK wire to power HOT.

Connect STEP GREEN wire to power GROUND.

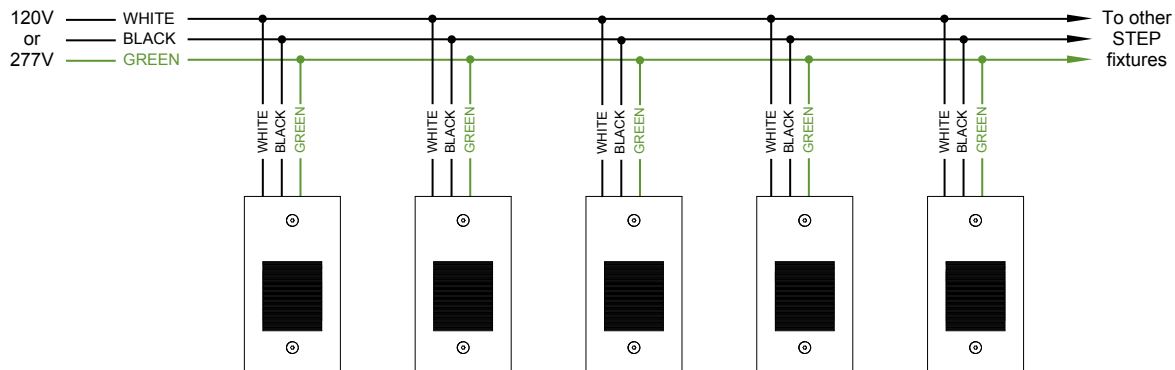

DIMMING INSTALLATIONS

The integral dimming driver is designed to the 0-10V IEC dimming specification 60929 and is compatible with common 0-10V dimmers and dimming systems.

Do NOT connect line voltage to dimming input wires.

Connect STEP WHITE wire to power NEUTRAL.

Connect STEP BLACK wire to power HOT.

Connect STEP VIOLET wire to POSITIVE INPUT of Dimming Control.

Connect STEP GREY or PINK wire to NEGATIVE INPUT of Dimming Control.

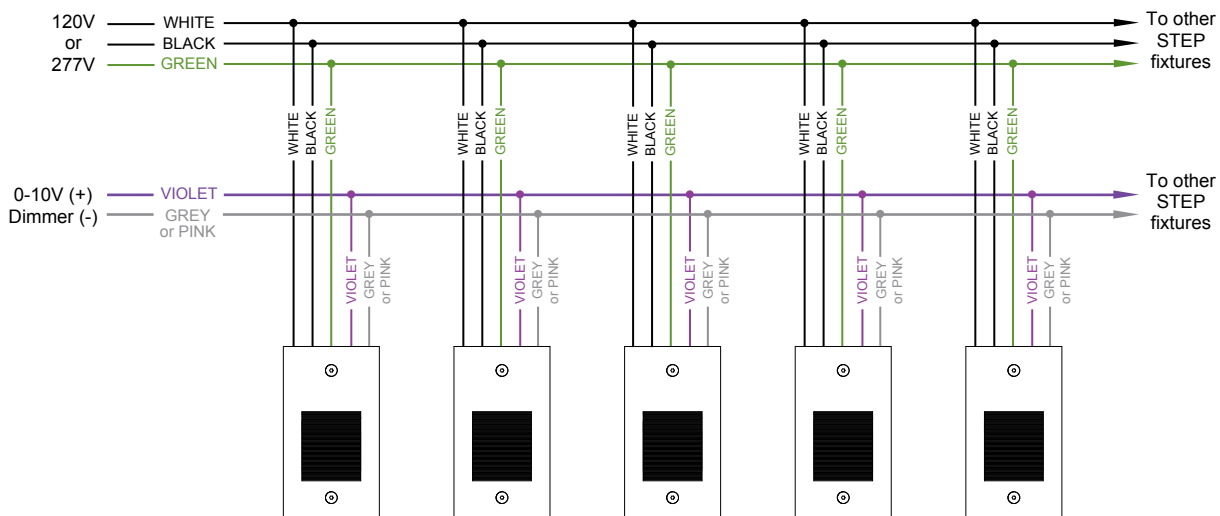

SPECIFICATIONS & FEATURES

Construction

Die-cast housing with solid aluminum, brass, or stainless steel faceplate. Two visible fasteners.

Source

Light source is a single powerful LED available in five static white color temperatures/80CRI & four colored LED choices. All within 3MacAdam ellipse

Optics

Concealed optic is available in three light distribution patterns. Short for narrow corridors, Medium for wide corridors, and Long for large area illumination.

Electrical

Integral electronic driver for 120 through 277v/50-60Hz input. Standard 0-10V dimming to 5%. THD: <20%. PFC: > 0.90. Complies to FCC CFR Title 47 Part 15, Class B at 120v and Class A at 277v EMI noise rating.

Mounting

Fixture designed to mount to a Steel City CX single gang deep junction box (BB option from Hydrel or by others) or equivalent.

Lens

Extruded clear acrylic optic lens concealed in reflector housing.

Circuiting

Single circuit

Environment

Wet location.

Government Procurement

BAA – Buy America(n) Act: Product qualifies as a domestic end product under the Buy American Act as implemented in the FAR and DFARS. Product also qualifies as manufactured in the United States under DOT Buy America regulations.

BABA – Build America Buy America: Product qualifies as produced in the United States under the definitions of the Build America, Buy America Act.

Please refer to www.acuitybrands.com/resources/buy-american for additional information.

Listing

c UL us (for the North American Market, US & Canada)

Finish

Recessed surfaces have a ribbed design with matte black finish to reduce glare. Faceplates are available in four metal finishes with protective clear coat or one of four polyester powder coat painted finishes.

Warranty

5-year limited warranty. This is the only warranty provided and no other statements in this specification sheet create any warranty of any kind. All other express and implied warranties are disclaimed. Complete warranty terms located at:

www.acuitybrands.com/support/warranty/terms-and-conditions

NOTE: Actual performance may differ as a result of end-user environment and application.

All values are design or typical values, measured under laboratory conditions at 25 °C.

Specifications subject to change without notice.