



# MARKCOVE



But Cove luminaire design and installation woes often lead to more time and money spent on the jobsite, forcing specifiers to avoid cove lighting or seek other solutions that unify a space without added design or installation risks.

The MARKCOVE integrated cove system combines aesthetics with a robust system design to deliver a consistent, installation-friendly experience.

With form complementary to function, MARKCOVE is a versatile integrated cove system with a robust construction and assembly.

Choose the architectural integrated cove solution that's right for you.



KNIFE EDGE MUD-IN



KNIFE EDGE DRYWALL



SQUARE EDGE MUD-IN

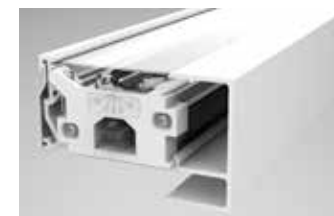

SQUARE EDGE DRYWALL

## CREATE LAYERS OF LIGHT

With MARKCOVE, create an accent layer across horizontal or vertical surfaces and simultaneously provide indirect ambient lighting to establish layers of light.

The luminaire features:

- 2, 3 and 4-foot lengths
- Two distributions: Asymmetric and Lambertian
- Precision optics for consistent aesthetic appearance
- Clear, wipe-down lens



Asymmetric and Lambertian Optics

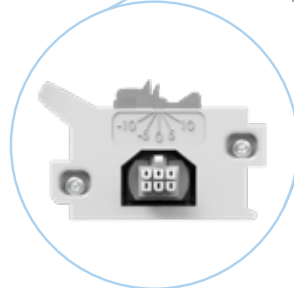
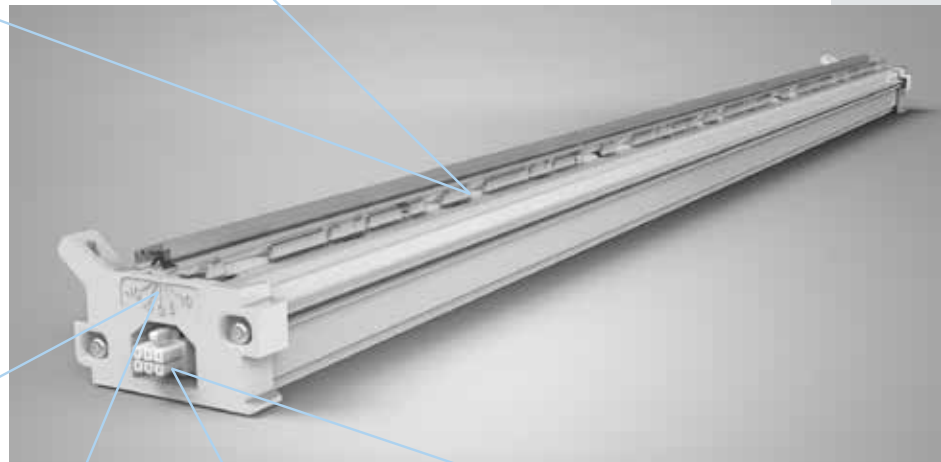

Adjustable optics

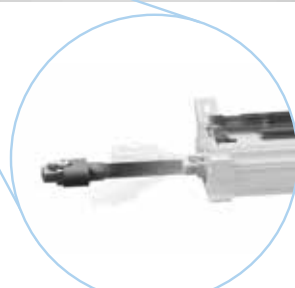

Adjustable fixture cable length 0-1.5

## EMPHASIZE ARCHITECTURAL DETAILS WITH ASSORTED ACCESSORIES



Feed Cables



Conduit Cable Box



Jumper Cable

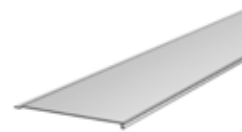

Frosted Lens

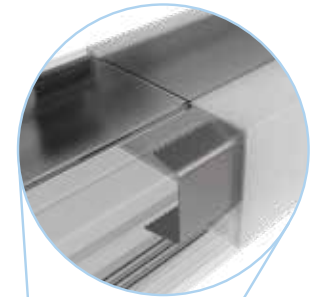

Tool-less Alignment and Light Leak Blocker

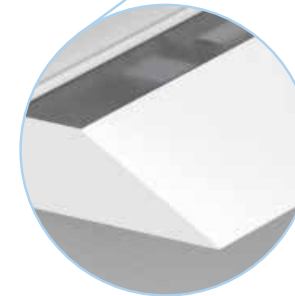
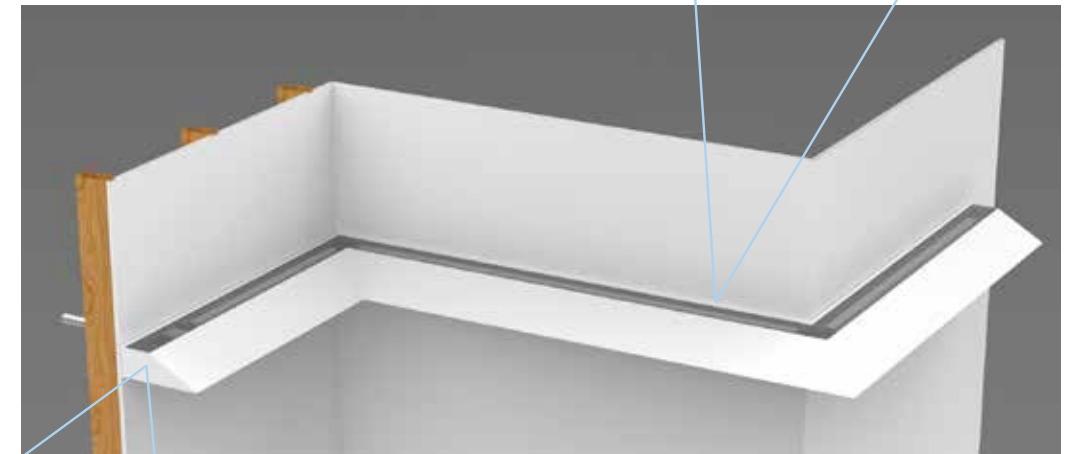

End of Run Endcaps For All Profiles

## EXPERIENCE SIMPLIFIED INSTALLATION

Using a robust engineering design, MARKCOVE seamlessly integrates into your architectural design with a simplified, safer installation compared to custom-crafted cove solutions. MARKCOVE increases efficiency by reducing installation time and minimizing return visits to the jobsite.

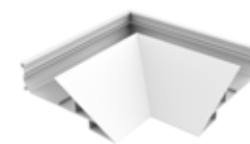

Inside Corners



Outside Corners



Mounting Clip

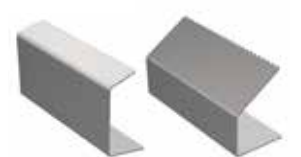

Light Leak Blocker and Alignment Bracket



#### TUNABLE WHITE

Tunable White enables occupants to adjust color temperatures to align with different activities, times of day and environments.



#### STATIC WHITE AND STATIC COLOR

Select from static white color temperatures or vibrant red, green, blue and amber static colors.



#### WARM DIMMING

Warm Dimming is reminiscent of evening light, dramatically impacting the ambiance of a space.



#### NLIGHT

Networked lighting controls reduces energy costs, aids in building code compliance, occupant comfort and much more. nLight® is a lighting controls solution that is easy to specify, install, and use that grows with the pace of your business today and tomorrow.



#### NLIGHT WIRED

Using only standard CAT-5e cables, an occupancy sensor, wall stations and digital LED luminaires, the nLight networked digital lighting system provides unmatched flexibility.



#### NLIGHT AIR

This simplified wireless lighting control solution for renovation projects is comprised of a smart sensor embedded in Acuity Brands® LED fixtures and wireless battery powered nLight AIR wall switches. The nLight AIR system allows you to confidently and quickly finish the job and move on to the next one with easy to install wireless controls – fewer devices, no wires.



**MARK** ARCHITECTURAL  
LIGHTING

Learn more at [www.MarkLighting.AcuityBrands.com/MARKCOVE](http://www.MarkLighting.AcuityBrands.com/MARKCOVE)

*The product images shown are for illustration purposes only and may not be an exact representation of the product.*

Join the conversation – follow us on social media.

