

TYPE:

PROJECT:

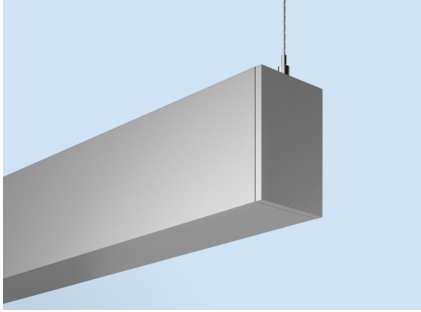

# SLOT 2

PENDANT INDIRECT  
TUNABLE WHITE

## HIGHLIGHTS

- 300 to 1500 lumens per foot Indirect
- 3 indirect distributors: Lambertian, Batwing or Asymmetric
- Optional Top Glow lens treatment
- Integrated control with nLight for system networking
- White, black or silver paint with satin finish
- Declare listed
- UGR is less than 10 for fixtures with 100% indirect only optics per CIE 117-1995 Discomfort Glare in Interior Lighting.



## FIXTURE PERFORMANCE

	Indirect			
Nominal Lumens/Foot				
Delivered Lumens/Foot				
Input Watts/Foot				
Lumens/Watt				

Based on a 4ft 35K fixture with standard lambertian distribution



## INDIRECT DISTRIBUTION

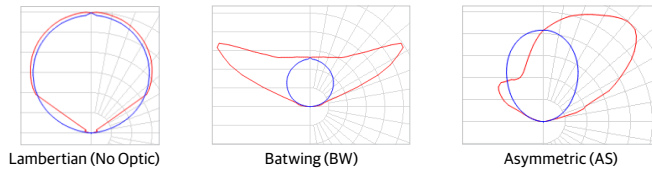

## DIMENSIONS

See page 5 for additional details.

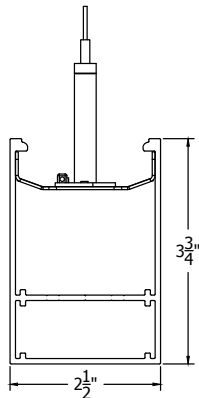

## DIFFUSERS/SHIELDING

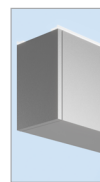

Top Glow (TGLD)

**ORDERING**

Example: S2PI LLP 32FT MSL8 I90CRI TUWH RHYP I120OLMF DARK FLL SCT MVOLT WHTT NLT F1/36A RDCY WHTCY WCRD

Series	Linear Plan	Total Run Length	Max Section Length	Direct Dynamic Feature	Direct Dynamic Range	Indirect Light Source Color Rendering	Indirect LED Light Output
<b>S2PI</b> Slot 2 Pendant Indirect (Formerly S2LI)	<b>LLP</b> Linear Longest Possible <b>LCB</b> Linear Center Balanced <b>LSL</b> Longest Same Length  For more information on linear plans, see page 4.	<b>_FT</b> Specify Continuous Run Length (in 1' increments, 2' minimum)  Unit length may affect available options. <b>For runs longer than 8FT: ALWAYS order the run by the TOTAL RUN LENGTH. Ordering the sections individually will not provide the correct joining hardware to allow connection in the field.</b>	<b>MSL3</b> 3FT Length <b>MSL4</b> 4FT Length <b>MSL6</b> 6FT Length <b>MSL7</b> 7FT Length <b>MSL8</b> 8FT Length	<b>TUWH</b> Tunable White	<b>RHYP</b> Rhythm Range (2700K-6500K)	<b>I80CRI</b> 80CRI <b>I90CRI</b> 90CRI	<b>I300LMF</b> 300 Lumens per FT <b>I400LMF</b> 400 Lumens per FT <b>I600LMF</b> 600 Lumens per FT <b>I800LMF</b> 800 Lumens per FT <b>I1000LMF</b> 1000 Lumens per FT <b>I1200LMF</b> 1200 Lumens per FT <b>I1400LMF</b> 1400 Lumens per FT <b>I1500LMF</b> 1500 Lumens per FT <b>_LMF</b> Specify Lumens between 300LMF - 1500LMF in 50LMF increments

Indirect Distribution	Switching	Minimum Dimming Level	Indirect Shielding	Voltage	Finish
<b>(blank)</b> Lambertian <b>BW</b> Batwing Distribution <b>AS</b> Asymmetrical Distribution  Indirect Distribution options are only available in whole foot increments. They are not available with E10WLCP or GTD.	<b>SCT</b> Single Circuit	<b>DARK</b> Constant Current, Dimming To 0.1%	<b>(blank)</b> No Indirect Shielding <b>TGLD<sup>1</sup></b> Top Glow Lens <b>DC</b> Dust Cover, Clear <b>DCF</b> Dust Cover, Frosted  1. TGLD is only available in whole foot increments. It's not available with E10WLCP.	<b>MVOLT</b> Multi-Volt, 120-277 <b>120</b> 120V <b>277</b> 277V	<b>WHTT</b> White (Satin) <b>BLKT</b> Black (Satin) <b>SLVT</b> Silver (Satin) <b>RALTB<sup>1</sup></b> <a href="#">RAL Paint Finish</a>  RALTB <sup>1</sup> is for pricing only. Replace with applicable RAL number & finish when placing order.

Secondary Power Options	Control Input	Mounting	Overall Suspension	Canopy Form	Canopy Color
<b>(blank)</b> Secondary Power Options <b>_E10WLCP<sup>1</sup></b> # of 10W Battery Packs, Constant Power, Self Diagnostics, T20 Compliant  <b>WEC</b> Emergency Circuit for Entire Run <b>_EC<sup>2</sup></b> # of Emergency Circuits <b>GTD<sup>2</sup></b> Generator Transfer Device (Remote mounted)  1. E10WLCP is not available in units under 7' 2. GTD is remote mounted. (See more information on page 9.) GTD is not available with MVOLT.	<b>NLT</b> nLight nTune Device  For additional ordering assistance consult "Intelligent Luminaire Technology Guide" on page 7	<b>F1/</b> T-Bar Ceiling with Universal Mounting Bracket <b>F1A/</b> T-Bar Ceiling with Universal Mounting Bracket & Integrated J-Box <b>F2/</b> Hard Ceiling	<b>36A</b> 36" Adjustable <b>72A</b> 72" Adjustable <b>144A</b> 144" Adjustable <b>240A</b> 240" Adjustable <b>300A</b> 300" Adjustable	<b>RDCY</b> Round Canopy <b>SQCY</b> Square Canopy	<b>BLKCY</b> Black Canopy <b>WHTCY</b> White Canopy <b>SLVCY</b> Silver Canopy

Cord Color	Options
<b>WCRD</b> White Cord <b>BCRD<sup>1</sup></b> Black Cord CAT5 cord, when included, will be white. 1. Black cord is not available with 300A.	<b>(blank)</b> No Options <b>MCS</b> Matching Support Canopy <b>PIF<sup>1</sup></b> Feed Cord Installed <b>BAA</b> Buy America(n) Act and/or Build America Buy America Qualified  1. Cord length will match overall suspension length specified.

**NOTE:** Unit length and lumen outputs may affect available options.

**LINEAR PLAN**

Mark Lighting offers the ability to provide a continuous run plan to suit your requirements by optionally offering three different methods of configuration.

**LLP- Linear Longest Possible**

In this configuration, the longest length available is optimized, resulting in the fewest segments and mounting locations. Caution should be used where balanced appearance is a concern. Example: 20 FT run would have 2, 8 FT segments and 1, 4 FT segment at the end of the run.



**LCB- Linear Center Balanced:**

This configuration incorporates the longest center segment(s) along with any additional lengths required to fill the run length, added to the run ends. Example: 16 FT run would have 2, 4 FT segments (one at each end) and 1, 8 FT segment in the center.

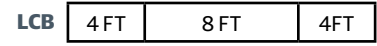

**LSL- Linear Same Length:**

In this configuration, each segment is the same length and is standardized based on the longest length available and is the only option provided. Because it is dependent on one segment length and there are mathematical limitations on what overall row lengths can be achieved. Example: 20 FT row would be achieved with 5, 4 FT long segments equaling 20 FT (nominal).

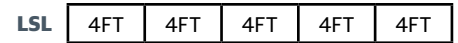

**Total Run Length**

This system is not modular. Runs longer than 8FT will be automatically configured with left, intermediate and right sections, based on how you specify the TOTAL RUN LENGTH and MAXIMUM SECTION LENGTH parameters in the ordering information. Always order the total run length, not the individual sections.

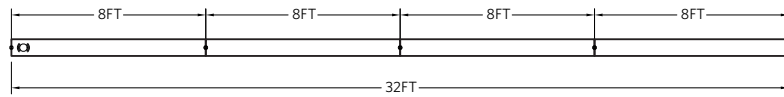

Example: This run must be ordered as 1pc "S2PI LLP 32FT MSL8..."

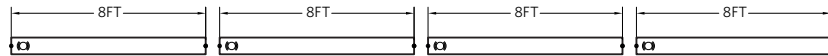

Example: If you order as 4pcs "S2PI LLP 8FT MSL8... you will receive these INDIVIDUAL sections that cannot be joined together

**Maximum Section Length**

The run will be broken out using as many sections at the chosen maximum section length as possible. Shorter sections will then complete the desired run length.

Examples:

S2PI LLP 21FT MSL5... = 5FT / 4FT / 4FT / 4FT / 4FT

S2PI LLP 21FT MSL6... = 6FT / 6FT / 5FT / 4FT

S2PI LLP 21FT MSL7... = 7FT / 7FT / 7FT

S2PI LLP 21FT MSL8... = 8FT / 8FT / 5FT

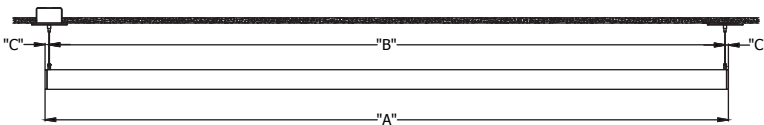

INDIVIDUAL FIXTURES				
ORDERED LENGTH	"A" O.A.L.	"B" O.C.	"C" FROM END	APPROX. WEIGHT
3FT	3'- 0 9/16"	2'- 11 13/16"	3/8"	2.4 LBS
4FT	4'- 0 9/16"	3'- 11 13/16"	3/8"	3.2 LBS
6FT	6'- 0 9/16"	5'- 11 13/16"	3/8"	4.8 LBS
7FT	7'- 0 9/16"	6'- 11 13/16"	3/8"	5.6 LBS
8FT	8'- 0 9/16"	7'- 11 13/16"	3/8"	6.4 LBS

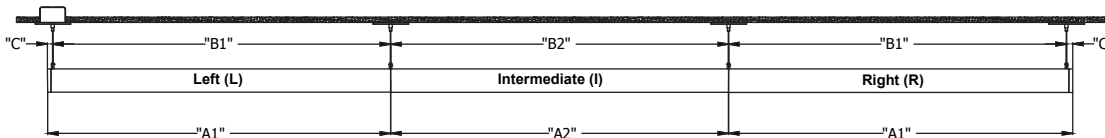

RUN LAYOUT						
ORDERED LENGTH	"A1" O.A.L.	"A2" O.A.L.	"B1" O.C.	"B2" O.C.	"C" FROM END	APPROX. WEIGHT
4FT	4'- 0 1/4"	4'- 0"	3'- 11 15/16"	4'- 0"	3/8"	3.2 LBS
6FT	6'- 0 1/4"	6'- 0"	5'- 11 15/16"	6'- 0"	3/8"	4.8 LBS
7FT	7'- 0 1/4"	7'- 0"	6'- 11 15/16"	7'- 0"	3/8"	5.6 LBS
8FT	8'- 0 1/4"	8'- 0"	7'- 11 15/16"	8'- 0"	3/8"	6.4 LBS

**SHIELDING, OPTICS & CONNECTORS**

**Indirect Shielding**

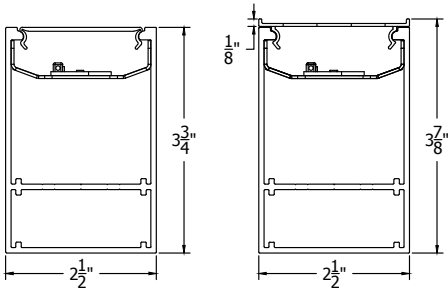

Dust Cover  
(DC, DCF)

Top Glow (TGLD)

**Indirect Optics**

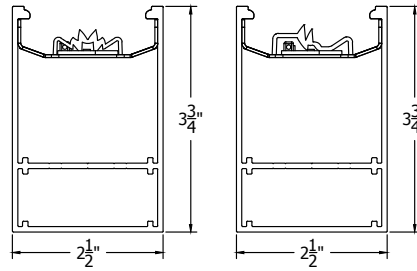

Batwing (BW)

Asymmetric (AS)

**MOST COMMON MOUNTING TYPES AND OPTIONS** Options available for this specific luminaire are checked in the boxes below.

**Mounting Type**

- F1/** For use with most T-Bar and screw slot grid ceilings. Designed for on-grid and off-grid applications. (J-box by others)
- F1A/** For use with most T-Bar grid ceilings. Designed for on-grid applications. Comes complete with J-box with built-in cutout to go over grid
- F2/** For use with recessed or surface mount horizontal J-box applications. (J-box by others)

**Mounting Options**

- MCS** MCS canopy supplies 5" canopy to match feed point canopy size. Matching canopy at support for aesthetics.
- PIF** Feed cord installed in fixture.

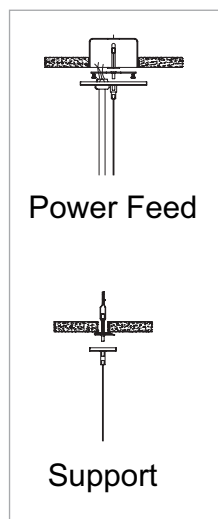

**Mounting with Feed (SPSWIFK)**

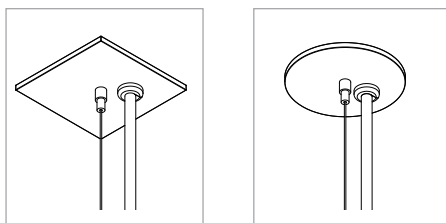

5" Square

5" Round

**Mounting with Dual Feed (SPSW2FK)**

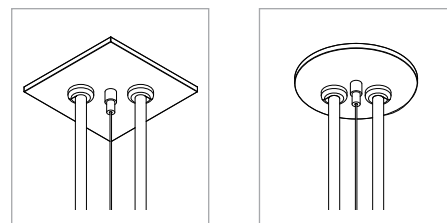

5" Square

5" Round

**Mounting Support (SPSWSK)**

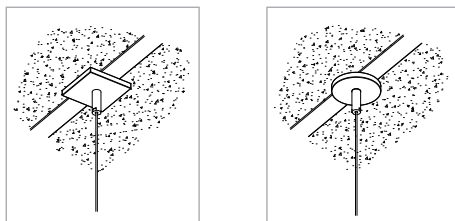

2" Square

2" Round

**MCS Option**

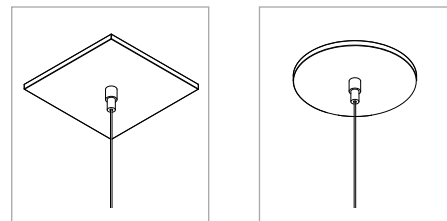

5" Square

5" Round

**INTELLIGENT LUMINAIRE TECHNOLOGY GUIDE**

Choose nomenclature from these columns				
Driver Configurations	Minimum Dimming Level	Control Input	Dimming Range	Notes
	DARK	NLT	100 to 0.1%	

UL924 Sequence of Operation
<p>The below information applies to all nLight AIR devices with an EM option.</p> <ul style="list-style-type: none"> <li>EM devices will remain at their high-end trim and ignore wireless lighting control commands, unless a normal-power-sensed (NPS) broadcast is received at least every 8 seconds.</li> <li>Using the CLAIRITY+ mobile app, EM devices must be associated with a group that includes a normal power sensing device to receive NPS broadcasts.</li> <li>Only non-emergency rPP20, rLSXR, rSBOR, rSDGR, and nLight AIR luminaires with version 3.4 or later firmware can provide normal power sensing for EM devices. See specification sheets for control devices and luminaires for more information on options that support normal power sensing.</li> </ul>

nLight Wired control Accessories	
Wall Switches	Model Number
On/Off two pole & Raise/Lower CCT	<a href="#">nPODMA 2P DX CCT (color)</a>
On/Off, 4 scene control, Dimming, TUWH	<a href="#">nPODMA 4S DX EDUTW (color)</a>
On/Off, 4 scene control, TUWH	<a href="#">nPODMA 4S EDUTW (color)</a>
Graphic Touchscreen	<a href="#">nPOD TOUCH (color)</a>

**SECONDARY POWER OPTION**

**Battery Packs**

The PS1055LCP battery is integral to the fixture and comes standard with a remote test switch and self-diagnostics. Only direct light portion operated by emergency, as indicated below.

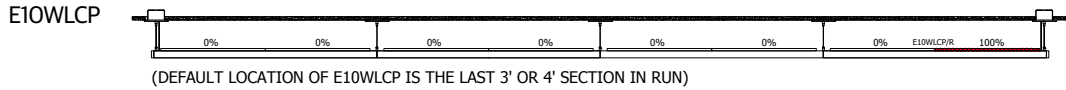

**Secondary Circuits**

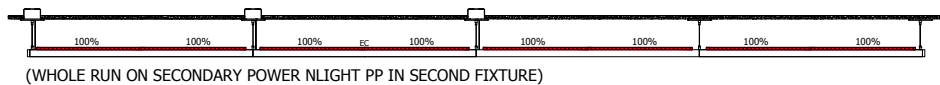
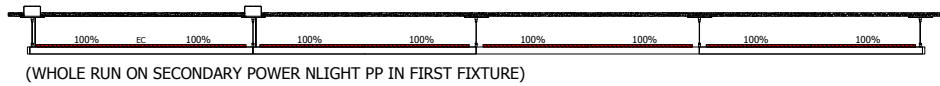
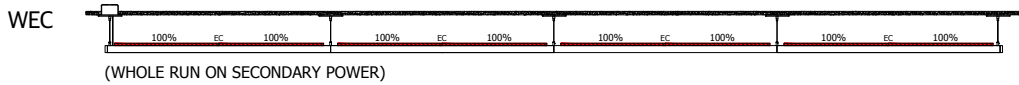
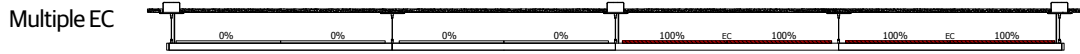
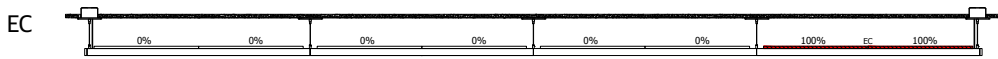

**How to Estimate Delivered Lumens in Emergency Mode**  
Use the formula below to estimate the delivered lumens in emergency mode  
**Delivered Lumens = 1.25 x P x LPW**  
P = 10W for PS1055LCP  
LPW = Lumen per watt rating of the luminaire This information is available on page 1 of this spec sheet or appropriate IES file.

Section Length	E10WLCP	EC
U2	None	Entire unit
U3	None	Entire unit
U4	Entire unit	Entire unit
U5	Last 3'	Entire unit
U6	Last 3'	Entire unit
U7	Last 4'	Entire unit
U8	Last 4'	Entire unit

**Remote GTD Mounting Option**

Recessed in ceiling. Consult factory for other ceiling types or canopy options. 6 foot flexible conduit included, GTD option should be mounted within 6 feet of junction box above fixture.

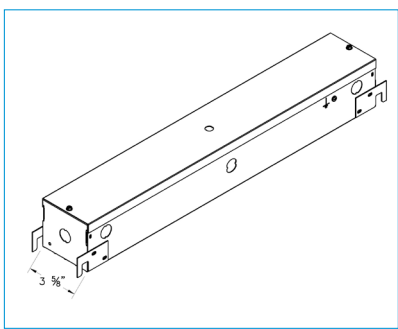
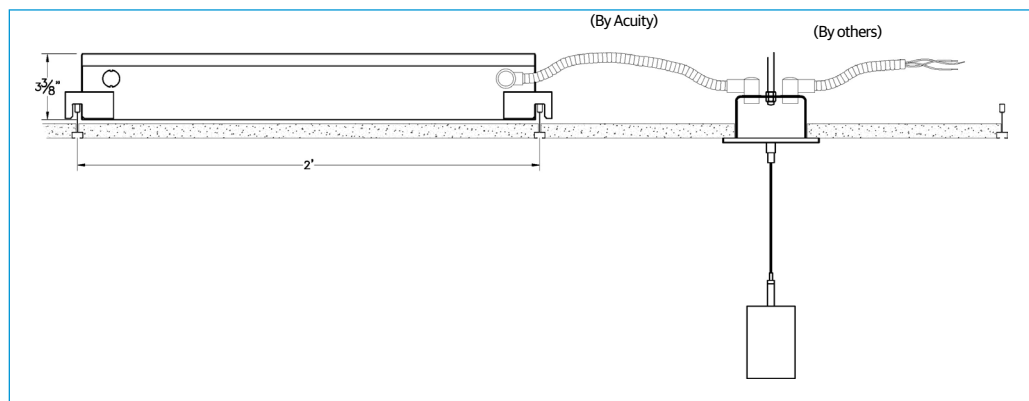

**Accessible Ceiling**

## SPECIFICATIONS

### Housing

One-piece extruded aluminum housing

### Finish

Standard colors for fixtures and end caps are polyester powder coated white, black, or silver with satin sheen. Consult factory for custom colors and RAL color options.

### Optics (Distribution)

Indirect batwing (BW) and Asymmetric (AS) distributions incorporate injection molded, optical grade, UV-resistant acrylic optic.

### Lenses/Shielding

Clear acrylic, dust cover (DC), frosted, acrylic dust cover (DCF), Extruded acrylic top glow lens (TGLD).

### LED Components

Multiple lumen packages available with 2700K, 3000K, 3500K, 4000K and 5000K CCT. The Acuity Brands circuit boards for the linear LED components use a precise binning algorithm which creates a consistent color temperature from board to board. The color a variation of no greater than a 2.5 Step MacAdam (2.55DECM) along the black body locus from board to board.

### Electrical

Long-life LEDs, coupled with high-efficiency drivers, provide superior quantity and quality of illumination for extended service life. 90% LED lumen maintenance at 60,000 hours (L90/60,000).

### Controls System Networking Options

Optional integrated nLight® controls make each fixture addressable - allowing it to digitally communicate with other nLight enabled controls such as dimmers, switches, occupancy sensors, and photocontrols. connection to nLight is simple. It can be accomplished with remote nLight AIR wireless or through standard Cat-5 cabling. (cabling "by others") nLight offers unique plug-and-play convenience as devices and luminaires automatically discover each other, while nLight AIR is commissioned easily through an intuitive mobile app.

### Battery (Optional)

Integral emergency battery (E10WLCP) for operation of 90 minutes. Emergency battery pack, 10W, Linear Constant Power Certified in CA Title 20 MAEDBS.

Remote generator transfer device (GTD) works in conjunction with an auxiliary generator or a central inverter system to power fixtures for safe egress lighting.

### Dimming Drivers

Factory tuned constant current electronic dimming driver is standard. Flicker free dimming available down to <1%. LED drivers perform within the recommended operating areas for flicker as a function of frequency and modulation (%) IEEE Standard 1789-2015 (IEEE Recommended Practices for Modulating Current in High-Brightness LEDs for Mitigating Health Risks to Viewers), in typical operating conditions at representative dimming levels. Electrical specifications at maximum driver load: PF > 0.9 and THD <20%. Meets FCC Title 47 Class A or Class B. Other available drivers include Lutron and DALI protocol drivers. All drivers are RoHS compliant.

### Environment

Suitable for damp location. Indoor use only.

### Certification

CSA certified to meet U.S. and Canadian standards (UL1598 and UL8750).

### Ambient Operating Temperature

-20°C (-4°F) to +25°C (+77°F).

### Government Procurement

BAA - Buy America(n) Act: Product qualifies as a domestic end product under the Buy American Act as implemented in the FAR and DFARS. Product also qualifies as manufactured in the United States under DOT Buy America regulations.  
BABA - Build America Buy America: Product qualifies as produced in the United States under the definitions of the Build America, Buy America Act. Please refer to [www.acuitybrands.com/buy-american](http://www.acuitybrands.com/buy-american) for additional information.

### Fixture Weight

0.8 lbs per foot, less packaging.

### Warranty

5-year limited warranty. This is the only warranty provided and no other statements in this specification sheet create any warranty of any kind. All other express and implied warranties are disclaimed. Complete warranty terms located at: [www.acuitybrands.com/support/warranty/terms-and-conditions](http://www.acuitybrands.com/support/warranty/terms-and-conditions)

**Note:** Actual performance may differ as a result of end-user environment and application.

All values are design or typical values, measured under laboratory conditions at 25 °C.

Specifications subject to change without notice.