

SLOT 2

SURFACE DIRECT

HIGHLIGHTS

- 300 to 1500 lumens per foot Direct
- Up to 117 Lumens per Watt
- 5 direct distributions: Lambertian, Batwing, Wall Wash Wall Graze or Asymmetric
- Multiple lens treatment options include Continuous, Drop, in 1/2", 1" or 1 1/2" and Edge View
- Shielding provided by optional deep cell baffle
- Integrated control with optional nLight or nLight Air for system networking
- Driver options for Dim to Dark, 1% or 10% minimum dimming
- White, black or silver paint with satin finish
- Declare listed
- UGR data available on page 3

DIMENSIONS

See page 5 for additional details.

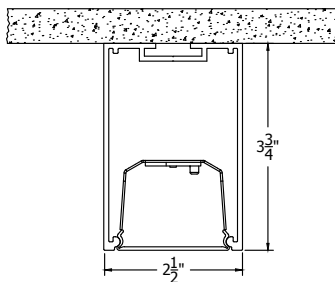

FIXTURE PERFORMANCE

Nominal Lumens/Foot	Direct							
	300LMF	400LMF	600LMF	800LMF	1000LMF	1200LMF	1400LMF	1500LMF
Delivered Lumens/Foot	271	367	547	702	908	1060	1248	1368
Input Watts/Foot	2.38	3.14	4.68	6.27	7.98	9.85	11.93	13.07
Lumens/Watt	114	117	117	112	114	108	105	105

Based on a 4ft 35K fixture with standard lambertian distribution



DIRECT DISTRIBUTION

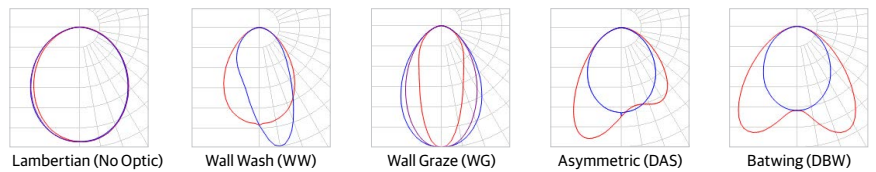

DIFFUSERS/SHIELDING

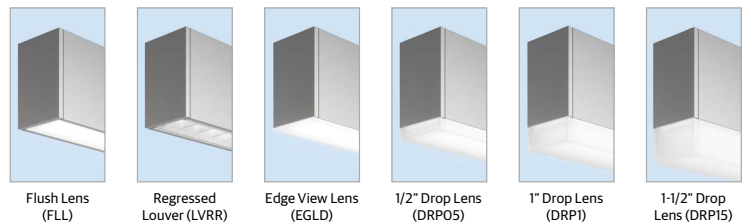

ORDERING

Example: S2SD LLP 32FT MSL8 90CRI 35K 800LMF MIN1 FLL SCT MVOLT WHTT ZT

Series	Linear Plan	Total Run Length	Max Section Length	Direct Light Source Color Rendering	Direct LED Color Temp	Direct Lumen Output	Direct Distribution (Optics)
S2SD Slot 2 Surface Direct (Formerly S2LS)	LLP Linear Longest Possible LCB Linear Center Balanced LSL Longest Same Length For more information on linear plans, see page 4.	_FT Specify Continuous Run Length (in 1" increments, 2' minimum) Unit length may affect available options. For runs longer than 8FT: ALWAYS order the run by the TOTAL RUN LENGTH. Ordering the sections individually will not provide the correct joining hardware to allow connection in the field.	MSL2 2FT Length MSL3 3FT Length MSL4 4FT Length MSL5 5FT Length MSL6 6FT Length MSL7 7FT Length MSL8 8FT Length	80CRI 80 CRI 90CRI 90 CRI	27K 2700K 30K 3000K 35K 3500K 40K 4000K 50K 5000K	300LMF 300 Lumens per Foot 400LMF 400 Lumens per Foot 600LMF 600 Lumens per Foot 800LMF 800 Lumens per Foot 1000LMF 1000 Lumens per Foot 1200LMF 1200 Lumens per Foot 1400LMF 1400 Lumens per Foot 1500LMF 1500 Lumens per Foot _LMF Specify Lumens between 300LMF - 1500LMF in 50LMF increments	(blank) Lambertian WW Wallwash Distribution WG Wall Graze Distribution DBW Direct Batwing Distribution DAS Direct Asymmetric Distribution Direct Distribution options are only available with FLL lens.

Switching	Minimum Dimming Level	Direct Shielding	Voltage	Finish	Emergency Options
SCT Single Circuit	NODIM¹ Non Dimming MINI Constant Current, Dimming To 1% MINIO² Constant Current, Dimming To 10% DARK Constant Current, Dimming To 0.1% 1. Not available with Control Input options. 2. MINIO is not available with DALI, ECOD or ECOD2.	FLL Flush Lens (Default) LVR¹ Regressed Louver LVRRA¹ Regressed Louver, Natural Aluminum EGLD² Edge Glow, Direct DRPO5³ Drop Lens, 1/2" DRP1² Drop Lens, 1" DRP15³ Drop Lens, 1-1/2" CLL⁴ Continuous Flush Lens 1. Not available with NLTAIR2. Only available in whole foot increments. 2. EGLD is not available with E10WLCP, GTD, NLTAIR2 or sensors. Only available in whole foot increments. 3. Drop lenses are only available in whole foot increments. They are not available with E10WLCP or GTD. 4. CLL is not available with WW, WG, DBW or DAS.	MVOLT Multi-Volt, 120-277 120 120V 277 277V 347¹ 347V 1. 347 is only available with ZT. 347 is not available with emergency options or sensors.	WHTT White (Satin) BLKT Black (Satin) SLVT Silver (Satin) RALTB¹ RAL Paint Finish RALTB is for pricing only. Replace with applicable RAL number & finish when placing order.	(blank) No Emergency Options _E10WLCP¹ # of 10W Battery Packs, Constant Power, Self Diagnostics, T20 Compliant WEC² Emergency Circuit for Entire Run _EC³ # of Emergency Circuits GTD⁴ Generator Transfer Device (Remote mounted) 1. E10WLCP is not available in units under 6'. E10WLCP with NLTAIR2 is only available in units 7'-8'. It's not available with EGLD, DRPO5, DRP1, DRP15 or sensors. 2. WEC is not available with sensors. 3. EC powers entire unit. 4. GTD is remote mounted. (See more information on page 9.) GTD is not available with MVOLT, 347, EGLD, DRPO5, DRP1 or DRP15.

Control Input	Primary Sensor	Secondary Zone	Tertiary Zone	Options
(blank) Non-Dimming ZT 0-10V NLIGHT nLight Wired NLTAIR2¹ nLight Air 2 Wireless Enabled DALI² DALI ECOD³ Lutron EcoSystem Digital Driver 1. NLTAIR2 can be used as a normal power sensing device for nLight Air devices and luminaires with EM emergency options. It is not available with NODIM or WL. NLTAIR2 with DCT fixtures cannot be less than 4'. 2. DALI is only available with DARK. DALI is not available with sensors. 3. ECOD is only available with MINI. It is not available with E10WLCP & sensors. It is only available with 300LMF, 600LMF, 1000LMF or 1500LMF.	(blank) No sensors NS_ Primary Zone with No Sensor (Specify length in feet) ADC¹ Daylight Dimming Sensor PDT¹ Dual Technology Occupancy Sensor, PIR and Microphonics Sensor APIR² Passive Infrared Occupancy and Daylight Dimming Sensor APDT² Dual Technology Occupancy and Daylight Dimming Sensor Sensors are only available with FLL and fixtures 4' and above. Please see page 8 for more details. 1. ADC & PDT are available with ZT or NLIGHT. 2. APIR & APDT are available with ZT, NLIGHT or NLTAIR2.	(blank) No Sensors or Secondary Zone SNS_ Secondary Zone with No Sensor (Specify length in feet) SADC¹ Daylight Dimming Sensor, Secondary Zone SPDT¹ Dual Technology Occupancy Sensor, PIR and Microphonics Sensor, Secondary Zone SAPIR² Passive Infrared Occupancy and Daylight Dimming Sensor, Secondary Zone SAPDT² Dual Technology Occupancy and Daylight Dimming Sensor, Secondary Zone Sensors are only available with FLL and fixtures 4' and above. Please see page 8 for more details. 1. ADC & PDT are available with ZT or NLIGHT/ 2. APIR & APDT are available with ZT, NLIGHT or NLTAIR2.	(blank) No Tertiary Zone TNS_ Tertiary Zone (Specify length in feet)	BAA Buy America(n) Act and/or Build America Buy America Qualified

NOTE: Unit length and lumen outputs may affect available options.

PHOTOMETRICS

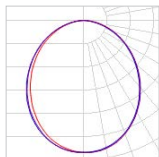

Test Report: ISF 23168P741
IES LM79-08
S2SD U4 80CRI 35K 1000LMF
Lumens: 3631
Wattage: 31.91
Efficacy: 113.78

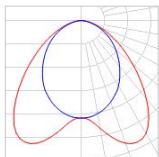

Test Report: ISF 23168P741
IES LM79-08
S2SD U4 80CRI 35K 1000LMF DBW FLLC
Lumens: 2298
Wattage: 31.91
Efficacy: 72.02

EXPECTED LIFE: L90 @ 60,000 HOURS
CALCULATED LIFE: L80 @ 120,000 HOURS

CCT SCALING CHART

CCT	CRI	MULTIPLIER
27K	80CRI	0.94
30K	80CRI	0.97
35K	80CRI	1.00
40K	80CRI	1.02
50K	80CRI	1.03
27K	90CRI	0.79
30K	90CRI	0.81
35K	90CRI	0.83
40K	90CRI	0.84
50K	90CRI	0.89

Lumen scaling charts can be used to approximate the lumen values at different Kelvin temperatures, color rendering indices, optics or shielding.
Example: Find base lumen value x multiplier value = new lumen value

OPTICAL SCALING CHARTS

DOWNLIGHT	
DISTRIBUTIONS	MULTIPLIER
WW	0.76
WG	0.85
DBW	0.71
DAS	0.78

*Base fixture with Lambertian distribution and flush lens

Lumen Package	UGR (70% 50% 20% reflectance using a 4H x 8H room size)										
	CROSSWISE										
	Lambertian	DBW	WG	WW	CLL	DPRO5	DRP1	DRP15	EGLD	LVR	LVRRA
300LMF	20.9	17.8	18.3	12.2	21.3	19.2	17.2	15.7	21	9.3	9.1
400LMF	22	18.9	19.4	13.2	22.4	20.2	18.2	16.8	22	10.3	10.2
600LMF	23.4	20.2	20.7	14.6	23.7	21.6	19.6	18.2	23.4	11.7	11.6
800LMF	24.2	21.1	21.6	15.5	24.6	22.5	20.5	19.1	24.3	12.6	12.5
1000LMF	25.1	22	22.5	16.4	25.5	23.4	21.4	19.9	25.2	13.5	13.3
1200LMF	25.7	22.5	23	16.9	26	23.9	21.9	20.5	25.7	14	13.9
1400LMF	26.2	23.1	23.6	17.5	26.6	24.5	22.5	21	26.3	14.6	14.5
1500LMF	26.5	23.4	23.9	17.8	26.9	24.8	22.8	21.4	26.6	14.9	14.8
Lumen Package	ENDWISE										
	Lambertian	DBW	WG	WW	CLL	DPRO5	DRP1	DRP15	EGLD	LVR	LVRRA
	300LMF	21.6	18.1	17.3	14.6	20.8	21	22	21.7	20.7	4.7
400LMF	22.6	19.1	18.4	15.7	21.9	22	23	22.7	21.8	5.7	5.6
600LMF	24	20.5	19.8	17.1	23.3	23.4	24.4	24.1	23.2	7.1	7
800LMF	24.9	21.4	20.6	17.9	24.2	24.3	25.3	25	24	8	7.8
1000LMF	25.8	22.3	21.5	18.8	25	25.2	26.2	25.9	24.9	8.9	8.7
1200LMF	26.3	22.8	22	19.4	25.6	25.7	26.7	26.4	25.4	9.4	9.3
1400LMF	26.9	23.4	22.6	19.9	26.2	26.3	27.3	27	26	10	9.8
1500LMF	27.2	23.7	22.9	20.2	26.5	26.6	27.6	27.3	26.3	10.3	10.2

*Calculations based on a 4 foot fixture @ 35K 80CRI

**UGR varies based on luminaire options and is affected by application dependent parameters. Numbers depicted here are considered "Luminaire-UGR" and/or "Point-UGR" values.

To determine a more precise maximum UGR value ("Application-UGR"), a full lighting design layout should be completed with the selected luminaire

*** Click here from more information: [UGR FAQ](#)

LINEAR PLAN

Mark Lighting offers the ability to provide a continuous run plan to suit your requirements by optionally offering three different methods of configuration.

LLP- Linear Longest Possible

In this configuration, the longest length available is optimized, resulting in the fewest segments and mounting locations. Caution should be used where balanced appearance is a concern. Example: 20 FT run would have 2, 8 FT segments and 1, 4 FT segment at the end of the run.



LCB- Linear Center Balanced:

This configuration incorporates the longest center segment(s) along with any additional lengths required to fill the run length, added to the run ends. Example: 16 FT run would have 2, 4 FT segments (one at each end) and 1, 8 FT segment in the center.

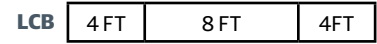

LSL- Linear Same Length:

In this configuration, each segment is the same length and is standardized based on the longest length available and is the only option provided. Because it is dependent on one segment length and there are mathematical limitations on what overall row lengths can be achieved. Example: 20 FT row would be achieved with 5, 4 FT long segments equaling 20 FT (nominal).

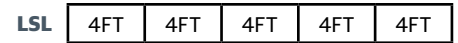

Total Run Length

This system is not modular. Runs longer than 8FT will be automatically configured with left, intermediate and right sections, based on how you specify the TOTAL RUN LENGTH and MAXIMUM SECTION LENGTH parameters in the ordering information. Always order the total run length, not the individual sections.

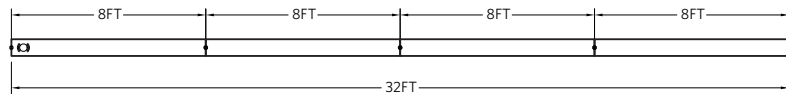

Example: This run must be ordered as 1pc "S2SD LLP 32FT MSL8..."

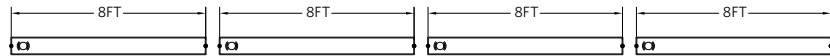

Example: If you order as 4pcs "S2SD LLP 8FT MSL8... you will receive these INDIVIDUAL sections that cannot be joined together

Maximum Section Length

The run will be broken out using as many sections at the chosen maximum section length as possible. Shorter sections will then complete the desired run length.

Examples:

S2SD LLP 21FT MSL5... = 5FT / 4FT / 4FT / 4FT / 4FT

S2SD LLP 21FT MSL6... = 6FT / 6FT / 5FT / 4FT

S2SD LLP 21FT MSL7... = 7FT / 7FT / 7FT

S2SD LLP 21FT MSL8... = 8FT / 8FT / 5FT



INDIVIDUAL FIXTURES					
ORDERED LENGTH	"A" O.A.L.	"B1" O.C.	"B2" O.C.	"C" FROM END	APPROX. WEIGHT
2FT	2'- 0 9/16"	2"	1'- 2"	3 1/4"	1.6 LBS
3FT	3'- 0 9/16"	2"	1'- 2"	3 1/4"	2.4 LBS
4FT	4'- 0 9/16"	2"	1'- 2"	3 1/4"	3.2 LBS
5FT	5'- 0 9/16"	2"	1'- 2"	3 1/4"	4 LBS
6FT	6'- 0 9/16"	2"	1'- 2"	3 1/4"	4.8 LBS
7FT	7'- 0 9/16"	2"	1'- 2"	3 1/4"	5.6 LBS
8FT	8'- 0 9/16"	2"	1'- 2"	3 1/4"	6.4 LBS

Mounting

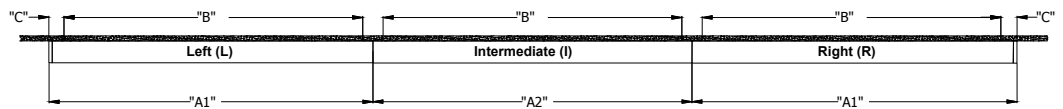
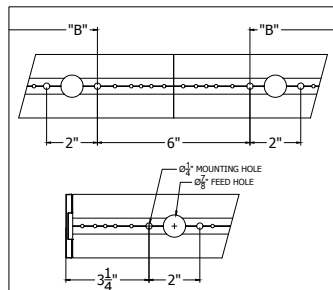

RUN LAYOUT					
ORDERED LENGTH	"A1" O.A.L.	"A2" O.A.L.	"B" O.C.	"C" FROM END	APPROX. WEIGHT
4FT	4'- 0 1/4"	4'-0"	3'-6"	3 1/4"	3.2 LBS
5FT	5'- 0 1/4"	5'-0"	4'-6"	3 1/4"	4 LBS
6FT	6'- 0 1/4"	6'-0"	5'-6"	3 1/4"	4.8 LBS
7FT	7'- 0 1/4"	7'-0"	6'-6"	3 1/4"	5.6 LBS
8FT	8'- 0 1/4"	8'-0"	7'-6"	3 1/4"	6.4 LBS

SHIELDING, OPTICS & CONNECTORS

Direct Shielding

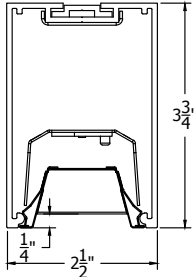

Louver (LVRR)

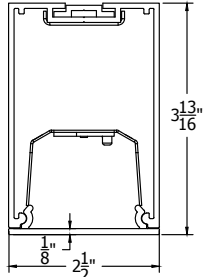

Edge Glow Lens (EGLD)

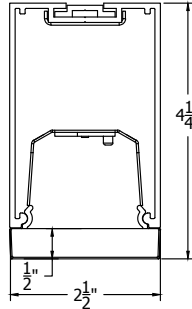

1/2" Drop Lens (DRP05)

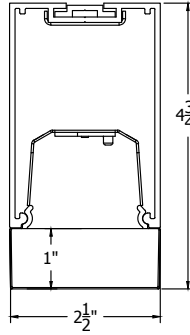

1" Drop Lens (DRP1)

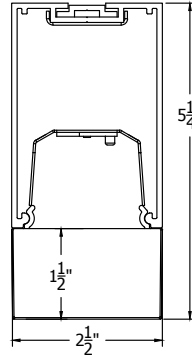

1-1/2" Drop Lens (DRP15)

Direct Optics

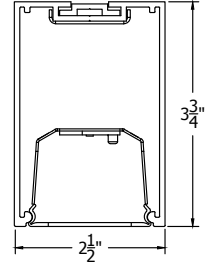

Optical Film with Co-Extruded Lens (Batwing (DBW), Asymmetric (DAS), Wall Graze (WG), Wall Wash (WW))

Run Patterns, Corners and Junction

Patterns can be configured in 1' increments with illuminated L, T & X connectors with standard 2' corner. L connectors are available in 40-160 degrees in 1 degree increments. T & X connectors available in 90 degrees. For custom angles, corner or junction lengths, consult factory. See separate pattern spec sheet for more details.

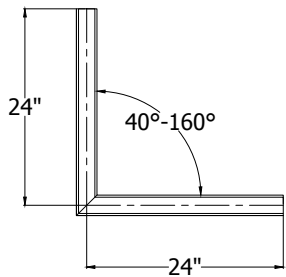

L Connector

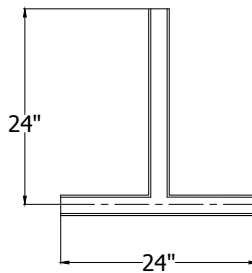

T Connector

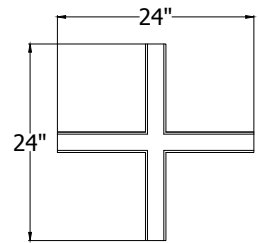

X Connector

INTELLIGENT LUMINAIRE TECHNOLOGY GUIDE

Choose nomenclature from these columns		Dimming Range	Notes		
Driver Configurations	Minimum Dimming Level	Control Input			
	NO DIM	+	(blank)	-	No 0-10V leads from the driver.
	MINIO	+	ZT	100 to 10%	
	MIN1	+	ZT	100 to 1%	
	MIN1	+	NLIGHT	100 to 1%	
	MIN1		ECOD	100 to 1%	Lutron Hi-lume 1% EcoSystem LED Driver with Soft-on, Fade-to-Black (model LDE1)
	DARK		ZT	100 to 0.1%	
	DARK		NLIGHT	100 to 0.1%	
DARK		DALI	100 to 0.1%	"Compatible with DALI. Formerly (EDB & EDAB) nomenclature." Logarithmic dimming	

Choose nomenclature from these columns		Sensor	Notes		
Control / Sensor Configurations	Control Input	Sensor			
	ZT	+	ADC =	MSD ADC	Automatic dimming control integral photocell.
	ZT	+	PDT =	MSD PDT 7	Dual technology integral occupancy sensor.
	ZT	+	APIR =	MSD 7 ADC	PIR integral occupancy sensor with automatic dimming control photocell.
	ZT	+	APDT =	MSD PDT 7 ADC	Dual technology integral occupancy sensor with automatic dimming control photocell.
	NLIGHT	+	(blank) =	nIO EZ PH	nLight enabled only. No onboard sensor.
	NLIGHT	+	ADC =	nIO EZ PH + nES ADCX	Automatic dimming control integral photocell. nLight enabled.
	NLIGHT	+	PDT =	nIO EZ PH + nES PDT 7	360° Dual technology integral occupancy sensor. nLight enabled.
	NLIGHT	+	APIR =	nIO EZ PH + nES 7 ADCX	360° PIR integral occupancy sensor with automatic dimming control photocell. nLight enabled.
	NLIGHT	+	APDT =	nIO EZ PH + nES PDT 7 ADCX	360° Dual technology integral occupancy sensor with automatic dimming control photocell. nLight enabled.
	NLTAIR2	+	(blank) =	RIO EZDL EXT900 ACWH 90D G2	nLight AIR enabled only. No onboard sensor.
	NLTAIR2	+	APIR =	RES7 EXT900 ACWH 90D G2	PIR integral occupancy sensor with automatic dimming control photocell. nLight AIR enabled.
	NLTAIR2	+	APDT =	RES7 PDT EXT900 ACWH 90D G2	Dual technology integral occupancy sensor with automatic dimming control photocell. nLight AIR enabled.

For more information, please consult our technical guides for [nLight](#) or [nLight Air](#).

UL924 Sequence of Operation

The below information applies to all nLight AIR devices with an EM option.

- EM devices will remain at their high-end trim and ignore wireless lighting control commands, unless a normal-power-sensed (NPS) broadcast is received at least every 8 seconds.
- Using the CLAIRITY+ mobile app, EM devices must be associated with a group that includes a normal power sensing device to receive NPS broadcasts.
- Only non-emergency rPP20, rLSXR, rSBOR, rSDGR, and nLight AIR luminaires with version 3.4 or later firmware can provide normal power sensing for EM devices. See specification sheets for control devices and luminaires for more information on options that support normal power sensing.

nLight® Wired Control Accessories
Order as separate catalog number

Wall Switches	Model Number
On/Off single pole	nPODMA (color)
On/Off two pole	nPODMA 2P (color)
On/Off single pole, dimming	nPODMA DX (color)
On/Off two pole, dimming	nPODMA 2P DX (color)
On/Off, two level	nPODMA 2L (color)
Graphic touchscreen	nPOD TOUCH (color)

For more information see [nPOD](#) and [nPOD TOUCH](#) spec sheets

nLight AIR® Control Accessories
Order as separate catalog number

Wall Switches	Model Number
On/Off single pole	rPODBA (color)
On/Off two pole	rPODBA 2P (color)
On/Off single pole, dimming	rPODBA DX (color)
On/Off two pole, dimming	rPODBA 2P DX (color)
On/Off, 4 scene control	rPODBA 4S (color)

For more information see [rPOD](#) spec sheets

INTEGRATED SENSOR LAYOUT

For runs longer than 8FT:
ALWAYS order the run by the TOTAL RUN LENGTH. Ordering the sections individually will not provide the correct joining hardware to allow connection in the field.

CORRECT:

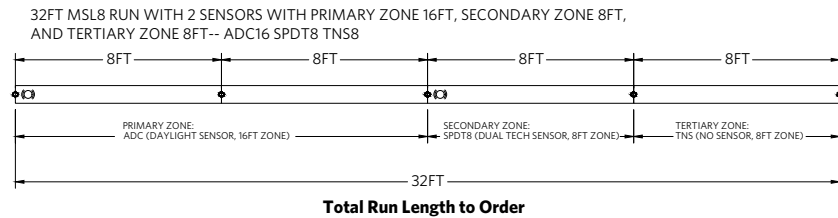
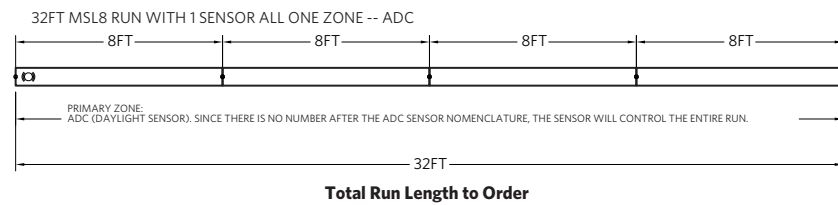
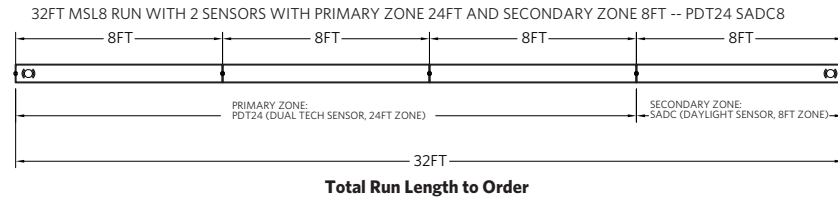

INCORRECT:

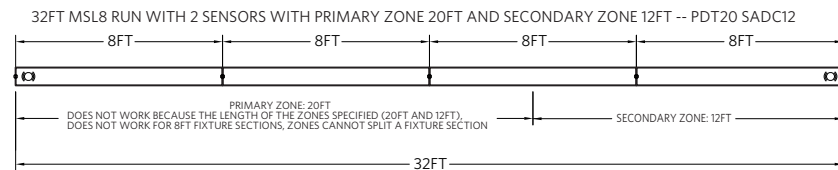
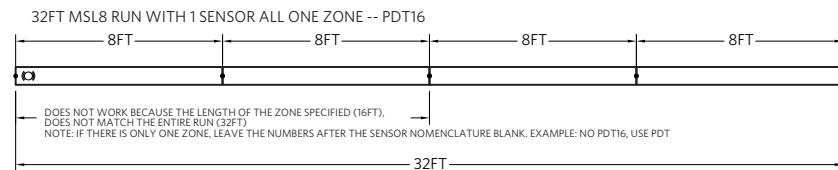

Notes:

- Only one sensor per zone
- At the most, the entire run can only have 2 sensors (thus 2 sensors zones at the most)
- Sensor zone can not split fixture sections
- No overlapping zones

OCCUPANCY DETECTION COVERAGE

At the 7.5 ft (2.9 m) hanging height of a typical pendant mount fixture the sensor provides 10 ft (3.05 m) radial detection of small motion. At a 9 ft (2.74 m) hanging height the radius is 12 ft (3.66 m) for small motion.

Adequate for walking motion detection from mounting heights between 7.5 ft (2.29 m) and 20 ft (6.10 m).

Initial detection will occur earlier when walking across sensor's field of view than when walking directly at sensor.

Initial detection of walking motion into long coverage segment will occur at distances of 2x the mounting height up to 15 ft (4.57 m) and 1.75x up to 20 ft (6.10 m). Lens assembly rotates 15° to enable adjustment in order to line up long segments.

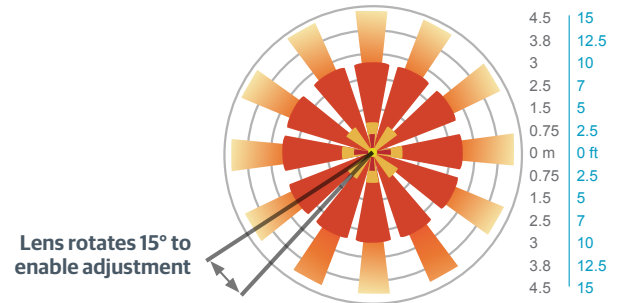

Integrated Controls

Optional nLight® integrated controls make Slot LED luminaires addressable- allowing them to digitally communicate with other nLight enabled controls such as dimmers, switches, occupancy sensors and photocontrols. Simply connect all the nLight enabled control devices using standard CAT5 Cabling (included).

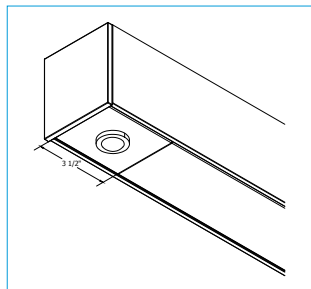

Occupancy Sensor and/or Photocell

nLight Air Wireless Antenna Location

Note: Antenna will be shipped separately and will need to be attached to the coax connector.

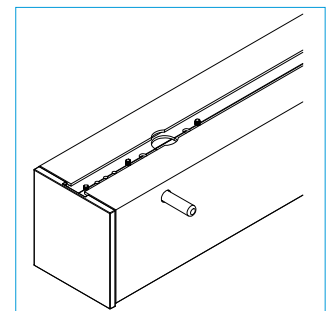

EMERGENCY OPTIONS

Emergency Battery Packs

The [PS1055LCP](#) battery is integral to the fixture and comes standard with a remote test switch and self-diagnostics. Only direct light portion operated by emergency, as indicated below.

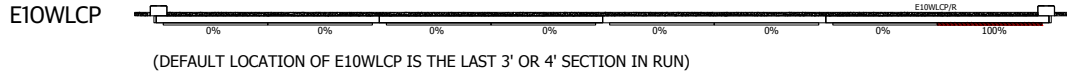

Emergency Circuits

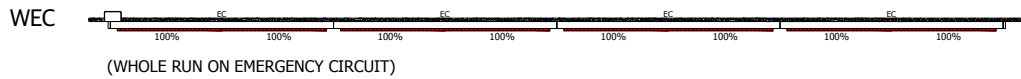
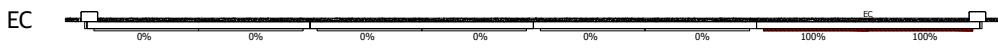

How to Estimate Delivered Lumens in Emergency Mode
Use the formula below to estimate the delivered lumens in emergency mode
Delivered Lumens = 1.25 x P x LPW
P = 10W for PS1055LCP
LPW = Lumen per watt rating of the luminaire This information is available on page 1 of this spec sheet or appropriate IES file.

Section Length	E10WLCP	EC
U2	None	Entire unit
U3	None	Entire unit
U4	Entire unit	Entire unit
U5	Last 3'	Entire unit
U6	Last 3'	Entire unit
U7	Last 4'	Entire unit
U8	Last 4'	Entire unit

Remote GTD Mounting Option

Recessed in ceiling. Consult factory for other ceiling types or canopy options. 6 foot flexible conduit included, GTD option should be mounted within 6 feet of junction box above fixture.

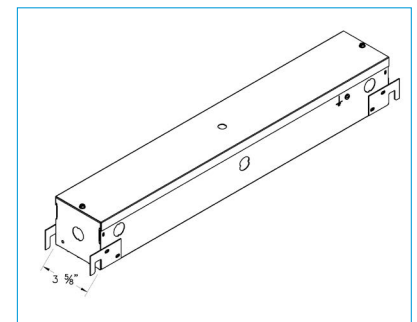
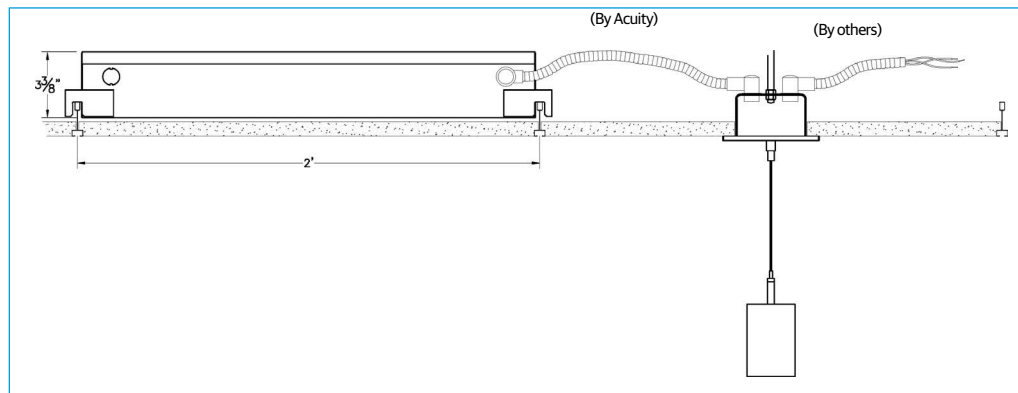

Accessible Ceiling

SPECIFICATIONS

Housing

One-piece extruded aluminum housing

Finish

Standard colors for fixtures and end caps are polyester powder coated white, black, or silver with satin sheen. Consult factory for custom colors and RAL color options.

Optics (Distribution)

Wall Wash (WW), Wall Graze (WG), Direct Batwing (DBW) and Asymmetric (DAS) incorporate co-extruded lenses and films.

Lenses/Shielding

Direct: Extruded acrylic lens, (FLL, CLL). Edge Glow lens, (EGLD), Aluminum regressed louver with either a powder coat finish (LVRR) or aluminum finish (LVRR). Extruded acrylic drop lens (DRP05, DRP1, DRP15).

LED Components

Multiple lumen packages available with 2700K, 3000K, 3500K, 4000K and 5000K CCT. The Acuity Brands circuit boards for the linear LED components use a precise binning algorithm which creates a consistent color temperature from board to board. The color a variation of no greater than a 2.5 Step MacAdam (2.55DECM) along the black body locus from board to board.

Electrical

Long-life LEDs, coupled with high-efficiency drivers, provide superior quantity and quality of illumination for extended service life. 90% LED lumen maintenance at 60,000 hours (L90/60,000).

Controls System Networking Options

Optional integrated nLight® controls make each fixture addressable - allowing it to digitally communicate with other nLight enabled controls such as dimmers, switches, occupancy sensors, and photocontrols. Connection to nLight is simple. It can be accomplished with remote nLight AIR wireless or through standard Cat-5 cabling. (cabling "by others") nLight offers unique plug-and-play convenience as devices and luminaires automatically discover each other, while nLight AIR is commissioned easily through an intuitive mobile app.

Emergency Battery (Optional)

Integral emergency battery (E10WLCP) for 90 minutes of operation. Emergency battery pack, 10W. Linear Constant Power Certified in CA Title 20 MAEDBS.

Remote generator transfer device (GTD) works in conjunction with an auxiliary generator or a central inverter system to power fixtures for safe egress lighting.

Dimming Drivers

Factory tuned constant current electronic dimming driver is standard. Flicker free dimming available down to <1%. LED drivers perform within the recommended operating areas for flicker as a function of frequency and modulation (%) IEEE Standard 1789-2015 (IEEE Recommended Practices for Modulating Current in High-Brightness LEDs for Mitigating Health Risks to Viewers), in typical operating conditions at representative dimming levels. Electrical specifications at maximum driver load: PF > 0.9 and THD <20%. Meets FCC Title 47 Class A or Class B. Other available drivers include Lutron and DALI protocol drivers. All drivers are RoHS compliant.

Environment

Suitable for damp location. Indoor use only.

Certification

CSA certified to meet U.S. and Canadian standards (UL1598 and UL8750).

Ambient Operating Temperature

-20°C (-4° F) to +25°C (+77°F).

Government Procurement

BAA - Buy America(n) Act: Product qualifies as a domestic end product under the Buy American Act as implemented in the FAR and DFARS. Product also qualifies as manufactured in the United States under DOT Buy America regulations.
BABA - Build America Buy America: Product qualifies as produced in the United States under the definitions of the Build America, Buy America Act. Please refer to www.acuitybrands.com/buy-american for additional information.

Fixture Weight

0.8 lb per foot, less packaging.

Warranty

5-year limited warranty. This is the only warranty provided and no other statements in this specification sheet create any warranty of any kind. All other express and implied warranties are disclaimed. Complete warranty terms located at: www.acuitybrands.com/support/warranty/terms-and-conditions

Note: Actual performance may differ as a result of end-user environment and application.

All values are design or typical values, measured under laboratory conditions at 25 °C.

Specifications subject to change without notice.