



HOLOPHANE[®]
LEADER IN LIGHTING SOLUTIONS

sitelink[®]
by **HOLOPHANE**



**Acuity Brands.**



A Revolutionary Pole with a Patented Track System

Sitelink offers unparalleled versatility for complete site coordination and adaptability. Sitelink turns good designs into great designs that fully integrate all of the products found in today's public spaces onto one single structure. Sitelink accommodates loading for future lighting requirements and accessories.





Contemporary Shaft

Decorative Shaft

Features and Benefits

Patented TracLoc™ System:

- + Provides future loading capabilities
- + Promotes ease of maintenance
- + Allows mounting adjustments to site condition
- + Enables flexibility and eliminates clutter

Stronger Construction:

- + Allows for more accessories
- + Provides excellent reliability
- + Enhances corrosion resistance with aluminum material

Finishes:

- + Premium paint and anodized finishes are available
- + Track system helps protect finish by eliminating need for straps and bands

Protected Wireways:

- + Four isolated wireways for low voltage, fiber optics, irrigation, etc.

Typical Applications

Street Lighting:

- + Downtown restoration
- + City streets
- + Schools and University
- + Residential areas

Commercial:

- + Waterfront developments
- + Commercial developments
- + Retail
- + Airports & public transit
- + Convention centers
- + Amusement parks and recreation
- + Sporting venues
- + Hotels and resorts

Interactive Station:

- + EV Charging stations
- + Static and interactive signage

The SiteLink Concept

The SiteLink pole is an extruded aluminum shaft with up to four self-contained tracks for mounting site equipment such as luminaires, banners, traffic lights, traffic control systems, communication systems, security cameras, cellular, and audiovisual equipment.

In addition, SiteLink can be utilized to anchor amenities such as traffic provisions and planters as well as a variety of other equipment that today or tomorrow's sites may require. SiteLink has been rigorously tested to meet the highest standards of pole and lighting standard requirements in the marketplace. SiteLink is designed per AASHTO-2013 to meet wind loading requirements throughout North America. All SiteLink accessory components must be installed with the proper equipment.

Equipment

Site equipment such as traffic lights, pedestrian signal equipment, security cameras and traffic signs can all fit the TracLoc system through the use of one of the several standard accessory components available.

Custom components can also be developed for more challenging designs, like meters and EV charging plates that require special attachments. In these instances, please contact your local Holophane factory sales representative for consultation.

TracLoc System

At the heart of the SiteLink Pole is the TracLoc System, which uses a dovetail track and TracNut™. The TracLoc system allows the installer to locate components in the field without preplanning. In addition, an installer can add products in the future without having to modify the pole, buy a new pole, or add components using unsightly straps and banding.

How it Works – Simple, Fast and Flexible

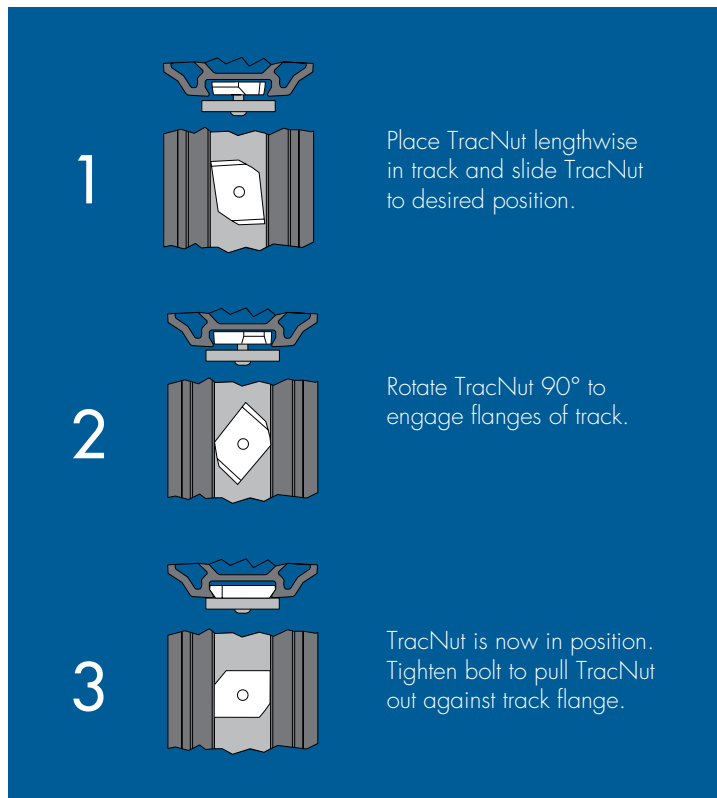

Why SiteLink?

Provides future loading capabilities

- + SiteLink accommodates future loading, which completely differentiates the product from traditional street poles.
- + The SiteLink pole system is robust; allowing as much as two to three times the additional pole loading as conventional aluminum poles available in the industry.
- + Fewer poles will be needed as the site evolves and additional equipment and accessories are needed.

SiteLink is easy to maintain

- + A hex-tool is all that is needed to securely lock, relocate or remove, the various SiteLink accessories and components.
- + The SiteLink system is easy to install and maintain which saves labor costs, as the site changes over time.



SiteLink eliminates street and site clutter

- + SiteLink preserves the design-intent of the site engineer by eliminating the need for unsightly bands and clamps that damage the surface of today's poles.
- + The adaptable SiteLink system will safely link new equipment and accessories to its structure without it looking like an afterthought.
- + SiteLink reduces the need for additional poles combining the load of multiple poles into one complete system, meaning less poles, and a better looking site.

SiteLink is a durable product

- + SiteLink poles are built for abuse and are highly durable using all aluminum.
- + SiteLink is available with security hex bolts to secure parts and components to the system.
- + SiteLink poles are available in premium paint and anodized finishes, which make them ideal for corrosive environments such as ports and waterfront applications.

Auxiliary Channels

SiteLink offers four auxiliary channels that can be accessed through the decorative base handholes. If the base plate or shoe base is used a transformer base will need to be used to gain access to wireways (see below).

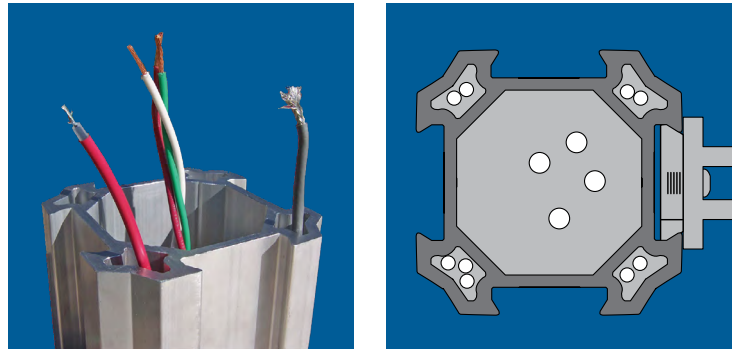

A typical cross section of a SiteLink pole shows line voltage delivered through the central core, low voltage in the auxiliary channels, with an accessory fastened onto one of four mounting tracks.

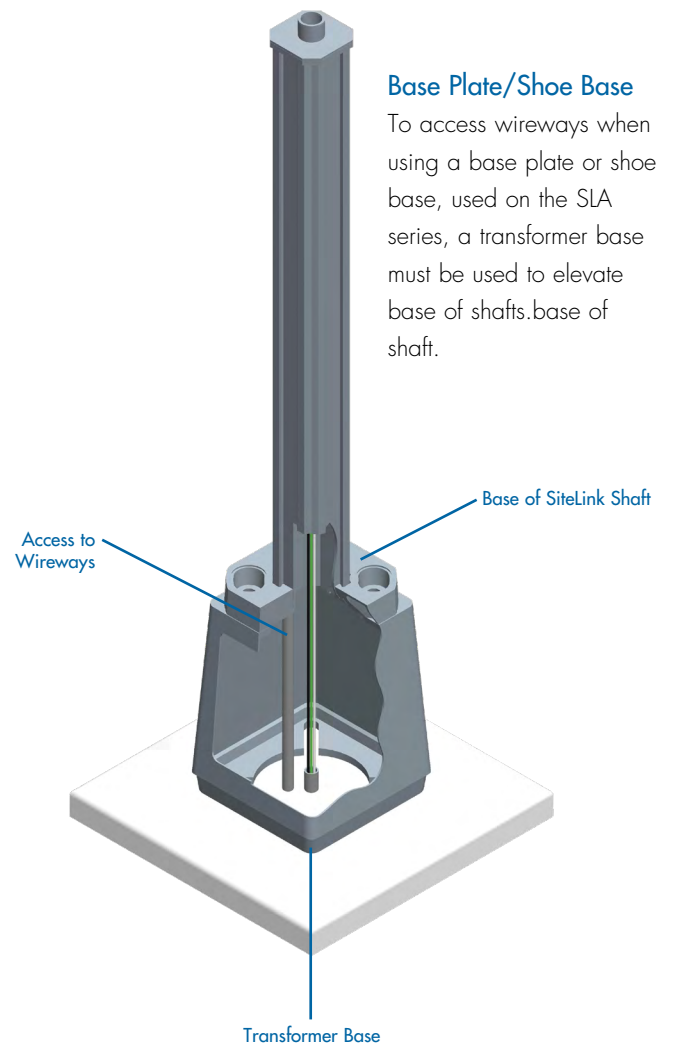

Adaptable & Flexible

SiteLink is compatible with just about any traditional pole accessory and lighting fixture. It is also adaptable so that communication systems, traffic control and security devices, and street amenities may be mounted to the versatile TracLoc System. This is accomplished through a variety of mounting hardware.

As your lighting and street plan evolves or your needs change, SiteLink poles offer the flexibility to accommodate the new requirements without your site looking like an afterthought or without the added costs of additional poles and labor associated with today's more conventional poles.



SiteLink Strength

Shaft Comparison: SiteLink 4" (SL4) Wadsworth Base (WDA)

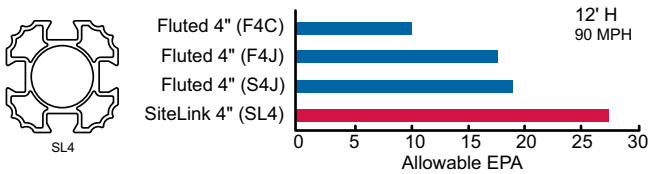

Shaft Comparison: SiteLink 5" (SL5) Wadsworth Base (WDA)

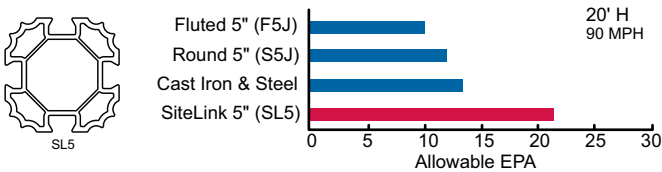

Shaft Comparison: SiteLink 6" (SL6) Wadsworth Base (WDA)

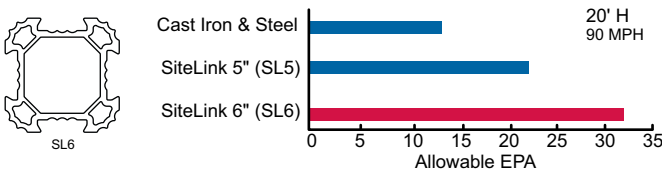

Shaft Comparison: T-Series & SL6/SL8 Base Plate or Shoe Base (SLA)

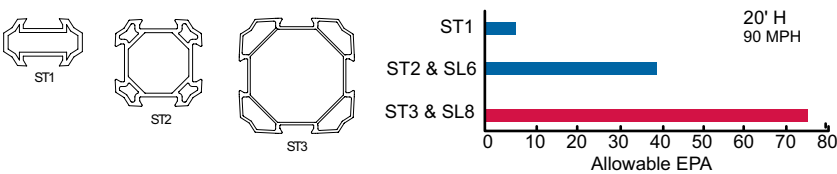

Wadsworth Base (WDA)



Shoe Base (SB)



Base Plate (BP)



Contemporary Shaft Style

The Contemporary Shaft Style provides a clean, architectural look available in three different sizes, made with high strength aluminum alloy, which is extruded to form the shaft profile and functional track system.

ST1:

One-piece, integral base plate or shoe base available with a 2-sided shaft.

ST2:

Heavy duty construction available with one-piece integral base plate or decorative base. A variety of two-piece clamshell bases are available.

ST3:

Heavy duty construction available with one-piece integral base plate or decorative base. A variety of two-piece clamshell bases are available to use with base plate or shoe base.



Light Duty (ST1)
Two track pole – 3" x 5"



Medium Duty (ST2)
Four track pole – 5.75" square

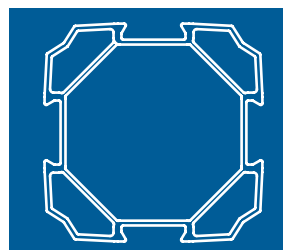

Heavy Duty (ST3)
Four track pole – 8.5" square



Decorative Shaft Style

The Decorative Shaft Style is fluted and can take on either a historical or modern appearance. The style is available in four fluted pole sizes. Each shaft size is made from high strength aluminum alloy, which is extruded to form the decorative fluted shaft profile and functional track system.

Structural Bases

Integral structural base with one-piece construction is available on the SL4, SL5 and SL6 with a variety of base styles. Ideal for lower pole heights with lighter duty requirements.

Clamshell Bases

Heavy duty pole construction with an integral shoe base or base plate is available on the SL5, SL6 and SL8. A variety of clamshell bases can be specified as a separate component. Ideal for higher pole heights and applications requiring additional strength.



Light Duty (SL4)
Four track pole – 4.5" square



Medium Duty (SL5)
Four track pole – 5.25" square



Heavy Duty (SL6)
Four track pole – 5.75" square



Heavy Duty (SL8)
Four track pole – 8.5" square

Structural Cast Aluminum Bases

A variety of structural bases have been engineered for the Sitelink platform. The decorative bases below are constructed from robust cast aluminum material and are welded into the structure of the Sitelink shaft. They are available in a several styles and sizes to be used with 8 to 30 foot Sitelink shafts.

Cast Aluminum Structural Bases									
Series	Diameter	Height	ST1	ST2	ST3	SL4	SL5	SL6	SL8
Sitelink SLA (Base Plate)	11"	3"	8'-20'						
	13"	3"		8'-30'					
	18.25"	3"			8'-30'				
Sitelink SLA (Shoe Base)	13"	5"					8'-30'		
	13"	5"						8'-30'	
	16.5"	5"							8'-30'
Charleston (CHA)	12"	40"				8'-18'			
	16"	44"				8'-18'	8'-22'	8'-22'	
Columbia (CLA)	17"	19"					8'-22'		
Chesapeake (CPA)	20"	39"					8'-22'		
Delaware (DAA)	15"	6"				8'-16'	8'-16'		
Fort Washington (FWA)	18"	22"					8'-14'		
Hamilton (HLA)	10"	42.5"				8'-18'			
Kentwood (KWA)	20"	50"					8'-20'		
North Yorkshire (NYA)	17"	25"				8'-16'	8'-30'	8'-30'	
Salem (SMA)	09"	27"				6'-12'			
	13"	45"				8'-22'			
Wadsworth (WDA)	17"	18.25"				8'-16'			
		19.25"					8'-22'	8'-22'	

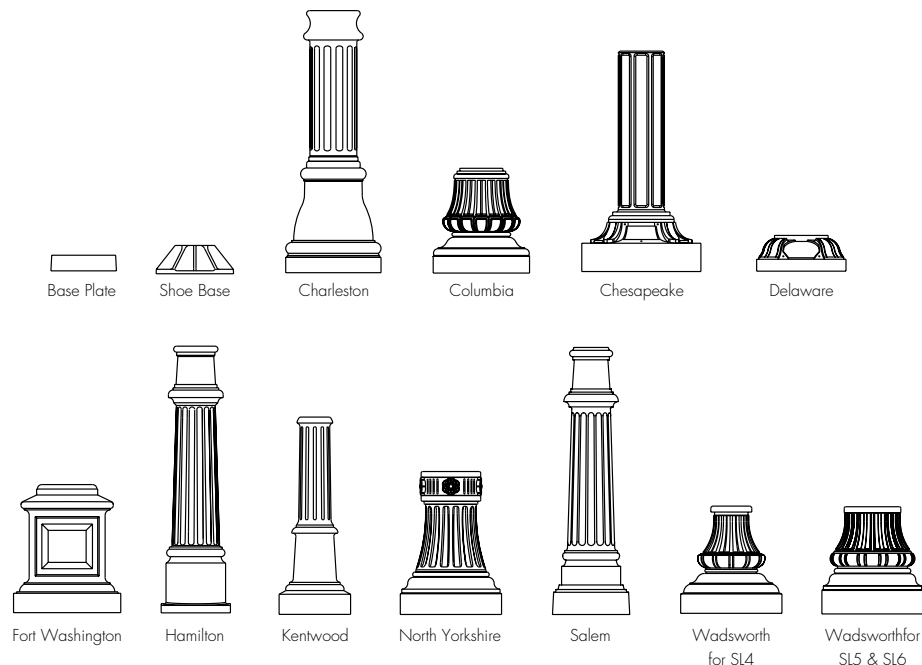

Clamshell Bases

Decorative clamshell bases are also available for the SiteLink platform in a several styles and sizes for shafts ranging from 8 to 30 foot in height. These decorative bases below are available in either cast aluminum or cast iron and are assembled around the base of the SiteLink shaft during installation.

Cast Aluminum Clamshell Bases									
Series / Size	Diameter	Height	ST1	ST2	ST3	SL4	SL5	SL6	SL8
Atlanta (AT22CSB)	22"	36.38"		8'-30'				8'-30'	
Columbia (C24CSB)	24"	24.25"		8'-30'				8'-30'	
Columbia (C26CSB)	26"	28.25"		8'-30'	8'-30'			8'-30'	8'-30'
Columbia (C28CSB)	28"	31.63"		8'-30'	8'-30'			8'-30'	8'-30'
North Yorkshire (NY24CSB)	24"	42"		8'-30'				8'-30'	
Rope (SLCBRP)	11"	42"		8'-30'					
Smooth (SLCBSM)	8.13"	36"		8'-30'					
	8.13"	42"		8'-30'					
	8.13"	48"		8'-30'					
	11.9"	36"			8'-30'				
	11.9"	42"			8'-30'				
	11.9"	48"			8'-30'				

Cast Iron Clamshell Bases									
Series / Size	Diameter	Height	ST1	ST2	ST3	SL4	SL5	SL6	SL8
Columbia (C24CSB)	24"	24.25"		8'-30'				8'-30'	
Columbia (C26CSB)	26"	28.25"		8'-30'	8'-30'			8'-30'	8'-30'
Columbia (C28CSB)	28"	31.63"			8'-30'				8'-30'
North Yorkshire (NY24CSB)	24"	42"		8'-30'	8'-30'			8'-30'	8'-30'
North Yorkshire (NY28CSB)	28"	42"			8'-30'				8'-30'

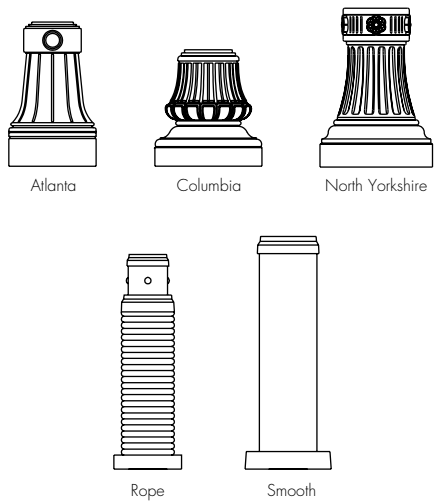

Two-piece clamshell bases



Shaft Specifications

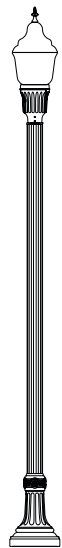

SL4

- + 4.5" Extruded aluminum, fluted shaft
- + Available with a variety of single-piece aluminum base styles
- + Integral base, one-piece durable construction
- + Available up to 16' height

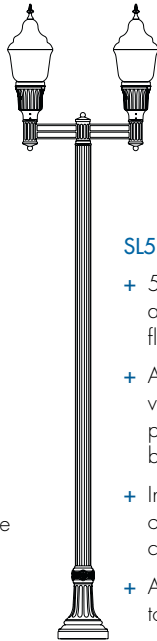

SL5

- + 5.25" Extruded aluminum, fluted shaft
- + Available with a variety of single-piece aluminum base styles
- + Integral base, one-piece durable construction
- + Available up to 22' height

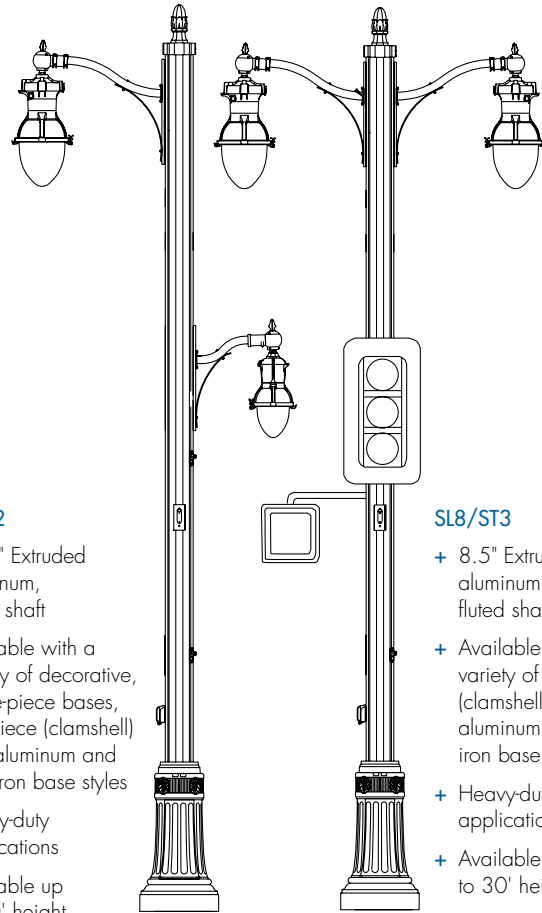

SL6/ST2

- + 5.75" Extruded aluminum, fluted shaft
- + Available with a variety of decorative, single-piece bases, two-piece (clamshell) cast aluminum and cast iron base styles
- + Heavy-duty applications
- + Available up to 30' height

SL8/ST3

- + 8.5" Extruded aluminum, fluted shaft
- + Available with a variety of two-piece (clamshell) cast aluminum and cast iron base styles
- + Heavy-duty applications
- + Available up to 30' height

*ST1 is a light duty pole typically used for signage

Description: The aluminum extruded pole shaft shall be configured in a TracLoc orientation, utilizing a patented four-sided dovetail track system. The exterior of the TracLoc profile is constructed for modular accessory attachments which can be moved or changed after initial installation. The interior of the TracLoc profile allows for five independent and separate wiring raceways for initial assembly and post installation wiring flexibility.

Design: The pole shall conform to the requirements of the "Standard Specifications for Structural Supports for Highway Signs, Luminaires and Traffic Signals, 2013 edition" by The American Association of State Highway and Transportation Officials for a basic wind speed as specified supporting luminaires and other accessories as specified by the customer.

Submittals: Shop drawings clearly delineating the pole assembly and design criteria shall be provided. Substantiating structural calculations shall also be provided if specified by the customer.

Materials: The shaft shall be constructed of extruded tube of 6061-T6 aluminum, all SLA series excluding SL5, in accordance with the requirements of ASTM B221-02. The pole shall be of sufficient nominal thickness to meet the design requirements without use of internal reinforcing sleeve. No longitudinal shaft welds shall be allowed.

Base: The base shall be either a one-piece cast structural base or a two-piece clamshell base of aluminum alloy 356 per ASTM B26 or B108. The structural base shall be joined to the shaft by means of a complete circumferential weld. There shall be a cast aluminum access door fastened with tamper resistant screws. The base shall have provisions for grounding by the use of a lug accessible through the access door.

Welding: Welding shall be done by the inert gas shielded metal arc method with consumable electrode. Aluminum alloy 4043 electrode shall be used. Welding shall be in accordance the American Welding Society AWS Specification D1.2, Structural Welding Code - Aluminum.

Anchorage: Four steel anchor bolts shall be supplied with each lighting pole. The bolt size and length shall be in accordance the AASHTO Specification for the loads imposed by the poles. The anchor bolt material shall meet the requirements of ASTM F1554 Grade 55. Bolts shall be hot dipped galvanized per ASTM A153 at the threaded end for at least 10 inches. Optionally, full length galvanized bolts will be provided if specified by the customer. For each bolt a heavy hex nut per ASTM A563 grade DH or 2H and washer shall be supplied. The nut and washer shall be fully galvanized per ASTM A153 or ASTM B695.

Miscellaneous Hardware: All nuts, bolts, and washers used in the assembly of the pole shall be AISI type 300 series stainless steel per ASTM A193 Class 1 Grade B8 except for anchorage hardware.

Finish: Surface Preparation - Pole shafts and bases shall be prepared for powder coating through a 5-stage cleaning process.

Powder Coating: Powder coating material shall be a thermosetting Polyester Powder Coating. A minimum coating thickness of 1 1/2 mils shall be maintained. Application of powder shall be electrostatically applied by a closed loop powder coating system featuring automatic spray guns with computerized controls to assure thickness conformance. Premium paint and anodized finishes are available.

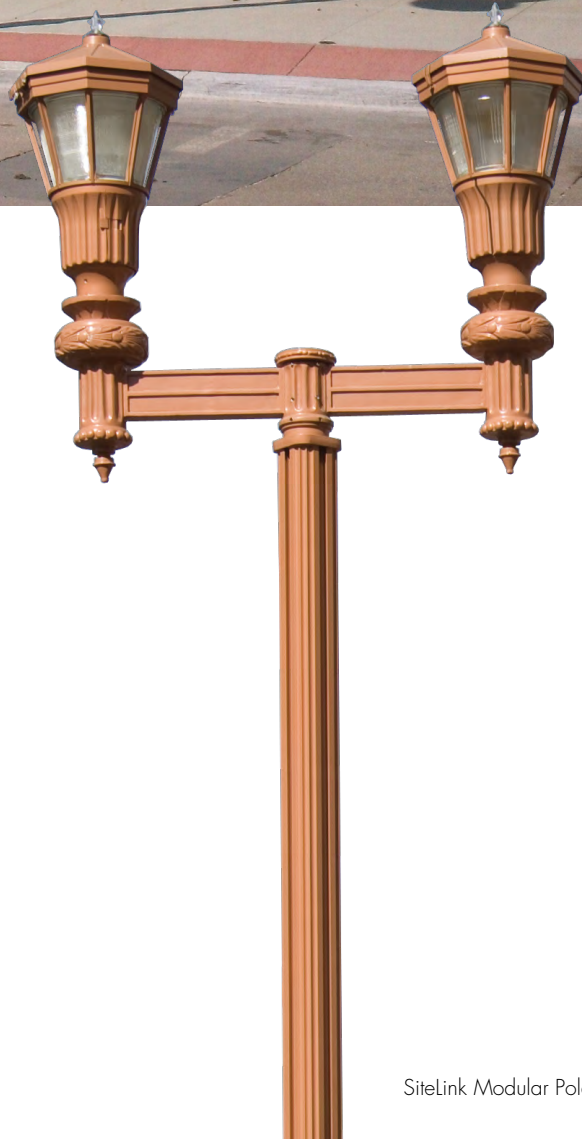

Luminaire Arms

SiteLink has a variety of mounting arms available for post-top and horizontal mounting in roadway and area lighting applications.

Post-top and Pendant Arms

The structural design of SiteLink can take on either a historical or modern style based on the variety of decorative bases or clamshell bases available. To help complete the style for applications that require arms, you can choose from the entire Holophane portfolio of decorative arms. You can learn more about all Holophane decorative arms in the **Holophane Poles & Arms Guide**.



SiteLink Arms

While virtually all arms from Holophane can be configured for SiteLink poles, we have designed several arms specifically for the SiteLink platform to capitalize on the unique traits and benefits of the TracPole system. These arms, for pendant applications, are only for use with SiteLink poles.

Aspen Grove (SLAG)

Mission Cross (SLMC)

New York (SLNY)

Stanley Park (SLSP)

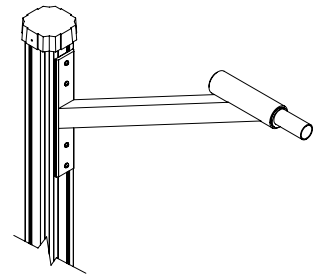
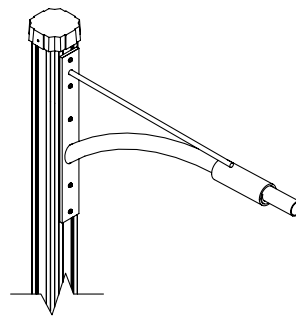
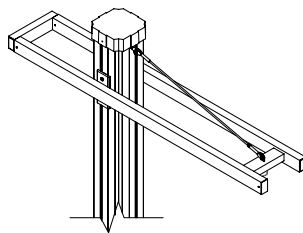
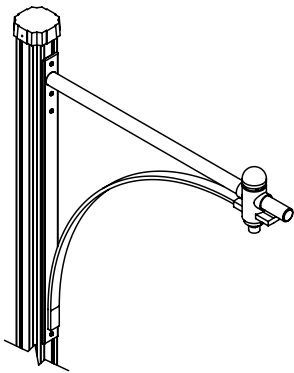

Arm Specifications

Construction: All welding on the decorative luminaire arm shall be per ANSI/AWS D1.2-90. All welders shall be certified per ANSI/AWS D1.2-90 Section 5.

Installation: The arms shall attach to the side of the pole with (2) or more Tracnuts. Arms shall have either a Quick-Lock Stem Mount (QSM) or a 1.5" male NPT fitting for luminaire mounting. stainless steel.

Materials: The post mounting piece and luminaire mounting piece shall be either heavy wall, cast aluminum, produced from certified ASTM 356.1 ingot per ASTM B179-95a or ASTM B26-95, or extruded aluminum produced with ASTM 6063 or 6061 alloy. The arm shall be aluminum, ASTM 6063 or 6061 alloy. All hardware shall be stainless steel.





Banner Arms and Accessories

Sitelink offers a standard set of functional cast aluminum banner arms and other accessories for use with the TracLoc system.

Banners can be moved to accommodate new banner sizes, removed for different pole requirements or inclement weather, or added for special events easily without damaging the surface of the pole.

Sitelink is compatible with just about any traditional pole accessory and lighting fixture. It is also adaptable so that communication systems, traffic control, security devices and street amenities may be mounted to the versatile tracloc system. This is accomplished through a variety of mounting hardware.



Accessory Specifications

Auxiliary Channel Exit	Series
Includes casting, cord grip and mounting template. (Not available with ST1)	SLAUX
Banner Bolt on Arms	Series
12" to 36" banner arm with finial and optional scroll and eyebolt	BA
Planters Banner Bolt on Arms	Series
18" to 24" planter banner in length and finial and scroll option	PBA
11" Old Santa Fe planter arm with decorative scroll	OSPA
Flagpole Holders (Single Stationary)	Series
Flag holder for 0.750" O.D. flagpole	FPH
Flag holder for 1.00" O.D. flagpole	
Flag holder for 1.25" O.D. flagpole	
Eyebolt Plates	Series
3/8" SS eyebolt, plate, and TracNut kit	EB
GFCI Outlets, 120 volt, 20 amp	Series
Receptacle with wet location while cover closed	FG
Receptacle with small, in-use wet location ccover	FGIUS
Receptacle with large, in-use wet location ccover	FGIUL
Sign Holder	Series
Mounting bracket and hardware for 6" street sign	SLSIGN
Mounting bracket and hardware for 9" street sign	
Signal Hub	Series
1.50" NPS threaded hub and mounting plate for traffic and pedestrian signals (two required per signal)	SLSIGNALHUB
TracNut Kits	Series
Sitelink - Large TracNut for ST1, ST2, ST3, SL6 and SL8 3/8IN x .075IN bolt and lockwasher. Use with .06IN - .188IN thick mounting plate.	TNUT3/8-075LG
Sitelink - Large TracNut for ST1, ST2, ST3, SL6 and SL8 3/8IN x 1.00IN bolt and lockwasher. Use with .275IN - .430IN thick mounting plate.	TNUT3/8-100LG
1 SiteLink - Small TracNut for SL4 and SL5 3/8IN x 1.00IN bolt and lockwasher. Use with .188IN - .250IN thick mounting plate.	TNUT3/8-100SM
Sitelink - Large TracNut for ST1, ST2, ST3, SL6 and SL8 3/8IN x 1.25IN bolt and lockwasher. Use with .525IN - .650IN thick mounting plate.	TNUT3/8-125LG
Sitelink - Small TracNut for SL4 and SL5 3/8IN x 1.25IN bolt and lockwasher. Use with .385IN - .500IN thick mounting plate.	TNUT3/8-125SM
Sitelink - Large TracNut for ST1, ST2, ST3, SL6 and SL8 3/8IN x 1.25IN bolt and lockwasher. Use with .500IN thick mounting plate.	TNUT3/8-125WLG
Sitelink - Large TracNut for ST1, ST2, ST3, SL6 and SL8 3/8IN x 1.50IN bolt and lockwasher. Use with .775IN - .900IN thick mounting plate.	TNUT3/8-150LG
Sitelink - Large TracNut for ST1, ST2, ST3, SL6 and SL8 3/8IN x 1.50IN bolt and lockwasher. Use with .75IN thick mounting plate.	TNUT3/8-150WLG



Auxiliary Channel Exit



Banner & Planter Arms



Flagpole Holders



Eyebolt



GFCI Outlet Box



Sign Holder



Signal Hub

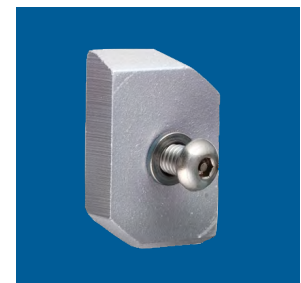

Trac Nut Kits



Signage & Wayfinding

The SiteLink platform is an ideal solution for simplified mounting solutions of a variety of signage needs.

You'll find that the flexibility of SiteLink is demonstrated well in its use for anything from street and traffic signs to several different location and wayfinding applications. Choose from many Holophane sign mounting options based on your supplied sign or provide your own 3rd party sign mount to meet your specific needs.





Customs

The versatility of the SiteLink platform permits provisions for a wide range of customization and third-party products including luminaires, speakers, cameras, network devices and many more.

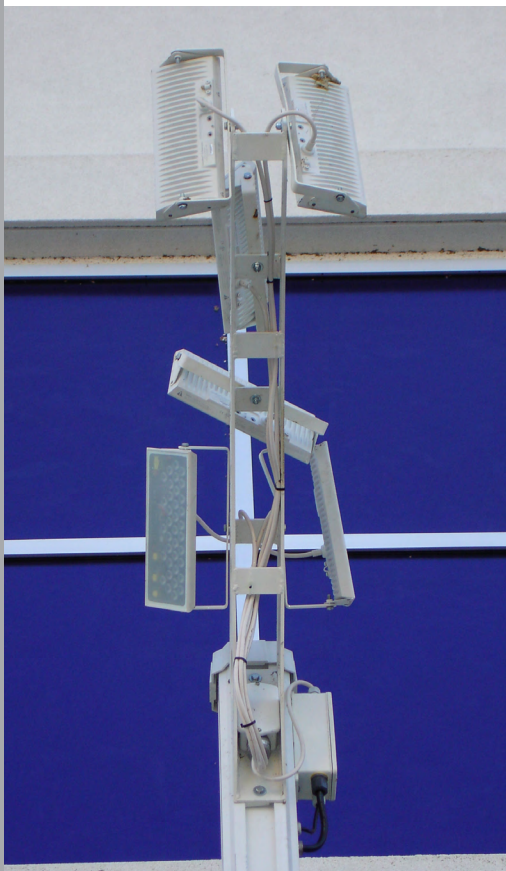
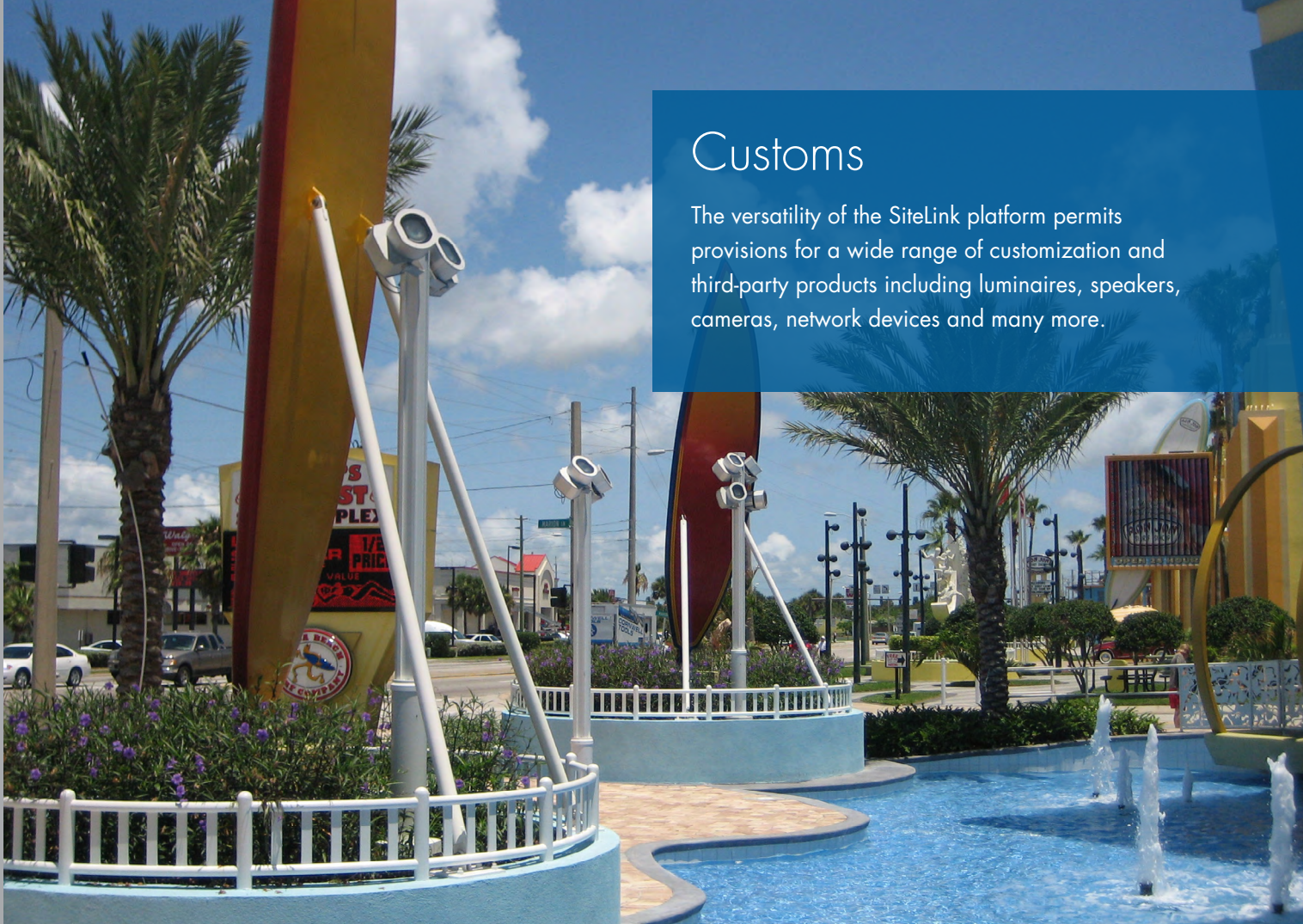



Simplified solutions for pole-mounted EV charging

Enhancing your sustainability efforts

Rising concerns for the environment and providing the necessary infrastructure for sustainable energy and transportation efforts has made the unique features of Sitelink even more important today. With the passing of the Infrastructure Bill and the growing demand for EV charging stations, Holophane has worked with key customers to develop an installer-friendly Sitelink mounting solution for pole-mounted electric vehicle charging.

Flexible provisions for EV charger cabling

Holophane engineers have designed a new provision and mounting solution for cables up to 2.5" in diameter. The design of the provision maintains the original designed strength of the Sitelink shaft and prevents damage to the insulation on the cable.

The shafts ship with the gasketed cover plates and are then replaced with the gasketed threaded stud covers plates when Meter and EV Charger (not included) are installed. A sealing washer securely holds the device to the mounting plate and prevents water infiltration.

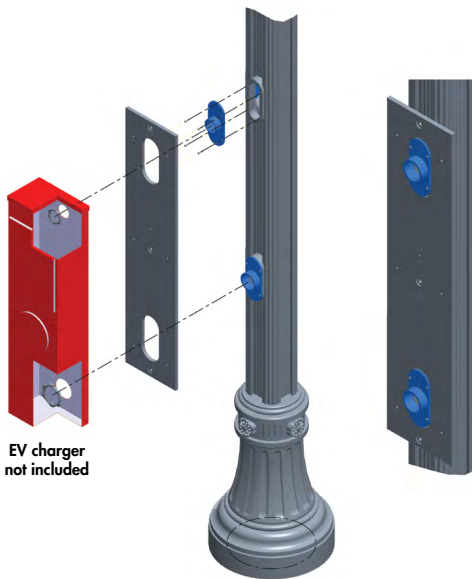

EV charger not included

Customizing to your needs

You can explore a plethora of customization options on Sitelink poles and bollards of various heights. The one variable will be the Meter and EV Charger mounting requirements since there is currently no industry standard. Therefore, to ensure a proper fit, the mounting dimensions, EPA and weight will be required to ensure the mounting plate is correctly designed.

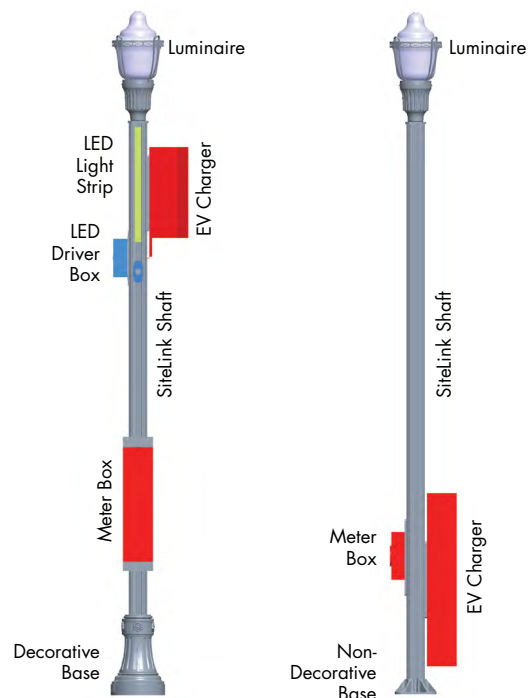

Applications and Inspiration







sitelink[®]
by **HOLOPHANE**

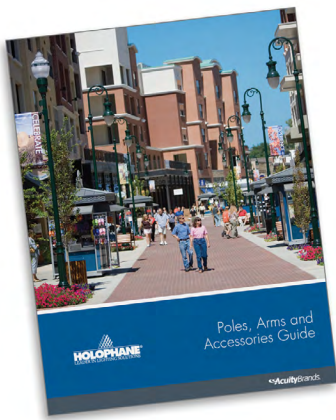

Get more info on Holophane Poles, Arms and Accessories!

For more information on other Holophane poles, or to explore the wide variety of arms and accessories you can use with Sitelink, you can download our Holophane Pole, Arms and Accessories guide in the Resources section of the holophane.com web site.



HOLOPHANE[®]
LEADER IN LIGHTING SOLUTIONS

Acuity Brands Lighting, Inc.

Holophane Headquarters,
One Lithonia Way, Conyers GA 30012

Contact your local Holophane factory sales representative for application assistance, and computer-aided design and cost studies.

Warranty Five-year limited warranty. Full warranty terms located at www.acuitybrands.com/CustomerResources/Terms_and_conditions.aspx

Visit our web site at
www.holophane.com