



Catalog Number
Notes
Type

Contractor Select™

JSBT

Juno 6" SlimBasics™ JSBT Tapered Switchable White LED Surface Mount Disk Light with Motion Sensing

The SlimBasics JSBT Switchable White Tapered LED Disk Light with an integrated motion sensing provides added convenience by automatically activating the light when an occupant enters the space. Available in a 6" size, the JSBT mounts directly over standard junction boxes allowing the fixture to be installed below the ceiling. The result is a budget friendly and simple installation. The ultimate adaptability for your space is achieved through the ability to choose between three different color temperatures (3000K/4000K/5000K). The passive infrared (PIR) sensor provides automatic activation when someone enters the room and is factory set to automatically turn off after 40 seconds of no motion. Don't need motion sensing throughout the entire space? No problem! A consistent aesthetic across the entire JSBT family allows you to mix and match versions without disrupting the continuity of the space.

FEATURES:

- This convenient solution combines both 3CCT switchable white technology and an integrated motion sensor
- Perfect for use in closets, pantries, residential garages, and laundry rooms in both single and multi-family homes, as well as in light commercial spaces such as self-storage facilities
- Suitable for use in closets, compliant when installed to NFPA® 70 NEC® Section 410.16 (A)(1) and (C)(1)
- Installs directly into industry standard junction boxes

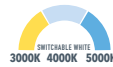







Note: Image shown is back of fixture with CCT selector



Catalog Number	UPC	Description	Lumens	Input Watts	CCT	CRI	Voltage	Finish	Pallet qty.
JSBT 6IN SWW2 90CRI PIR MW M6	00196182201639	6" LED Disk Light With Sensor	1050L	15.3W	3000K/4000K/5000K	90	120V	White	480

ACCESSORIES	
JSBTADPTR 4IN CNDA M50	Canadian 4" JBOX Adapter

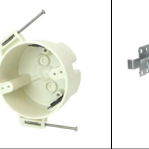

JBOX Compatibility

	3-1/2" Octagon Box Steel	4" Drawn Octagon 1-1/2" Deep Steel	3-1/2" Drawn Round Ceiling Pan Steel / Old Work	4" Round Plastic / New York	4" Drawn Round Ceiling Pan Steel	4" Round Plastic / New Work	4" Dia. Ceiling Box With Bar Plastic / New York
							
Exterior LXWXH	3.2" x 3.2" x 1.55"	3.54" x 3.54" x 1.55"	3.38" Rd. x 0.5" Dep.	4" Dia. x 2.3"	4" Dia. x 0.5" Dep.	4" Dia. x 2.375"	14.5" x 4.5" x 4"
Mounting Dimension	2.75"	3.5"	2.75"	2.75" / 3.5"	3.5"	2.75" / 3.5"	2.75" / 3.5"
Fixture	JSBT 6IN	JSBT 6IN	JSBT 6IN	JSBT 6IN	JSBT 6IN	JSBT 6IN	JSBT 6IN

	4" Square Box	WiringPro 4" Square Box	Iberville 4" Octagonal Box
			
Exterior LXWXH	4" x 4" x 1.5"	4" X 4" X 1.5"	4" x 4" x 1.5"
Mounting Dimension	4"	4"	4"
Fixture	JSBT 4IN	JSBT 4IN	JSBT 4IN

Canadian 4IN J-Box Bracket

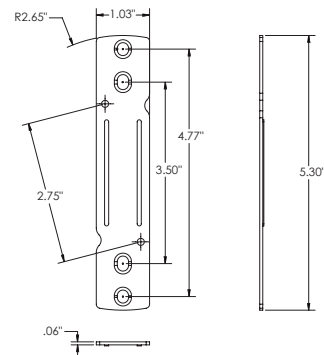

Sensor Coverage Pattern

SIDE VIEW

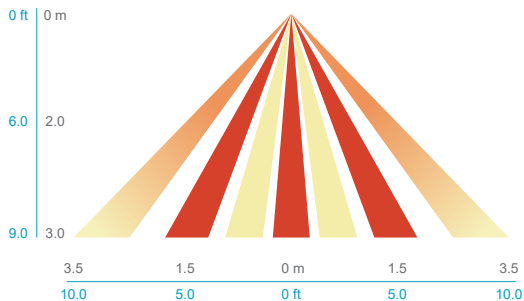

TOP VIEW

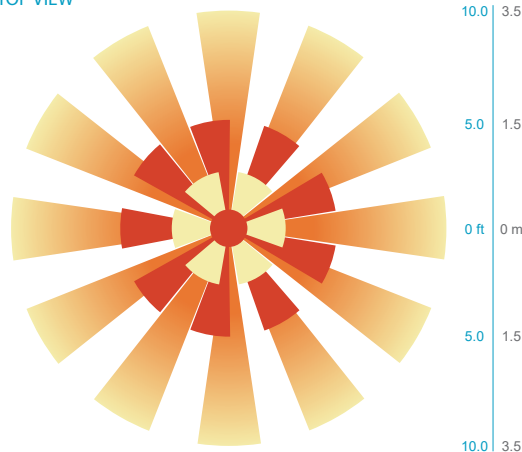



Specifications

LED LIGHT ENGINE:

LED board mounted directly to the aluminum housing designed to provide superior thermal management and ensure long life • Integrated PIR on/off sensor with a 40 second time delay factory preset (can not be field adjusted) • Switchable white LED color temperature technology offers 3000K, 4000K, 5000K all in one disk light • 90 CRI minimum • Accommodates 120 volts AC at 60Hz • Non-dimming.

CONSTRUCTION:

Low profile tapered aluminum trim frame with matte white finish • Molded polycarbonate, UV stabilized diffuser dome lens conceals the LEDs from direct view and provides uniform lens luminance.

ELECTRICAL CONNECTIONS:

Fixture provided with leads for direct wire connection in JBox.

JUNCTION BOX MOUNTING:

The driverless JSBT installs directly into industry standard junction boxes that requires no separate mounting bracket for installation • Compatible boxes include 3-1/2" and 4" octagon junction boxes (1-1/2" minimum depth), round mud rings with 2-3/4" mounting centers, and 3" & 4" diameter non-metallic boxes • Provides fast installation of fully assembled fixture to JBox • Suitable for ceiling mount • Suitable for use in closets, compliant when installed to NFPA® 70 NEC® Section 410.16 (A)(1) and (C)(1).

LIFE:

High performance, long functional life of 50,000 hrs (L70).

LISTINGS:

ETL listed for US and Canada • ENERGY STAR® certified product • Suitable for indoor damp location.

WARRANTY:

5-year limited warranty. This is the only warranty provided and no other statements in this specification sheet create any warranty of any kind. All other express and implied warranties are disclaimed. Complete warranty terms located at: www.acuitybrands.com/support/warranty/terms-and-conditions

Note: All reports are based on published industry procedures; actual performance may differ as a result of the end-user environment and applications.

All values are design or typical values, measured under laboratory conditions at 25 °C. Specifications subject to change without notice.

Dimensions

	Width	Depth	Lens Opening
JSBT 6IN PIR	8.39	1.34	5.35

All dimensions are in inches

