

General Illumination Round Wallwash

4"

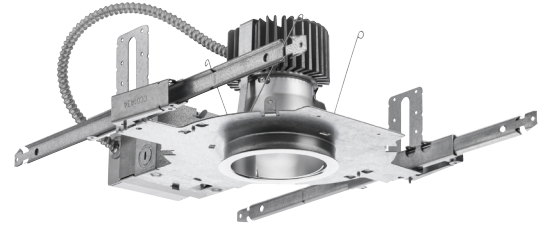

OVERVIEW

Feature Set

- Tunable White solution that reproduces natural light patterns and colors, complements materials, and supports productivity.
- Wallwash enables uniformity from floor to ceiling. Smooth, balanced illumination optimized for ceilings of 8' to 12' with recommended spacing of 3' from wall and 3' centers.
- Rhythm Range (2700K-6500K) follows the cycle of daylight
- Productivity Range (3000K-5000K) to re-energize and inspire, ideal for collaboration
- WARMDIM® Range (3000K-1800K) for relaxing; warm and comfortable when dimmed
- Bounding Ray™ Optical Principle design provides 45° cut-off to source and source image
- Rated 65,000 hours (L80) at 25°C ambient temperature
- Dim to Dark 100% - 0.1%

Distribution



Superior Performance

Nominal lumens	750	1000	1500	2000	2500	3000
Delivered	687	827	1150	1531	1975	2352
Wattage	9	10	14	19	24	29
Efficacy	75	80	82	82	82	80

*80 CRI, 3500K

COMPLIMENTARY PRODUCTS

Coordinated Apertures | Multiple Layers of Light



General Illumination Layer | EVO



High Center Beam Layer | Incito



EVO + Incito — Multiple Layers of Light

Core



Healthcare



Special Applications



A+ Capable options indicated by this color background.

Luminaire Type:

Catalog Number:

EXAMPLE: EVO4WW TUWH PROR/07 PRFL LSS MVOLT NLT

Series	Dynamic Feature	Dynamic Range ¹	Nominal lumens values ²	Reflector/Flange Color	Trim Style
EVO4WW 4" Round Wallwash	TUWH Tunable White	PROR Productivity Range (3000K-5000K)	/07 750 lumens /10 1000 lumens	AR Clear PR Pewter	WR³ White painted BR³ Black painted
EVO4CWW 4" Corner Wallwash	WDIM Warm Dimming	RHYR Rhythm Range (2700K-6500K)	/15 1500 lumens /20 2000 lumens	WTR Wheat GR Gold	WRAMF³ White painted antimicrobial finish
EVO4DWW 4" Double Wallwash		HALR Halogen Range (3000K-1800K)	/25 2500 lumens /30 3000 lumens		FL Flangeless

Aperture Finish	Voltage	Control Interface Type	Options
LSS Semi-specular	MVOLT	NLT⁴ nLight nTune interface	SF Single fuse
LD Matte-diffuse	120 120V	NLTER⁴ nLight nTune interface with emergency circuit	TRW⁵ White painted flange
LS Specular	277 277V	ZT 0-10V dimming	TRBL⁶ Black painted flange
		DALI DALI logarithmic dimming to <1%.	90CRI High CRI (90+)
			E10WCP⁷ Emergency battery pack, 10W Constant Power, CA Title 20 compliant with integral test switch
			E10WCPR⁷ Emergency battery pack, 10W Constant Power, CA Title 20 compliant with remote test switch
			CP⁸ Chicago Plenum
			BGTD Bodine Generator Transfer Device

ACCESSORIES — order as separate catalog numbers (shipped separately)

SCA4	Sloped ceiling adapter. Degree of slope must be specified (5D, 10D, 15D, 20D, 25D, 30D). Ex: SCA4 10D. Refer to TECH-190 .
CTA4-8 YK	Ceiling thickness adapter (extends mounting frame to accommodate ceiling thickness up to 5"). Adds 1" to fixture height.
FCS 7TSN XXX	Fresco Lighting Control with DMX and ethernet; XXX = Color. Refer to FRESCO spec sheet for additional options.
nPODM 2P DX CCT XX	nLight 2 Channels, On/off + raise/lower control, CCT, XX = Color. Refer to nLight .
nPODM 4S DX XX	nLight 4 Scene Control, On/off + raise/lower control, XX = Color. Refer to nLight .
nPODM 4S XX	nLight 4 Scene Control, XX = Color. Refer to nLight .

ORDERING NOTES

- PROR and RHYR available only with TUWH. HALR available only with WDIM.
- Nominal lumen values when tested at 3500K.
- Not available with aperture finishes.
- Requires power from nLight network bridge or nPS 80.
- For use with different reflector finish only (i.e. AR, PR, WTR, GR options). Not applicable with WR (white reflector) or FL (flangeless) option.
- For use with different reflector finish only (i.e. AR, PR, WTR, GR options). Not applicable with BR (black reflector) or FL (flangeless) option.
- Above ceiling access required for use with battery pack options.
- Voltage-specific (120 or 277V). Not available with battery pack option.

Optical Assembly

Fully serviceable and upgradeable lensed LED light engine suitable for field maintenance or service from below the ceiling. Optical design is a Bounding Ray™ design with 45° cutoff to source and source image. Top-down flash characteristic for superior glare control. Unitized optics shall have mechanical attachment of the light engine to the lower reflector for complete optical alignment.

Electrical

The luminaire shall operate from a 50 or 60 Hz ±3 Hz AC line over a voltage ranging from 120 VAC to 277 VAC. The fluctuations of line voltage shall have no visible effect on the luminous output. The luminaire shall have a power factor of 90% or greater at all standard operating voltages and full luminaire output. Sound Rated A+. Driver shall be >80% efficient at full load across all input voltages. Input wires shall be 18AWG, 300V minimum, solid copper.

Controls

Tunable white nTune™ is an all-digital light color temperature control within an nLight enabled luminaire. nTune™ allows color temperature settings through the Productivity Range of 3000K to 5000K or Rhythm Range of 2700K to 6500K. Refer to nLight Programming User's Guide for instructions on customizing your application with SensorView™.

Dimming

The luminaire shall be capable of continuous dimming without perceivable stroboscopic flicker as measured by flicker index (ANSI/IES RP-16-10) over a range of 100 – 0.1% of rated lumen output with a smooth shut off function to step to 0%.

Construction

Luminaire housing shall be constructed of 16-gauge galvanized steel and have preinstalled telescopic mounting bars with maximum 32" and minimum 15" extension and 4" vertical adjustment. Luminaires shall be suitable for installation in ceilings up to 1½" thick. (specify ceiling thickness adapter to extend frame to accommodate ceiling thickness up to 5"). Tool-less adjustments shall be possible after installation. The assembly and manufacturing process for the luminaire shall be designed to assure all internal components are adequately supported to withstand mechanical shock and vibration. 25°C ambient temperature standard (1/2" clearance on all sides from non-combustible materials in non-IC applications, unless marked spacing noted otherwise). For use in insulated ceilings, a 3" clearance on all sides from insulation is required (unless marked spacing noted otherwise).

Listings

Fixtures are CSA certified to meet US and Canadian Standards: All fixtures manufactured in strict accordance with the appropriate and current requirements of the "Standards for Safety" to UL, wet location covered ceiling.

Photometrics

LEDs tested to LM-80 standards. Measured by IESNA Standard LM-79-08 in an accredited lab. Lumen output shall not decrease by more than 20% over the minimum operational life of 60,000 hours.

Buy American Act

This product is assembled in the USA and meets the Buy America(n) government procurement requirements under FAR, DFARS and DOT regulations. Please refer to www.acuitybrands.com/buy-american for additional information.

Warranty

5-year limited warranty. Complete warranty terms located at: www.acuitybrands.com/support/customer-support/terms-and-conditions

Note:

Actual performance may differ as a result of end user environment and application. All values are design or typical values, measured under laboratory conditions at 25 °C.

A+ Capable Luminaire

This item is an A+ capable luminaire, which has been designed and tested to provide consistent color appearance and out-of-the-box control compatibility with simple commissioning.

- All configurations of this luminaire meet the Acuity Brands' specification for chromatic consistency
- This luminaire is part of an A+ Certified solution for nLight® control networks when ordered with drivers marked by a shaded background*
- This luminaire is part of an A+ Certified solution for nLight® control networks, providing advanced control functionality at the luminaire level, when selection includes driver and control options marked by a shaded background*

To learn more about A+, visit www.acuitybrands.com/aplus.

*See ordering tree for details

Tables of Use

CCT/CRI Multiplier Table		
CRI	CCT	Multiplier
80	2700K	0.96
	3000K	0.97
	3500K	1.00
	4000K	1.01
	5000K	1.07
90	2700K	0.80
	3000K	0.83
	3500K	0.85
	4000K	0.87
	5000K	0.91

Lumen Output Multiplier - Finish Trim						
Finish	Clear (AR)	Pewter (PR)	Wheat (WTR)	Gold (GR)	White (WR/WRAMF)	Black (BR)
Specular (LS)	1.00	0.88	0.83	0.95	N/A	N/A
Semi-specular (LSS)	0.95	0.84	0.79	0.90	N/A	N/A
Matte-diffuse (LD)	0.85	0.73	0.69	0.80	N/A	N/A
Paint	N/A	N/A	N/A	N/A	0.87	0.73

Driver Default Dimming Curve			
Nomenclature	Min Dimming	Driver Dim Curve	Control Dim Curve
ZT	0.1%	Linear	Linear/Logarithmic
DALI	0.1%	Linear	Linear/Logarithmic

MAINSTREAM DYNAMIC TUNABLE WHITE WITH NTUNE TECHNOLOGY

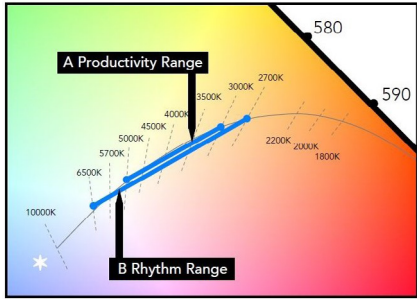

Tunable white nTune™ is an all digital light color temperature control within an nLight enabled luminaire. This brings tunable white lighting control into the mainstream with repeatable, consistent results in an economical luminaire form and system already familiar to schools. Designers and facility operators are granted the freedom to tie scenes to specific activities or to complement colors or materials within a visual environment. nTune™ allows color temperature settings through the Productivity Range of 3000K to 5000K or Rhythm Range of 2700K to 6500K. Refer to nLight Programming User's Guide for instructions on customizing to your application with SensorView™.

TUNABLE WHITE GPHD
Gamut: One dimensional warm-Cool
Path: Direct 3000K to 5000K (Productivity Range) or 2700K to 6500K (Rhythm Range)
Handle: Two Natural Language Handles: Intensity and CCT
Data: nLight with nTune technology for both handles of control

- A** Productivity Range 3000K to 5000K
- B** Rhythm Range 2700K to 6500K

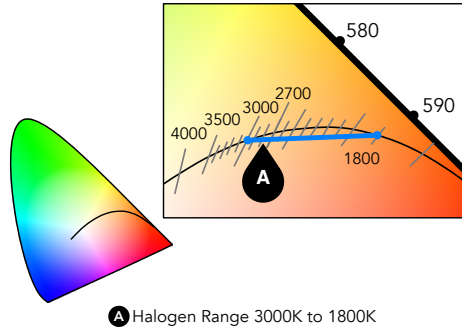

A Halogen Range 3000K to 1800K

How to Estimate Delivered Lumens in Emergency Mode
<p>Delivered Lumens = 1.25 x P x LPW</p> <p>P = Output power of emergency driver. P = 10W for PS1055CP</p> <p>LPW = Lumen per watt rating of the luminaire. This information is available on the ABL luminaire spec sheet.</p>

DIMENSIONAL DATA

*Dimensions in inches [centimeters]

Aperture: 4-5/16" (11)	Ceiling Opening: 5-1/8" (13) self-flanged
Overlap trim: 5-7/16" (13.8)	5-1/4" (13.3) flangeless

Standard

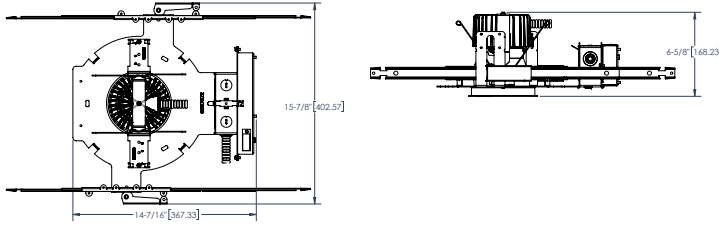

Battery Pack

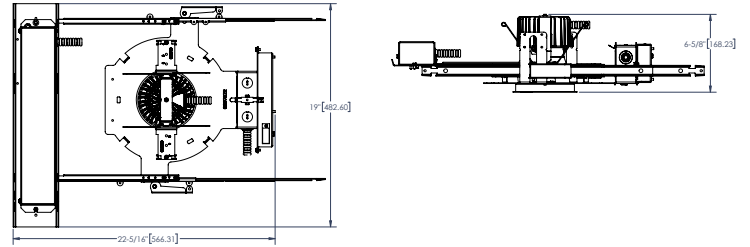

Double Wallwash

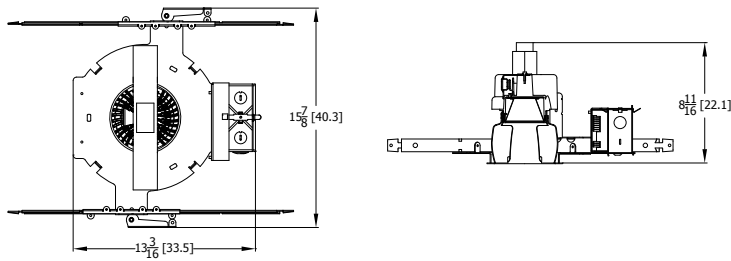

Corner Wallwash

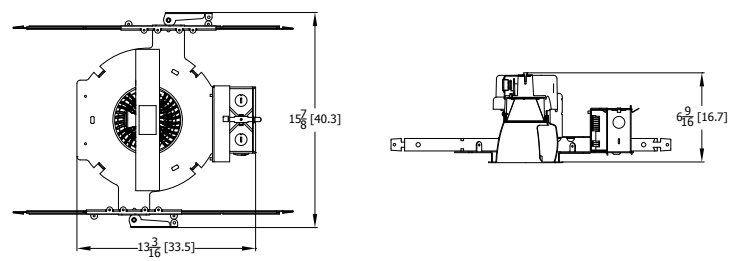

CP Standard

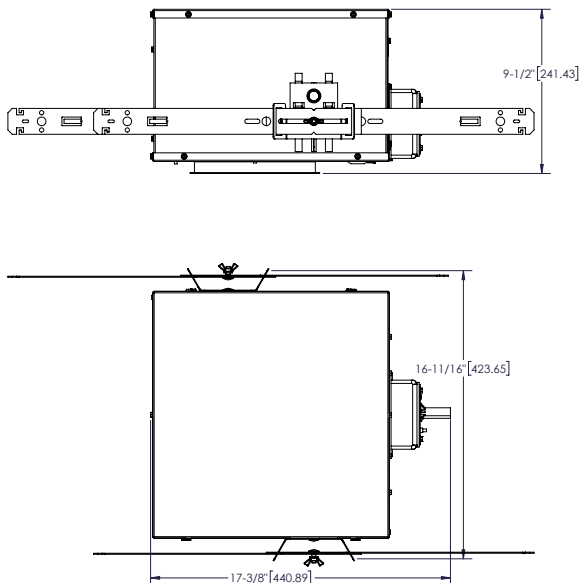

Photometry

EVO4WW TUWH RHYR /30 4AR LS CRI80 2700K

INPUT WATTS: 29.5, DELIVERED LUMENS: 2536, LM/W=85.9 , WALLWASH, TEST NO. 19-102-B01P61

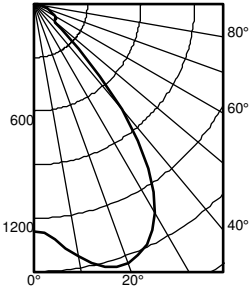

Ave Lumens	Zone Lumens % Lamp	pf pc pw	80%			20% 70%			50%					
			50%	30%	10%	50%	30%	10%	50%	30%	10%			
0	1270	0° - 30°	1239.3	48.9	0	119	119	119	116	116	116	111	111	111
5	1323	0° - 40°	1920.6	75.7	1	108	105	102	106	103	100	102	99	97
15	1527	0° - 60°	2348.6	92.6	2	98	93	89	96	92	88	93	89	86
25	1489	0° - 90°	2536.1	100.0	3	89	83	78	88	82	77	85	80	76
35	1121	90° - 180°	0.0	0.0	4	82	75	69	80	74	69	78	73	68
45	352	0° - 180°	2536.1	*100.0	5	75	68	62	74	67	62	72	66	61
55	147		*Efficiency		6	69	62	56	68	61	56	66	60	56
65	109				7	64	56	51	63	56	51	62	55	51
75	62				8	59	52	47	58	52	47	57	51	47
85	10				9	55	48	43	54	48	43	53	47	43
90	1				10	51	44	40	51	44	40	50	44	40

Initial FC					
Mounting Height	Center Beam	Diameter	FC	Diameter	FC
8.0	42.0	7.6	21.0	11.0	4.2
10.0	22.6	10.4	11.3	15.0	2.3
12.0	14.1	13.1	7.0	19.0	1.4
14.0	9.6	15.9	4.8	22.9	1.0
16.0	7.0	18.6	3.5	26.9	0.7

EVO4WW TUWH RHYR /30 4AR LS CRI80 3500K

INPUT WATTS: 29.5, DELIVERED LUMENS: 2352, LM/W=98.3 , WALLWASH, TEST NO. 19-102-B01P63

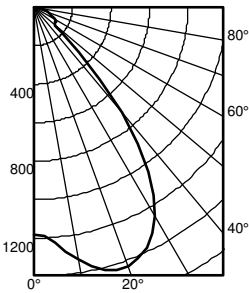

Ave Lumens	Zone Lumens % Lamp	pf pc pw	80%			20% 70%			50%					
			50%	30%	10%	50%	30%	10%	50%	30%	10%			
0	1178	0° - 30°	1149.5	48.9	0	119	119	119	116	116	116	111	111	111
5	1227	0° - 40°	1781.5	75.7	1	108	105	102	106	103	100	102	99	97
15	1416	0° - 60°	2178.4	92.6	2	98	93	89	96	92	88	93	89	86
25	1381	0° - 90°	2352.4	100.0	3	89	83	78	88	82	77	85	80	76
35	1040	90° - 180°	0.0	0.0	4	82	75	69	80	74	69	78	73	68
45	327	0° - 180°	2352.4	*100.0	5	75	68	62	74	67	62	72	66	61
55	137		*Efficiency		6	69	62	56	68	61	56	66	60	56
65	101				7	64	56	51	63	56	51	62	55	51
75	57				8	59	52	47	58	52	47	57	51	47
85	10				9	55	48	43	54	48	43	53	47	43
90	1				10	51	44	40	51	44	40	50	44	40

Initial FC					
Mounting Height	Center Beam	Diameter	FC	Diameter	FC
8.0	38.9	7.6	19.5	11.0	3.9
10.0	20.9	10.4	10.5	15.0	2.1
12.0	13.1	13.1	6.5	19.0	1.3
14.0	8.9	15.9	4.5	22.9	0.9
16.0	6.5	18.6	3.2	26.9	0.6

EVO4WW TUWH RHYR /30 4AR LS CRI80 6500K

INPUT WATTS: 29.5, DELIVERED LUMENS: 2620, LM/W=109.5 , WALLWASH, TEST NO. 19-102-B01P66

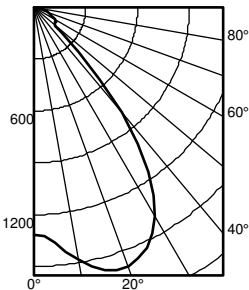

Ave Lumens	Zone Lumens % Lamp	pf pc pw	80%			20% 70%			50%					
			50%	30%	10%	50%	30%	10%	50%	30%	10%			
0	1312	0° - 30°	1280.4	48.9	0	119	119	119	116	116	116	111	111	111
5	1367	0° - 40°	1984.4	75.7	1	108	105	102	106	103	100	102	99	97
15	1578	0° - 60°	2426.5	92.6	2	98	93	89	96	92	88	93	89	86
25	1539	0° - 90°	2620.3	100.0	3	89	83	78	88	82	77	85	80	76
35	1158	90° - 180°	0.0	0.0	4	82	75	69	80	74	69	78	73	68
45	364	0° - 180°	2620.3	*100.0	5	75	68	62	74	67	62	72	66	61
55	152		*Efficiency		6	69	62	56	68	61	56	66	60	56
65	113				7	64	56	51	63	56	51	62	55	51
75	64				8	59	52	47	58	52	47	57	51	47
85	11				9	55	48	43	54	48	43	53	47	43
90	1				10	51	44	40	51	44	40	50	44	40

Initial FC					
Mounting Height	Center Beam	Diameter	FC	Diameter	FC
8.0	43.4	7.6	21.7	11.0	4.3
10.0	23.3	10.4	11.7	15.0	2.3
12.0	14.5	13.1	7.3	19.0	1.5
14.0	9.9	15.9	5.0	22.9	1.0
16.0	7.2	18.6	3.6	26.9	0.7

nLight® The nLight® solution is a digital networked lighting control system that provides both energy savings and increased user configurability by cost effectively integrating time-based, daylight-based, sensor-based and manual lighting control schemes.

Possibilities for nLight® wired

Fixtures ordered *without* the NLT option

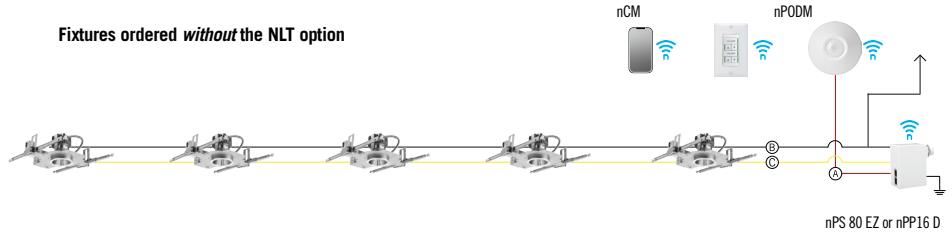

Fixtures ordered *with* the NLT option

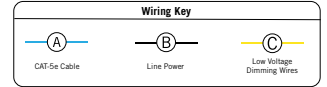
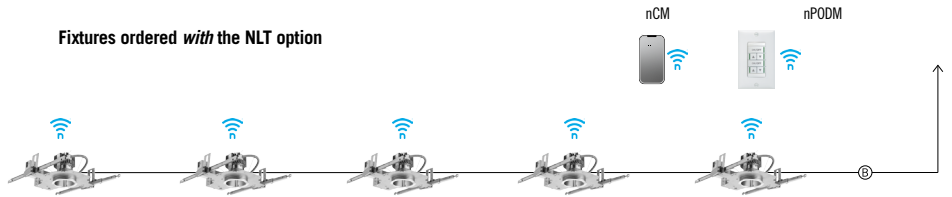

nLight® Wired Control Accessories

Order as separate catalog number. Visit [nLight](http://nLight.com).

Wall Switches

	Model Number
On/Off single pole	nPODM (color)
On/Off two pole	nPODM 2P (color)
On/Off & raise/lower single pole	nPOD DX (color)
On/Off & raise/lower two pole	nPODM 2P DX (color)
Graphic touchscreen	nPOD GFX (color)

Photocell Controls

Dimming	nCM ADCX
---------	----------

nLight® Wired Control Accessories (cont.)

Occupancy Sensors (PIR/dual tech)

	Model Number
Small motion 360°, ceiling	nCM 9 / nCM PDT 9
Large motion 360°, ceiling	nCM 10 / nCM PDT 10
Wide View	nWV 16 / nWV PDT 16
Wall switch with raise/lower	nWSX LV DX / nWSX PDT LV DX

Cat-5 Cables (plenum rated)

10', CAT5	CAT5 10FT J1
15', CAT5	CAT5 15FT J1