

OVERVIEW

General Illumination Lensed Wallwash with nTune

6"

Feature Set

- Tunable White solution that reproduces natural light patterns and colors, complements materials, and supports productivity.
- Wallwash enables uniformity from floor to ceiling. Smooth, balanced illumination optimized for ceilings of 8' to 12' with recommended spacing of 3' from wall and 3' centers.
- Rhythm Range (2700K-6500K) follows the cycle of daylight
- Productivity Range (3000K-5000K) to re-energize and inspire, ideal for collaboration
- WARMDIM® Range (3000K-1800K) for relaxing; warm and comfortable when dimmed
- Bounding Ray™ Optical Principle design provides 45° cut-off to source and source image
- Rated 65,000 hours (L80) at 25°C ambient temperature
- Dim to Dark 100% - 0.1%

Distribution

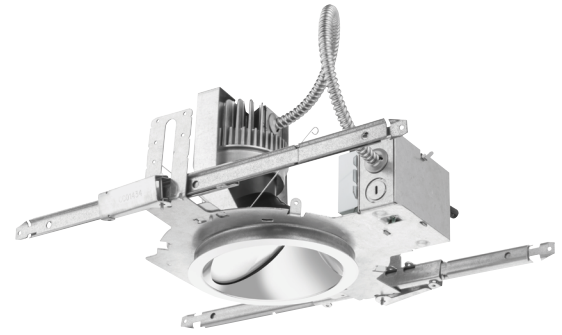

Superior Performance

Nominal lumens	750	1000	1500	2000	2500	3000	3500	4000	4500
Delivered	492	595	812	1109	1430	1703	2042	2342	2736
Wattage	9	11	14	19	24	29	35	40	48
Efficacy	55	57	58	59	60	60	59	58	57

*80 CRI, 3500K

COMPLEMENTARY PRODUCTS

Coordinated Apertures | Multiple Layers of Light



General Illumination Layer | EVO



High Center Beam Layer | Incito



EVO + Incito — Multiple Layers of Light

Core	Downlight	Adjustable	Open Wallwash	Lensed Wallwash	Cylinder	Pinhole	Bevel	Hyperbolic
Healthcare	MRI	Surgical Suite	Patient Room					
Special Applications	Dynamic	Food Service	Vandal/Tamper	Clean Room	Shower	Steam Room		

A+ Capable options indicated by this color background.

Luminaire Type:

Catalog Number:

EXAMPLE: EVO6LW TUWH PROR/10 AR LSS MVOLT NLT

Series	Dynamic Feature	Dynamic Range ¹	Nominal lumens values ²	Reflector/Flange Color	Trim Style
EVO6LW 6" Round Lensed Wallwash	TUWH Tunable White WDIM Warm Dimming	PROR Productivity Range (3000K-5000K) RHYR Rhythm Range (2700K-6500K) HALR Halogen Range (3000K-1800K)	/07 750 lumens	AR Clear PR Pewter WTR Wheat GR Gold WR³ White painted BR³ Black painted WRAMF³ White painted anti-microbial finish	(blank) Self-flanged FL Flangeless
			/10 1000 lumens		
			/15 1500 lumens		
			/20 2000 lumens		
			/25 2500 lumens		

Aperture Finish	Voltage	Control Interface Type	Options
LSS Semi-specular LD Matte-diffuse LS Specular	MVOLT 120 120V 277 277V	NLT⁴ nLight nTune interface NLTER⁴ nLight nTune interface with emergency circuit ZT 0-10V dimming DALI DALI logarithmic dimming to <1%.	SF Single fuse TRW⁵ White painted flange TRBL⁵ Black painted flange 90CRI High CRI (90+) E10WCP Emergency battery pack, 10W Constant Power, CA Title 20 compliant with integral test switch E10WCPR Emergency battery pack, 10W Constant Power, CA Title 20 compliant with remote test switch CP⁷ Chicago Plenum BGTD Bodine Generator Transfer Device

ACCESSORIES — order as separate catalog numbers (shipped separately)

CTA4-8 YK	Ceiling thickness adapter (extends mounting frame to accommodate ceiling thickness up to 5"). Adds 1" to fixture height.
FCS 7TSN XXX	Fresco Lighting Control with DMX and ethernet; XXX = Color. Refer to FRESCO spec sheet for additional options.
nPODM 2P DX CCT XX	nLight 2 Channels, On/off + raise/lower control, CCT, XX = Color. Refer to nLight .
nPODM 4S DX XX	nLight 4 Scene Control, On/off + raise/lower control, XX = Color. Refer to nLight .
nPODM 4S XX	nLight 4 Scene Control, XX = Color. Refer to nLight .

ORDERING NOTES

- PROR and RHYR available only with TUWH. HALR available only with WDIM.
- Nominal lumen values when tested at 3500K.
- Not available with aperture finishes.
- Requires power from nLight network bridge or nPS 80.
- For use with different reflector finish only (i.e. AR, PR, WTR, GR options). Not applicable with WR (white reflector) or FL (flangeless) option.
- For use with different reflector finish only (i.e. AR, PR, WTR, GR options). Not applicable with BR (black reflector) or FL (flangeless) option.
- Voltage-specific (120 or 277V). Not available with battery pack options.

Optical Assembly

Fully serviceable and upgradeable lensed LED light engine suitable for field maintenance or service from below the ceiling. Unitized optics shall have mechanical attachment of the light engine to the lower reflector for complete optical alignment.

Electrical

The luminaire shall operate from a 50 or 60 Hz ±3 Hz AC line over a voltage ranging from 120 VAC to 277 VAC. The fluctuations of line voltage shall have no visible effect on the luminous output.

The luminaire shall have a power factor of 90% or greater at all standard operating voltages and full luminaire output.

Sound Rated A+. Driver shall be >80% efficient at full load across all input voltages.

Input wires shall be 18AWG, 300V minimum, solid copper.

Controls

Tunable white nTune™ is an all-digital light color temperature control within an nLight enabled luminaire.

nTune™ allows color temperature settings through the Productivity Range of 3000K to 5000K or Rhythm Range of 2700K to 6500K.

Refer to nLight Programming User's Guide for instructions on customizing your application with SensorView™.

Dimming

The luminaire shall be capable of continuous dimming without perceivable stroboscopic flicker as measured by flicker index (ANSI/IES RP-16-10) over a range of 100 – 0.1% of rated lumen output with a smooth shut off function to step to 0%.

Construction

Luminaire housing shall be constructed of 16-gauge galvanized steel and have preinstalled telescopic mounting bars with maximum 32" and minimum 15" extension and 4" vertical adjustment.

luminaires shall be suitable for installation in ceilings up to 1½" thick. (specify ceiling thickness adapter to extend frame to accommodate ceiling thickness up to 5").

Tool-less adjustments shall be possible after installation.

The assembly and manufacturing process for the luminaire shall be designed to assure all internal components are adequately supported to withstand mechanical shock and vibration.

25°C ambient temperature standard (1/2" clearance on all sides from non-combustible materials in non-IC applications, unless marked spacing noted otherwise).

For use in insulated ceilings, a 3" clearance on all sides from insulation is required (unless marked spacing noted otherwise).

Listings

Fixtures are CSA certified to meet US and Canadian Standards: All fixtures manufactured in strict accordance with the appropriate and current requirements of the "Standards for Safety" to UL, wet location covered ceiling.

Photometrics

LEDs tested to LM-80 standards. Measured by IESNA Standard LM-79-08 in an accredited lab. Lumen output shall not decrease by more than 20% over the minimum operational life of 60,000 hours.

Buy American Act

This product is assembled in the USA and meets the Buy America(n) government procurement requirements under FAR, DFARS and DOT regulations. Please refer to www.acuitybrands.com/buy-american for additional information.

Warranty

5-year limited warranty. Complete warranty terms located at: www.acuitybrands.com/support/customer-support/terms-and-conditions

Note:

Actual performance may differ as a result of end user environment and application.

All values are design or typical values, measured under laboratory conditions at 25 °C.

A+ Capable Luminaire

This item is an A+ capable luminaire, which has been designed and tested to provide consistent color appearance and out-of-the-box control compatibility with simple commissioning.

- All configurations of this luminaire meet the Acuity Brands' specification for chromatic consistency
- This luminaire is part of an A+ Certified solution for nLight® control networks when ordered with drivers marked by a shaded background*
- This luminaire is part of an A+ Certified solution for nLight® control networks, providing advanced control functionality at the luminaire level, when selection includes driver and control options marked by a shaded background*

To learn more about A+, visit www.acuitybrands.com/aplus.

*See ordering tree for details

Flangeless

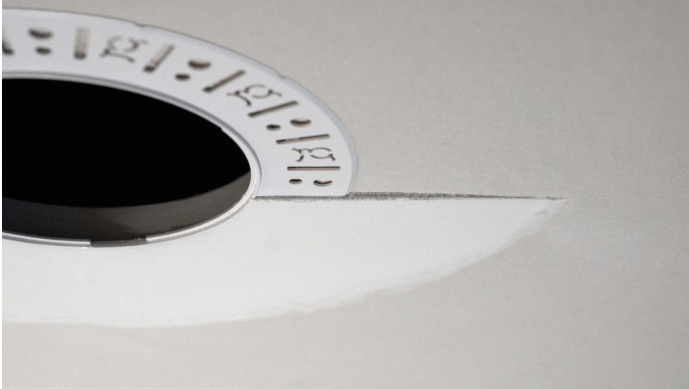

Partially finished mud ring, showing cross-section detail.

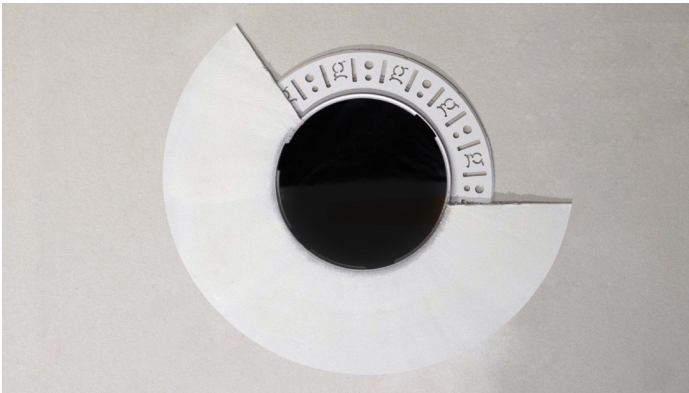

An EVO downlight requires only approximately 3" of plaster to finish.



EVO with flangeless trim

Flangeless Installation

Gotham's flangeless option utilizes a micro-thin polymer mud ring that minimizes the amount of drywall compound required to finish the ceiling. The end result is a virtually undetectable flangeless downlight installation.

The polymer mud ring is installed independent of the of the recessed frame, therefore floating with the ceiling. This innovation minimizes any surface cracks during reflector installation, ceiling movement and any future service to the recessed frame, wiring, electronics, etc.

Lumen Output Multiplier - Finish Trim						
Finish	Clear (AR)	Pewter (PR)	Wheat (WTR)	Gold (GR)	White (WR/WRAMF)	Black (BR)
Specular (LS)	1.00	0.88	0.83	0.95	N/A	N/A
Semi-specular (LSS)	0.95	0.84	0.79	0.90	N/A	N/A
Matte-diffuse (LD)	0.85	0.73	0.69	0.80	N/A	N/A
Paint	N/A	N/A	N/A	N/A	0.87	0.73

Driver Default Dimming Curve			
Nomenclature	Min Dimming	Driver Dim Curve	Control Dim Curve
ZT	0.1%	Linear	Linear/Logarithmic
DALI	0.1%	Linear	Linear/Logarithmic

How to Estimate Delivered Lumens in Emergency Mode

Delivered Lumens = 1.25 x P x LPW

P = Output power of emergency driver. P = 10W for PS1055CP

LPW = Lumen per watt rating of the luminaire. This information is available on the ABL luminaire spec sheet.

MAINSTREAM DYNAMIC TUNABLE WHITE WITH NTUNE TECHNOLOGY

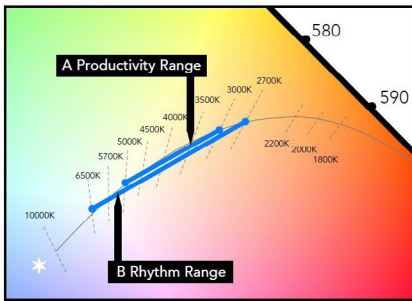

Tunable white nTune™ is an all digital light color temperature control within an nLight enabled luminaire. This brings tunable white lighting control into the mainstream with repeatable, consistent results in an economical luminaire form and system already familiar to schools. Designers and facility operators are granted the freedom to tie scenes to specific activities or to complement colors or materials within a visual environment. nTune™ allows color temperature settings through the Productivity Range of 3000K to 5000K or Rhythm Range of 2700K to 6500K. Refer to nLight Programming User's Guide for instructions on customizing to your application with SensorView™.

TUNABLE WHITE GPHD

Gamut: One dimensional warm-Cool

Path: Direct 3000K to 5000K (Productivity Range) or 2700K to 6500K (Rhythm Range)

Handle: Two Natural Language Handles: Intensity and CCT

Data: nLight with nTune technology for both handles of control

A Productivity Range 3000K to 5000K

B Rhythm Range 2700K to 6500K

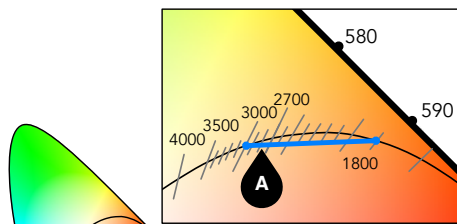

A Halogen Range 3000K to 1800K

DIMENSIONAL DATA

*Dimensions in inches [centimeters]

Aperture: 6 1/4" [15.9]	Ceiling Opening: 7 1/8" [18.1] self-flanged
Overlap Trim: 7 1/2" [19.1]	7 1/4" [18.4] flangeless

Standard

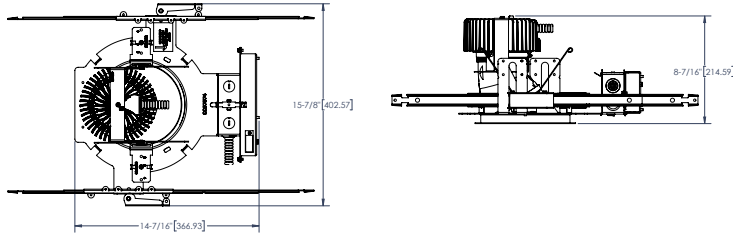

Battery Pack

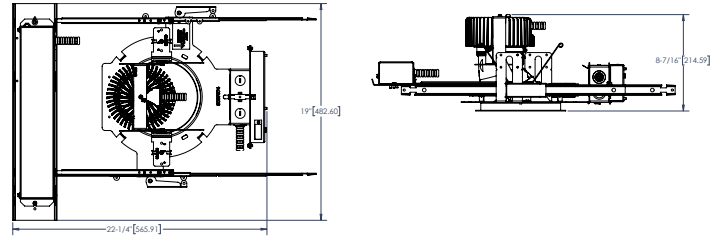

CP Standard

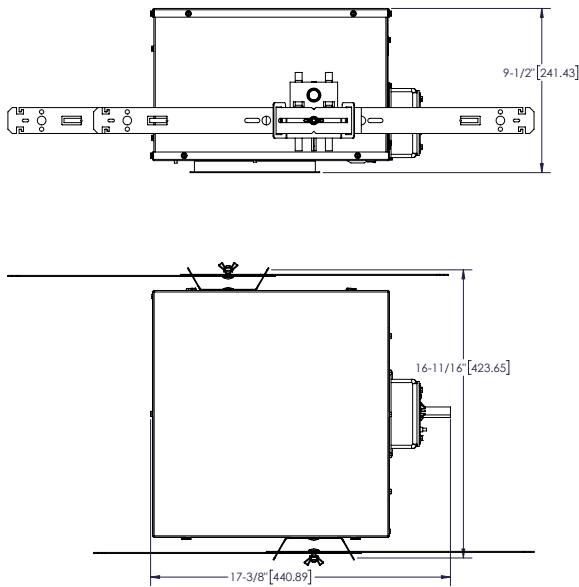

Photometry

EVO6LW TUWH RHYR /45 6AR LS CRI80 2700K

INPUT WATTS: 48.2, DELIVERED LUMENS: 2720, LM/W=56.4, WALLWASH, TEST NO. 19-031-06P97

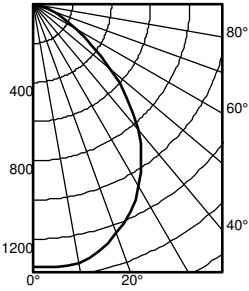

Ave Lumens	Zone Lumens % Lamp	pf pc pw	80%			20% 70%			50%					
			50%	30%	10%	50%	30%	10%	50%	30%	10%			
0	1344	0° - 30°	1033.7	38.0	0	119	119	119	116	116	116	111	111	111
5	1350	0° - 40°	1633.5	60.0	1	107	104	101	105	102	99	101	98	96
15	1307	0° - 60°	2490.1	91.5	2	96	91	86	94	89	85	91	87	83
25	1172	0° - 90°	2720.2	100.0	3	86	79	74	85	78	73	82	76	72
35	963	90° - 180°	0.0	0.0	4	78	70	64	77	69	64	74	68	63
45	678	0° - 180°	2720.2	*100.0	5	70	63	57	69	62	56	67	61	56
55	372	*Efficiency			6	64	56	50	63	56	50	62	55	50
65	164				7	59	51	45	58	50	45	56	50	45
75	52				8	54	46	41	53	46	41	52	45	41
85	2				9	50	42	37	49	42	37	48	42	37
90	0				10	46	39	34	46	39	34	45	38	34

Mounting Height	Initial FC Center Beam	50% beam - 61.6°		10% beam - 100.4°	
		Diameter	FC	Diameter	FC
8.0	44.4	6.6	22.2	13.2	4.4
10.0	23.9	8.9	11.9	18.0	2.4
12.0	14.9	11.3	7.4	22.8	1.5
14.0	10.2	13.7	5.1	27.6	1.0
16.0	7.4	16.1	3.7	32.4	0.7

EVO6LW TUWH RHYR /45 6AR LS CRI80 3500K

INPUT WATTS: 48.2, DELIVERED LUMENS: 2736, LM/W=56.7, WALLWASH, TEST NO. 19-031-06P99

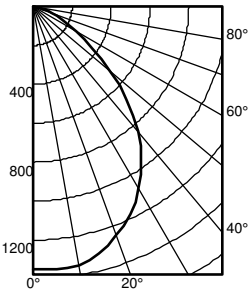

Ave Lumens	Zone Lumens % Lamp	pf pc pw	80%			20% 70%			50%					
			50%	30%	10%	50%	30%	10%	50%	30%	10%			
0	1351	0° - 30°	1039.5	38.0	0	119	119	119	116	116	116	111	111	111
5	1357	0° - 40°	1642.6	60.0	1	107	104	101	105	102	99	101	98	96
15	1314	0° - 60°	2504.0	91.5	2	96	91	86	94	89	85	91	87	83
25	1178	0° - 90°	2735.4	100.0	3	86	79	74	85	78	73	82	76	72
35	968	90° - 180°	0.0	0.0	4	78	70	64	77	69	64	74	68	63
45	681	0° - 180°	2735.4	*100.0	5	70	63	57	69	62	56	67	61	56
55	374	*Efficiency			6	64	56	50	63	56	50	62	55	50
65	165				7	59	51	45	58	50	45	56	50	45
75	52				8	54	46	41	53	46	41	52	45	41
85	2				9	50	42	37	49	42	37	48	42	37
90	0				10	46	39	34	46	39	34	45	38	34

Mounting Height	Initial FC Center Beam	50% beam - 61.6°		10% beam - 100.4°	
		Diameter	FC	Diameter	FC
8.0	44.7	6.6	22.3	13.2	4.5
10.0	24.0	8.9	12.0	18.0	2.4
12.0	15.0	11.3	7.5	22.8	1.5
14.0	10.2	13.7	5.1	27.6	1.0
16.0	7.4	16.1	3.7	32.4	0.7

EVO6LW TUWH RHYR /45 6AR LS CRI80 6500K

INPUT WATTS: 48.2, DELIVERED LUMENS: 2952, LM/W=61.2, WALLWASH, TEST NO. 19-031-06P102

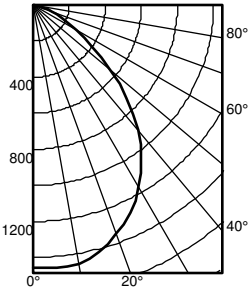

Ave Lumens	Zone Lumens % Lamp	pf pc pw	80%			20% 70%			50%					
			50%	30%	10%	50%	30%	10%	50%	30%	10%			
0	1458	0° - 30°	1121.8	38.0	0	119	119	119	116	116	116	111	111	111
5	1465	0° - 40°	1772.6	60.0	1	107	104	101	105	102	99	101	98	96
15	1418	0° - 60°	2702.2	91.5	2	96	91	86	94	89	85	91	87	83
25	1271	0° - 90°	2951.9	100.0	3	86	79	74	85	78	73	82	76	72
35	1045	90° - 180°	0.0	0.0	4	78	70	64	77	69	64	74	68	63
45	735	0° - 180°	2951.9	*100.0	5	70	63	57	69	62	56	67	61	56
55	403	*Efficiency			6	64	56	50	63	56	50	62	55	50
65	178				7	59	51	45	58	50	45	56	50	45
75	56				8	54	46	41	53	46	41	52	45	41
85	2				9	50	42	37	49	42	37	48	42	37
90	0				10	46	39	34	46	39	34	45	38	34

Mounting Height	Initial FC Center Beam	50% beam - 61.6°		10% beam - 100.4°	
		Diameter	FC	Diameter	FC
8.0	48.2	6.6	24.1	13.2	4.8
10.0	25.9	8.9	13.0	18.0	2.6
12.0	16.2	11.3	8.1	22.8	1.6
14.0	11.0	13.7	5.5	27.6	1.1
16.0	8.0	16.1	4.0	32.4	0.8

nLight® The nLight® solution is a digital networked lighting control system that provides both energy savings and increased user configurability by cost effectively integrating time-based, daylight-based, sensor-based and manual lighting control schemes.

Possibilities for nLight® wired

Fixtures ordered *without* the NLT option

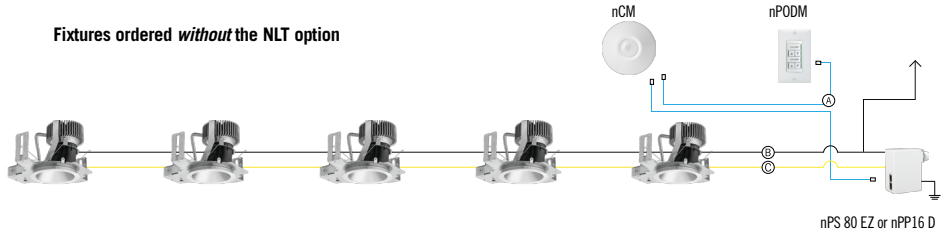

Fixtures ordered *with* the NLT option

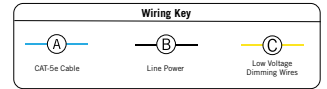
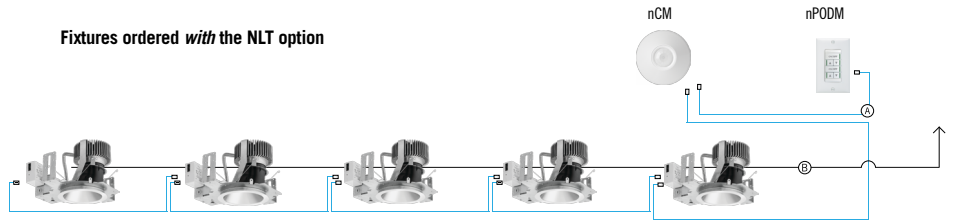

nLight® Wired Control Accessories

Order as separate catalog number. Visit [nLight](http://nLight.com).

Wall Switches	Model Number
On/Off single pole	nPODM (color)
On/Off two pole	nPODM 2P (color)
On/Off & raise/lower single pole	nPOD DX (color)
On/Off & raise/lower two pole	nPODM 2P DX (color)
Graphic touchscreen	nPOD GFX (color)

Photocell Controls	Model Number
Dimming	nCM ADCX

nLight® Wired Control Accessories (cont.)

Occupancy Sensors (PIR/dual tech)	Model Number
Small motion 360°, ceiling	nCM 9 / nCM PDT 9
Large motion 360°, ceiling	nCM 10 / nCM PDT 10
Wide View	nWV 16 / nWV PDT 16
Wall switch with raise/lower	nWSX LV DX / nWSX PDT LV DX

Cat-5 Cables (plenum rated)	Model Number
10', CAT5	CAT5 10FT J1
15', CAT5	CAT5 15FT J1