

OVERVIEW

COMPLEMENTARY PRODUCTS

High Center Beam Round Shower Downlight 2"



Feature Set

- Seven optimized distribution patterns allow designers to achieve tailored objectives
- Field interchangeable optic
- Driver and LED light engine fully serviceable from below ceiling
- 70% lumen maintenance at 60,000 hours
- 2.5 SDCM; 85 CRI typical, 90+ CRI optional
- Non conductive, dead front construction
- IP66 rated room-side, fixtures are wet location, covered ceiling
- Impact resistant, polycarbonate lens
- Available with metalized or painted finishes
- Can be paired with complimentary recessed adjustable shower luminaires

Distribution

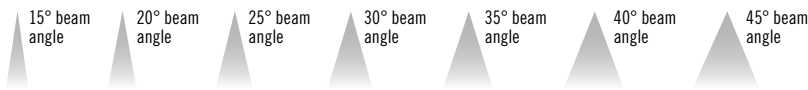

Superior Performance

Nominal lumen	250	500	750	1000	1500	2000
Delivered	220	468	717	982	1472	1859
Wattage	3.1	5.6	8.6	12.0	19.7	28.4
Efficacy	71	84	83	82	75	65

*Based on 3500K 80CRI 15D AR LSS SMO

Coordinated Apertures | Multiple Layers of Light



General Illumination Layer | EVO



High Center Beam Layer | Incito



EVO + Incito — Multiple Layers of Light

Core	Downlight	Adjustable	Open Wallwash	Lensed Wallwash	Cylinder	Pinhole	Bevel	Hyperbolic
Healthcare	MRI	Surgical Suite	Patient Room					
Special Applications	Dynamic	Food Service	Vandal/Tamper	Clean Room	Shower	Steam Room		

A+ Capable options indicated by this color background.

Luminaire Type:

Catalog Number:

EXAMPLE: IC02SH 35/10 AR LSS SOL 20D MVOLT UGZ

Series	Color Temperature	Lumens	Reflector Color	Reflector Finish	Lensing	Beam
IC02SH Incito 2in Round Shower Downlight	27/ 2700 K	02 250 lumens	AR Clear	LSS Semi-specular	SOL Solite pattern lens	15D 15° beam angle
	30/ 3000 K	05 500 lumens	PR Pewter	LD Matte diffuse	LTF Light frost lens	20D 20° beam angle
	35/ 3500 K	07 750 lumens	WTR Wheat		SMO Clear	25D 25° beam angle
	40/ 4000 K	10 1000 lumens	GR Gold			30D 30° beam angle
	50/1 5000 K	15 1500 lumens 20 2000 lumens	WR ² White painted BR ² Black BZR ² Dark Bronze painted			35D 35° beam angle 40D 40° beam angle 45D 45° beam angle

Voltage	Driver	Control Interface ⁴	Options
MVOLT 120V - 277V 120 120V 277 277V	UGZ ³ Universal dimming to 1% (0-10V, 120V TRIAC or ELV)	(blank) NLT nLight® dimming pack. NLTER ⁵ nLight® dimming pack for fixtures on emergency circuit NLTAIR2 nLight® AIR dimming pack. NLTAIRER2 ⁹ nLight® AIR dimming pack for fixtures on emergency circuit NLTAIREM2 nLight® AIR dimming pack for fixtures on emergency circuit	90CRI ¹ High CRI (90+) NCH ⁶ Structural reinforcement pan ICAT ⁷ IC/Airtight housing construction CP ⁷ Chicago Plenum HAO ⁸ High ambient (40°C) N80 ¹¹ nLight Lumen Compensation TRW ⁹ White painted flange TRBL ¹⁰ Black painted flange

ACCESSORIES — order as separate catalog numbers (shipped separately)

IC02OPTC XXD	Additional optics for field installation. Replace "XX" with beam angle.
IC02OPTC KIT	Kit including a field interchangeable optic for each of the 13 preset beam distribution patterns
HS258	2-5/8" Hole saw
SDT 347/120 75VA	347V/120V, 75VA step down transformer. Must be remote mounted.

ORDERING NOTES

- 5000K CCT not available with 90CRI.
- Not available with Reflector Finish.
- Refer to [Tech 240](#) for compatible dimmers.
- Field installed. Access required to location of remote mounted device.
- ER for use with generator supply power. Will require an emergency hot feed and normal hot feed.
- NCH is required for T-grid ceilings or where code requires.
- Not available with 1500lm or 2000lm.
- Not available with 2000lm.
- For use with different reflector finish only (i.e. AR, PR, WTR, GR options). Not available with WR (White Reflector). Not available with FL.
- For use with different reflector finish only (i.e. AR, PR, WTR, GR options). Not available with BR (Black Reflector). Not available with FL.
- Requires NLT or NLTER.

Optical and Trim Assembly

Fully serviceable and upgradeable lensed LED light engine suitable for field maintenance or service from above or below the ceiling. Superior 100% Virgin-silicone refractive optic, enables maximum dimensional stability and optical transmission with no discoloration over life. Field inter-changeable optics. Wet paint and metalized finish.

Electrical

The luminaire shall operate from a 50 or 60 Hz ±3 Hz AC line over a voltage ranging from 120 VAC to 277 VAC. Support 347V via remote-mounted stepdown transformer. The fluctuations of line voltage shall have no visible effect on the luminous output. The luminaire shall have a power factor of 90% or greater at all standard operating voltages and full luminaire output. Sound Rated A+. Driver shall be >80% efficient at full load across all input voltages.

Controls

Luminaire shall be equipped with interface for nLight wired or nLight AIR networks with integral power supply as per specification.

Dimming

The luminaire shall be capable of continuous dimming without perceivable stroboscopic flicker as measured by flicker index (ANSI/IES RP-16-10) over a range of 100 – 1.0% of rated lumen output with a smooth shut off function to step to 0%. Driver is inaudible in 24dB environment, and stable when input voltage conditions fluctuate over what is typically experienced in a commercial environment.

Construction

Light engine and driver are accessible from below ceiling. Several additional mounting options available including a structural reinforcement pan, Chicago plenum, and Type IC. Anodized extruded aluminum wiring compartment with hinged access. With two 1/2" trade-sized knockouts rated for 90°C. Accommodates between 3/8" to 2-3/4"-thick ceilings.

Listings

Fixtures are UL Certified to meet US and Canadian Standards: All fixtures manufactured in strict accordance with the appropriate and current requirements of the "Standards for Safety" to UL, wet location covered ceiling. IC rated with ICAT option. Fixtures with ICAT option are compatible with spray foam insulation with an R-value of 4.3 per inch or less.

Photometrics

LEDs tested to LM-80 standards. Measured by IESNA Standard LM-79-08 in an accredited lab. Lumen output shall not decrease by more than 30% over the minimum operational life of 60,000 hours. Color appearance from luminaire to luminaire of the same type and in all configurations, shall be consistent both initially and at 6,000 hours and operate within a tolerance of <2.5 MacAdam ellipse as defined by the center of the quadrangles defined in ANSI C78.377-2015.

Government Procurement

BAA - Buy America(n) Act: Product qualifies as a domestic end product under the Buy American Act as implemented in the FAR and DFARS. Product also qualifies as manufactured in the United States under DOT Buy America regulations
 BABA - Build America Buy America: Product qualifies as produced in the United States under the definitions of the Build America, Buy America Act
 Please refer to www.acuitybrands.com/buy-american for additional information

Warranty

5-year limited warranty. This is the only warranty provided and no other statements in this specification sheet create any warranty of any kind. All other express and implied warranties are disclaimed. Complete warranty terms located at: www.acuitybrands.com/support/warranty/terms-and-conditions

Note:

Actual performance may differ as a result of end user environment and application. All values are design or typical values, measured under laboratory conditions at 25 °C.

A+ Capable Luminaire

This item is an A+ capable luminaire, which has been designed and tested to provide consistent color appearance and out-of-the-box control compatibility with simple commissioning.

- All configurations of this luminaire meet the Acuity Brands' specification for chromatic consistency
- This luminaire is part of an A+ Certified solution for nLight® control networks when ordered with drivers marked by a shaded background*
- This luminaire is part of an A+ Certified solution for nLight® control networks, providing advanced control functionality at the luminaire level, when selection includes driver and control options marked by a shaded background*

To learn more about A+, visit www.acuitybrands.com/aplus.

*See ordering tree for details

Lumen Output Multiplier		
CRI	CCT	Multiplier
80	2700K	0.910
	3000K	0.946
	3500K	1.000
	4000K	1.027
	5000K	1.054
90	2700K	0.784
	3000K	0.847
	3500K	0.874
	4000K	0.946

Reflector Finish Multiplier	
Reflector Finish	Multiplier
LSS - Semi Specular	1.00
LD - Matte Diffuse	1.06
Reflector Color	Multiplier
WR - White	1.05
BR - Black	0.65
BZR - Bronze	0.61
AR - Clear	1.00
GR - Gold	0.93
PR - Pewter	0.98
WTR - Wheat	0.99

Driver		Control Provided				
Nomenclature	Description	NLT	NLTER	NLTAIR2	NLTAIREM2	NLTAIRER2
UGZ	0-10V driver dims to 1%	nPP16 D EFP	nPP16 D ER EFP	RPP20 D 24V G2	RPP20 D 24V EM G2	RPP20 D 24V ER G2

Marked Spacing in Inches 25°C Ambient			
Lumen Package	Fixed Center to Center MIN	Fixture Center to Building Member MIN	Space Above Fixture
2000	18	9	3
1500 (HAO)	18	9	3

*Dimensions in inches [centimeters]

Aperture: 2-1/4" [5.7]

Ceiling Opening: 2-5/8" [6.7] self-flanged

Overlap Trim: 3" [7.6]

2-3/4" [7] flangeless

Recessed Application - Minimum Clearance Requirements

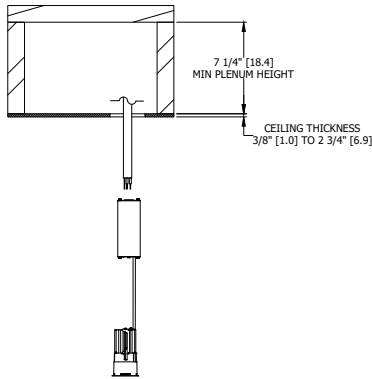

Structural Reinforcement Pan

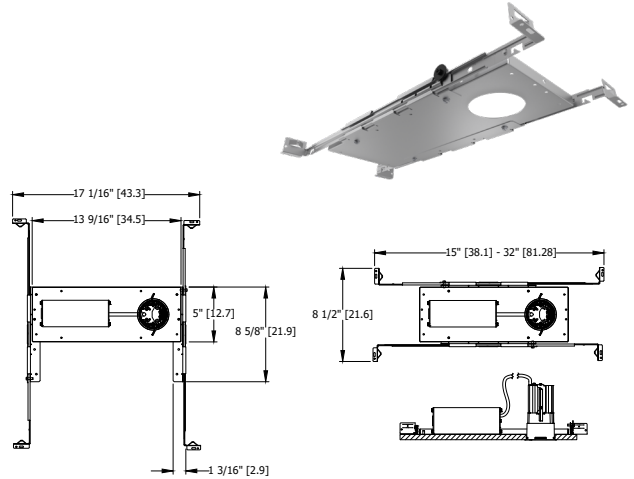

1000 Lumen and Below Install-from-Below Construction

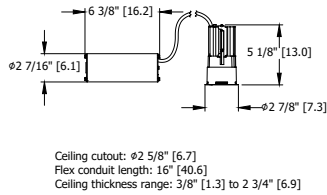

IC / Airtight Housing / Chicago Plenum Construction

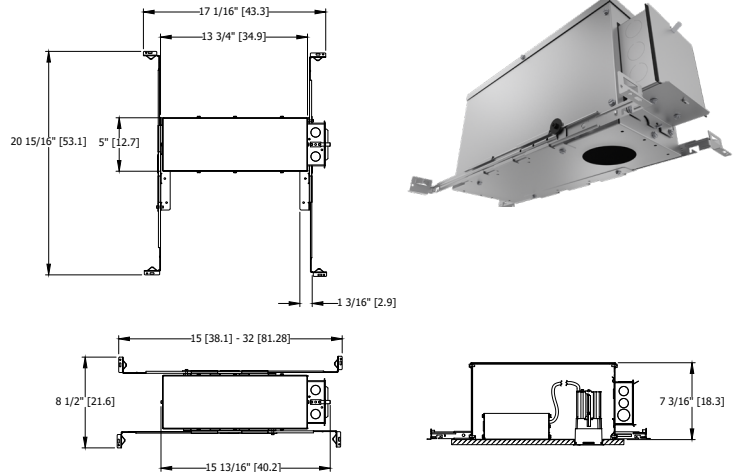

1500 and 2000 Lumen or High Ambient Option Install-from-Below Construction

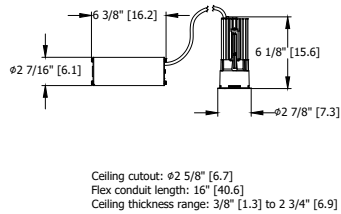

347V Transformer

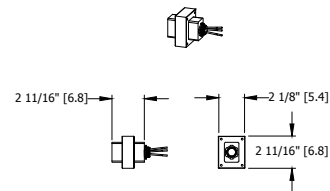

347 Transformer:
Install to accessible
junction box by others

Photometry

CONSULT WWW.GOTHAMLIGHTING.COM FOR ADDITIONAL PHOTOMETRY

ICO2SH 35/15 AR LSS SMO 15D Input Watts: 19.7, Delivered Lumens: 1472, LPW: 74.7, S/MH: 0.28, Test No: 19-457-08P197

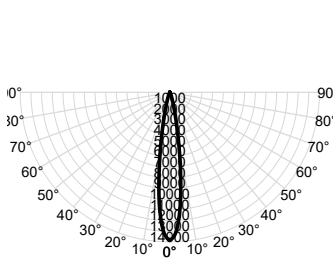

CP Summary		Zonal Lumen Summary		Coefficients of Utilization						Cone of Light			Luminance (cd/sq.m)					
0°	Zone	Lumens	% Fixture	pf pc	80%		20%		Mounting Height	Initial FC Center Beam	Beam Diameter	Average Luminance						
				pw	50%	30%	10%	50%					30%	10%	50%	30%	10%	
0°	0° - 30°	1,412	96%	0	119	119	119	116	116	116	111	111	111	6.0	384.4	1.7	0°	5,853,743
5°	0° - 40°	1,454	99%	1	114	112	110	112	110	109	108	106	105	8.0	216.2	2.3	45°	10,050
15°	0° - 60°	1,470	100%	2	109	107	104	108	105	103	105	103	101	10.0	138.4	2.9	55°	2,065
25°	0° - 90°	1,472	100%	3	105	102	100	104	101	99	102	99	98	12.0	96.1	3.5	65°	1,301
35°	90° - 180°	0	0%	4	102	99	96	101	98	96	99	97	95	14.0	70.6	4.0	75°	654
45°	0° - 180°	1,472	100%	5	99	96	93	99	95	93	97	94	92				85°	0
55°				6	97	93	91	96	93	91	95	92	90					
65°				7	95	91	89	94	91	89	93	90	88					
75°				8	93	89	87	92	89	87	91	88	86					
85°				9	91	87	85	90	87	85	90	87	85					
90°				10	89	86	84	89	86	84	88	85	83					

ICO2SH 35/15 AR LSS SMO 30D Input Watts: 19.7, Delivered Lumens: 1344, LPW: 68.2, S/MH: 0.50, Test No: 19-457-11P197

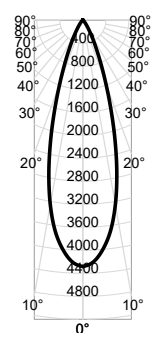

CP Summary		Zonal Lumen Summary		Coefficients of Utilization						Cone of Light			Luminance (cd/sq.m)					
0°	Zone	Lumens	% Fixture	pf pc	80%		20%		Mounting Height	Initial FC Center Beam	Beam Diameter	Average Luminance						
				pw	50%	30%	10%	50%					30%	10%	50%	30%	10%	
0°	0° - 30°	1,220	91%	0	119	119	119	116	116	116	111	111	111	6.0	118.9	3.2	0°	1,811,222
5°	0° - 40°	1,309	97%	1	112	110	108	110	108	107	106	105	104	8.0	66.9	4.3	45°	20,698
15°	0° - 60°	1,342	100%	2	107	103	101	105	102	99	102	99	97	10.0	42.8	5.4	55°	2,876
25°	0° - 90°	1,344	100%	3	101	97	94	100	96	94	98	95	92	12.0	29.7	6.5	65°	1,902
35°	90° - 180°	0	0%	4	97	92	89	96	92	89	94	90	88	14.0	21.8	7.6	75°	981
45°	0° - 180°	1,344	100%	5	93	88	85	92	88	84	90	86	84				85°	0
55°				6	89	84	81	88	84	81	87	83	80					
65°				7	85	81	78	85	80	77	84	80	77					
75°				8	82	78	74	82	77	74	81	77	74					
85°				9	79	75	72	79	75	72	78	74	71					
90°				10	77	72	69	76	72	69	76	72	69					

ICO2SH 35/15 AR LSS SMO 45D Input Watts: 19.7, Delivered Lumens: 1321, LPW: 67.1, S/MH: 0.71, Test No: 19-457-14P197

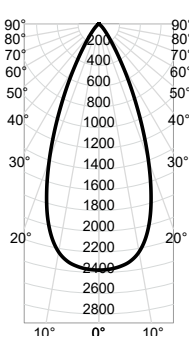

CP Summary		Zonal Lumen Summary		Coefficients of Utilization						Cone of Light			Luminance (cd/sq.m)					
0°	Zone	Lumens	% Fixture	pf pc	80%		20%		Mounting Height	Initial FC Center Beam	Beam Diameter	Average Luminance						
				pw	50%	30%	10%	50%					30%	10%	50%	30%	10%	
0°	0° - 30°	1,131	86%	0	119	119	119	116	116	116	111	111	111	6.0	66.0	4.8	0°	1,005,036
5°	0° - 40°	1,271	96%	1	112	109	107	110	108	106	106	104	103	8.0	37.1	6.4	45°	30,748
15°	0° - 60°	1,318	100%	2	105	102	99	103	100	97	100	98	95	10.0	23.8	8.0	55°	2,950
25°	0° - 90°	1,321	100%	3	99	95	91	98	94	91	95	92	89	12.0	16.5	9.6	65°	2,002
35°	90° - 180°	0	0%	4	94	89	85	93	88	85	91	87	84	14.0	12.1	11.2	75°	981
45°	0° - 180°	1,321	100%	5	89	84	80	88	83	80	86	82	79				85°	0
55°				6	85	79	76	84	79	75	82	78	75					
65°				7	81	75	72	80	75	71	79	74	71					
75°				8	77	72	68	76	71	68	75	71	68					
85°				9	73	68	65	73	68	65	72	68	64					
90°				10	70	65	62	70	65	62	69	65	62					

nLight® AIR is the ideal solution for retrofit or new construction spaces where adding communication wiring is cost prohibitive. The integrated nLight AIR rPP20 Power Pack is part of each EVO Luminaire ordered with the NLTAIR option. These individually addressable controls offer the ultimate in flexibility during initial setup and for space repurposing.

Possibilities for nLight® AIR

Fixtures ordered *without* the NLTAIR option

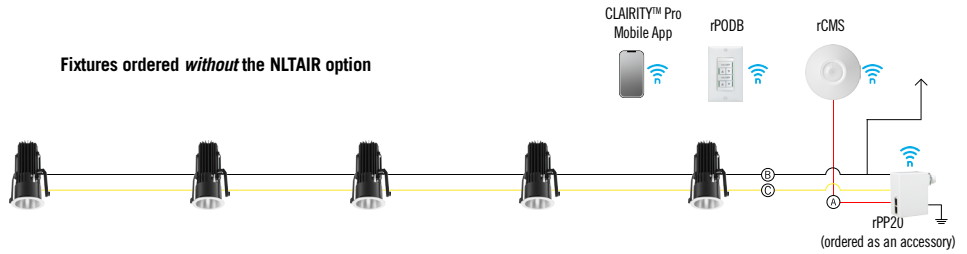

Fixtures ordered *with* the NLTAIR option

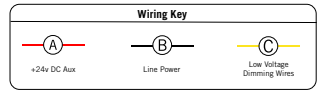
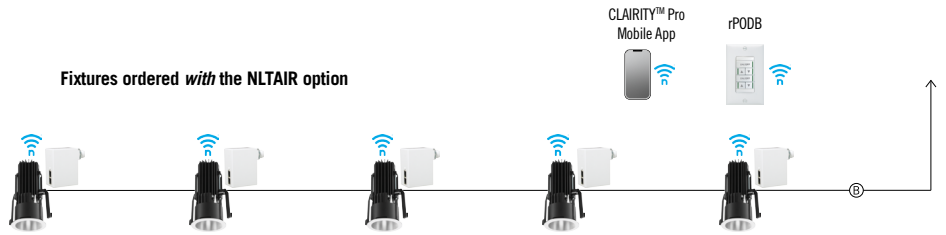

nLight® AIR Control Accessories

Order as separate catalog number. Visit [nLight AIR](#).

Wall Switches	Model Number
On/Off single pole	rPODB (color) G2
On/Off two pole	rPODB 2P (color) G2
On/Off & raise/lower single pole	rPODB DX (color) G2
On/Off & raise/lower two pole	rPODB 2P DX (color) G2

nLight® AIR Control Accessories (cont.)

Occupancy Sensors (PIR/dual tech)	Model Number
Small motion 360°, ceiling	rCMS 9 / rCMS PDT 9
Large motion 360°, ceiling	rCMS 10 / rCMS PDT 10

nLight® Wired The nLight® solution is a digital networked lighting control system that provides both energy savings and increased user configurability by cost effectively integrating time-based, daylight-based, sensor-based and manual lighting control schemes.

Possibilities for nLight® wired

Fixtures ordered *without* the NLT option

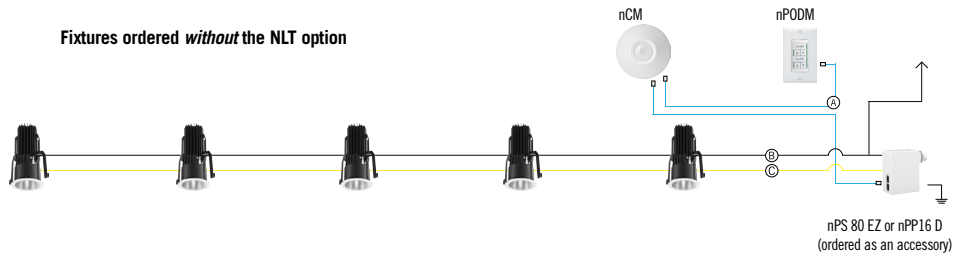

Fixtures ordered *with* the NLT option

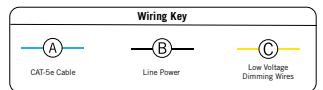
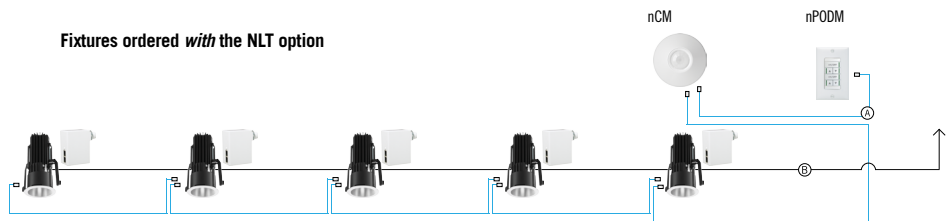

nLight® Wired Control Accessories

Order as separate catalog number. Visit [nLight](#).

Wall Switches	Model Number
On/Off single pole	nPODM (XX)
On/Off two pole	nPODM 2P (XX)
On/Off & raise/lower single pole	nPOD DX (XX)
On/Off & raise/lower two pole	nPODM 2P DX (XX)
Graphic touchscreen	nPOD GFX (XX)

Photocell Controls

Dimming	nCM ADCX
---------	----------

nLight® Wired Control Accessories (cont.)

Occupancy Sensors (PIR/dual tech)	Model Number
Small motion 360°, ceiling	nCM 9 / nCM PDT 9
Large motion 360°, ceiling	nCM 10 / nCM PDT 10
Wide View	nWV 16 / nWV PDT 16
Wall switch with raise/lower	nWSX LV DX / nWSX PDT LV DX

Cat-5 Cables (plenum rated)	Model Number
10', CAT5	CAT5 10FT J1
15', CAT5	CAT5 15FT J1