



D-Series Size 0

Legacy LED Area Luminaire



Catalog Number
Notes
Type

Hit the Tab key or mouse over the page to see all interactive elements.

Introduction

The modern styling of the D-Series is striking yet unobtrusive - making a bold, progressive statement even as it blends seamlessly with its environment. The D-Series distills the benefits of the latest in LED technology into a high performance, high efficacy, long-life luminaire.

The outstanding photometric performance results in sites with excellent uniformity, greater pole spacing and lower power density. It is ideal for replacing up to 400W metal halide with typical energy savings of 70% and expected service life of over 100,000 hours.

Specifications

EPA:	0.95 ft ² (.09 m ²)
Length:	26" (66.0 cm)
Width:	13" (33.0 cm)
Height ₁ :	3" (7.62 cm)
Height ₂ :	7" (17.8 cm)
Weight (max):	16 lbs (7.25 kg)

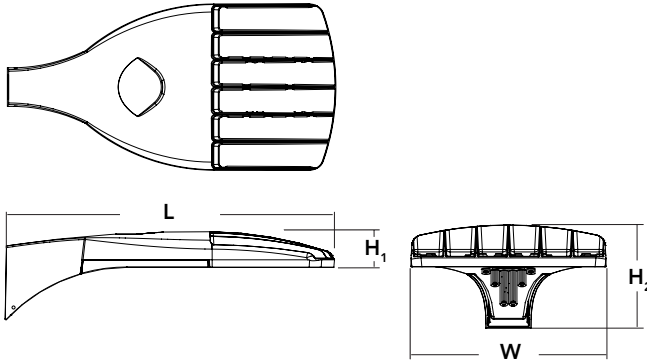

Ordering Information

EXAMPLE: DSX0 LED P6 40K T3M MVOLT SPA NLTAIR2 PIRHN DDBXD G1

DSX0 LED	Series	LEDs	Color temperature	Distribution	Voltage	Mounting		
DSX0 LED	Forward optics	P1 P5	30K 3000 K	T1S Type I short (Automotive)	T5S Type V short ³	MVOLT (120V-277V) ^{5,6}	Shipped included SPA Square pole mounting RPA Round pole mounting ¹⁰ WBA Wall bracket ³ SPUMBA Square pole universal mounting adaptor ¹¹ RPUMBA Round pole universal mounting adaptor ¹¹ Shipped separately KMA8 DDBXD U Mast arm mounting bracket adaptor (specify finish) ¹²	
		P2 P6	40K 4000 K	T2S Type II short	T5M Type V medium ³	XVOLT (277V-480V) ^{7,8,9}		
		P3 P7 ¹	50K 5000 K	T2M Type II medium	T5W Type V wide ³	120 ⁶		
		P4 ¹		T3S Type III short	BLC Backlight control ⁴	208 ⁶		
		Rotated optics	P10 ² P12 ²		T3M Type III medium	LCCO Left corner cutoff ⁴		240 ⁶
			P11 ² P13 ^{1,2}		T4M Type IV medium	RCCO Right corner cutoff ⁴		277 ⁶
				TFTM Forward throw medium		347 ⁶		
				T5VS Type V very short ³		480 ⁶		

Control options	Other options	Finish (required)	Generation (required)
Shipped installed NLTAIR2 nLight AIR generation 2 enabled ^{13,14} PIRHN Network, high/low motion/ambient sensor ¹⁵ PER NEMA twist-lock receptacle only (control ordered separate) ¹⁶ PER5 Five-pin receptacle only (control ordered separate) ^{16,17} PER7 Seven-pin receptacle only (leads exit fixture) (control ordered separate) ^{16,17} DMG 0-10V dimming extend out back of housing for external control (control ordered separate) ¹⁸	Shipped installed HS House-side shield ²² SF Single fuse (120, 277, 347V) ⁶ DF Double fuse (208, 240, 480V) ⁶ L90 Left rotated optics ² R90 Right rotated optics ² DDL Diffused drop lens ²² HA 50°C ambient operations ¹ Shipped separately BS Bird spikes ²³ EGS External glare shield	DDBXD Dark bronze DBLXD Black DNAXD Natural aluminum DWHXD White DDBTXD Textured dark bronze DBLBXD Textured black DNATXD Textured natural aluminum DWHGXD Textured white	G1 Generation 1



Ordering Information

Accessories

Ordered and shipped separately.

DLL127F 1.5 JU	Photocell - SSL twist-lock (120-277V) ²⁴
DLL347F 1.5 CUL JU	Photocell - SSL twist-lock (347V) ²⁴
DLL480F 1.5 CUL JU	Photocell - SSL twist-lock (480V) ²⁴
DSHORT SBK U	Shorting cap ²⁴
DSX0HS 20C G1 U	House-side shield for P1,P2,P3 and P4 ²²
DSX0HS 30C G1 U	House-side shield for P10,P11,P12 and P13 ²²
DSX0HS 40C G1 U	House-side shield for P5,P6 and P7 ²²
DSX0DDL G1 U	Diffused drop lens (polycarbonate) ²²
PUMBA DDBXD G1 U*	Square and round pole universal mounting bracket adaptor (specify finish) ²⁵
KMA8 DDBXD U	Mast arm mounting bracket adaptor (specify finish) ²²
DSX0EGS (FINISH) G1 U	External glare shield

For more control options, visit [DTL](#) and [ROAM](#) online. Link to [nLight Air 2](#)

NOTES

- 1 HA not available with P4, P7, and P13.
- 2 P10, P11, P12 and P13 and rotated options (L90 or R90) only available together.
- 3 Any Type 5 distribution with photocell, is not available with WBA.
- 4 Not available with HS or DDL.
- 5 MVOLT driver operates on any line voltage from 120-277V (50/60 Hz).
- 6 Single fuse (SF) requires 120V, 277V or 347V. Double fuse (DF) requires 208V, 240V or 480V. XVOLT not available with fusing (SF or DF).
- 7 XVOLT only suitable for use with P4, P7 and P13.
- 8 XVOLT operates with any voltage between 277V and 480V.
- 9 XVOLT not available with fusing (SF or DF) and not available with PIR, PIRH, PIR1FC3V, PIRH1FC3V.
- 10 Suitable for mounting to round poles between 3.5" and 12" diameter.
- 11 Universal mounting brackets intended for retrofit on existing pre-drilled poles only. 1.5 G vibration load rating per ANCI C136.31. Only usable when pole's drill pattern is NOT Lithonia template #8.
- 12 Must order fixture with SPA mounting. KMA8 must be ordered as a separate accessory; see Accessories information. For use with 2-3/8" diameter mast arm (not included).
- 13 Must be ordered with PIRHN.
- 14 Sensor cover available only in dark bronze, black, white and natural aluminum colors.
- 15 Must be ordered with NLTAIR2. For more information on nLight Air 2 visit [this link](#).
- 16 Photocell ordered and shipped as a separate line item from Acuity Brands Controls. See accessories. Shorting Cap included.
- 17 If ROAM[®] node required, it must be ordered and shipped as a separate line item from Acuity Brands Controls. Shorting Cap included.
- 18 DMG not available with PIRHN, PER5, PER7, PIR, PIRH, PIR1FC3V or PIRH1FC3V, FAO.
- 19 Reference Controls Options table on page 4.
- 20 Reference Motion Sensor Default Table on page 4 to see functionality.
- 21 Not available with other dimming controls options.
- 22 Not available with BLC, LCCO and RCCO distribution.
- 23 Must be ordered with fixture for factory pre-drilling.
- 24 Requires luminaire to be specified with PER, PER5 or PER7 option. See Controls Table on page 4.
- 25 For retrofit use only. Only usable when pole's drill pattern is NOT Lithonia template #8.

EGS – External Glare Shield

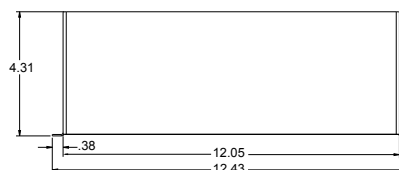
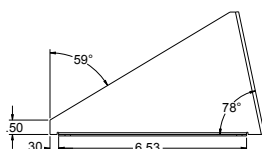
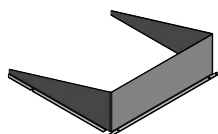

Drilling

HANDHOLE ORIENTATION (from top of pole)

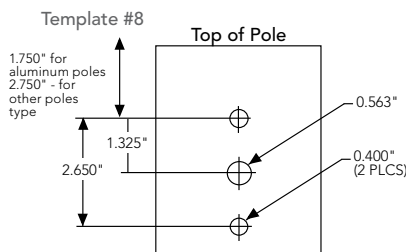
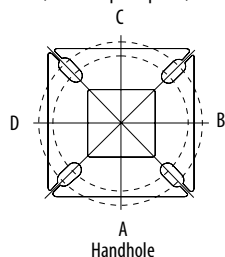

Tenon Mounting Slipfitter

Tenon O.D.	Mounting	Single Unit	2 @ 180	2 @ 90	3 @ 90	3 @ 120	4 @ 90
2-3/8"	RPA	AS3-5 190	AS3-5 280	AS3-5 290	AS3-5 390	AS3-5 320	AS3-5 490
2-7/8"	RPA	AST25-190	AST25-280	AST25-290	AST25-390	AST25-320	AST25-490
4"	RPA	AST35-190	AST35-280	AST35-290	AST35-390	AST35-320	AST35-490

Mounting Option	Drilling Template	Single	2 @ 180	2 @ 90	3 @ 90	3 @ 120	4 @ 90
Head Location		Side B	Side B & D	Side B & C	Side B, C & D	Round Pole Only	Side A, B, C & D
Drill Nomenclature	#8	DM19AS	DM28AS	DM29AS	DM39AS	DM32AS	DM49AS
Minimum Acceptable Outside Pole Dimension							
SPA	#8	2-7/8"	2-7/8"	3.5"	3.5"		3.5"
RPA	#8	2-7/8"	2-7/8"	3.5"	3.5"	3"	3.5"
SPUMBA	#5	2-7/8"	3"	4"	4"		4"
RPUMBA	#5	2-7/8"	3.5"	5"	5"	3.5"	5"

DSX0 Area Luminaire - EPA

*Includes luminaire and integral mounting arm. Other tenons, arms, brackets or other accessories are not included in this EPA data.

Fixture Quantity & Mounting Configuration	Single DM19	2 @ 180 DM28	2 @ 90 DM29	3 @ 90 DM39	3 @ 120 DM32	4 @ 90 DM49
Mounting Type						
DSX0 LED	0.950	1.900	1.830	2.850	2.850	3.544

Isofootcandle plots for the DSX0 LED P6 40K G1. Distances are in units of mounting height (20').

LEGEND

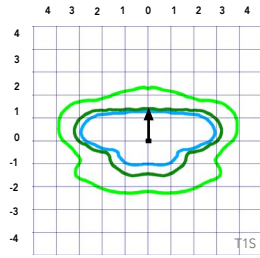
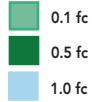

Test No.

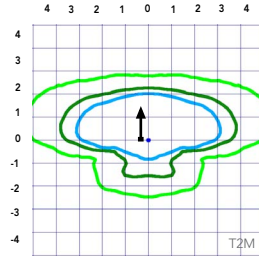

Test No.

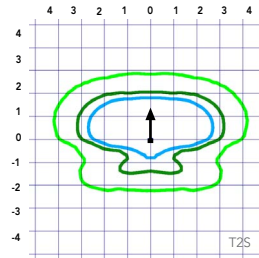

Test No. LTL23457P25 tested in accordance with IESNA LM-79-08.

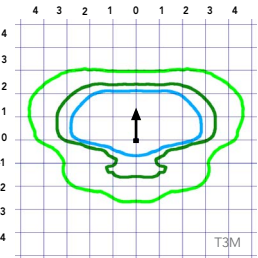

Test No. LTL23457P25 tested in accordance with IESNA LM-79-08.

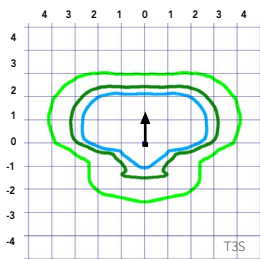

Test No. LTL23457P25 tested in accordance with IESNA LM-79-08.

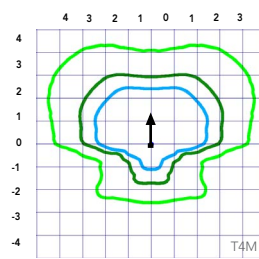

Test No.

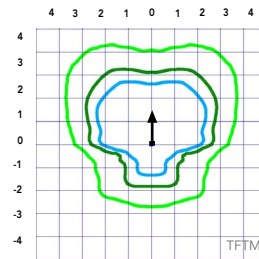

Test No.

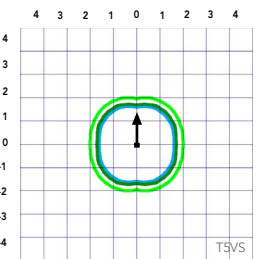

Test No.

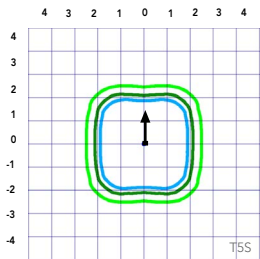

Test No.

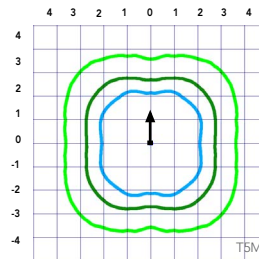

Test No.

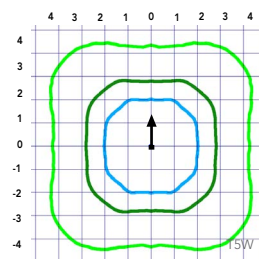

Test No. LTL23451P25 tested in accordance with IESNA LM-79-08.

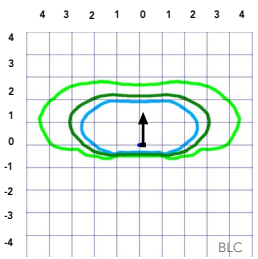

Test No.

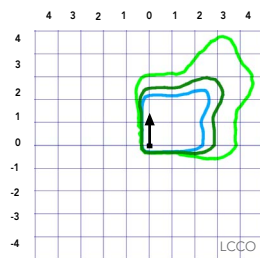

Test No.

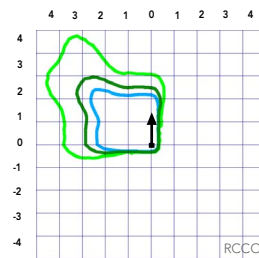

Test No.

Performance Data

Lumen Ambient Temperature (LAT) Multipliers

Use these factors to determine relative lumen output for average ambient temperatures from 0-40°C (32-104°F).

Ambient		Lumen Multiplier
0°C	32°F	1.04
5°C	41°F	1.04
10°C	50°F	1.03
15°C	59°F	1.02
20°C	68°F	1.01
25°C	77°C	1.00
30°C	86°F	0.99
35°C	95°F	0.98
40°C	104°F	0.97

Projected LED Lumen Maintenance

Data references the extrapolated performance projections for the platforms noted in a **25°C ambient**, based on 10,000 hours of LED testing (tested per IESNA LM-80-08 and projected per IESNA TM-21-11).

To calculate LLF, use the lumen maintenance factor that corresponds to the desired number of operating hours below. For other lumen maintenance values, contact factory.

Operating Hours	Lumen Maintenance Factor
25,000	0.96
50,000	0.92
100,000	0.85

Motion Sensor Default Settings						
Option	Dimmed State	High Level (when triggered)	Photocell Operation	Dwell Time	Ramp-up Time	Ramp-down Time
PIR or PIRH	3V (37%) Output	10V (100%) Output	Enabled @ 5FC	5 min	3 sec	5 min
*PIR1FC3V or PIRH1FC3V	3V (37%) Output	10V (100%) Output	Enabled @ 1FC	5 min	3 sec	5 min

*for use when motion sensor is used as dusk to dawn control.

Controls Options

Nomenclature	Description	Functionality	Primary control device	Notes
FAO	Field adjustable output device installed inside the luminaire; wired to the driver dimming leads.	Allows the luminaire to be manually dimmed, effectively trimming the light output.	FAO device	Cannot be used with other controls options that need the 0-10V leads
DS	Drivers wired independently for 50/50 luminaire operation	The luminaire is wired to two separate circuits, allowing for 50/50 operation.	Independently wired drivers	Requires two separately switched circuits. Consider nLight AIR as a more cost effective alternative.
PERS or PER7	Twist-lock photocell receptacle	Compatible with standard twist-lock photocells for dusk to dawn operation, or advanced control nodes that provide 0-10V dimming signals.	Twist-lock photocells such as DLL Elite or advanced control nodes such as ROAM.	Pins 4 & 5 to dimming leads on driver, Pins 6 & 7 are capped inside luminaire
PIR or PIRH	Motion sensors with integral photocell. PIR for 8-15' mounting; PIRH for 15-30' mounting	Luminaires dim when no occupancy is detected.	Acuity Controls SBGR	Also available with PIRH1FC3V when the sensor photocell is used for dusk-to-dawn operation.
NLTAIR2 PIRHN	nLight AIR enabled luminaire for motion sensing, photocell and wireless communication.	Motion and ambient light sensing with group response. Scheduled dimming with motion sensor over-ride when wirelessly connected to the nLight Eclipse.	nLight Air rSDGR	nLight AIR sensors can be programmed and commissioned from the ground using the CIAIRity Pro app.

Electrical Load

					Current (A)					
	Performance Package	LED Count	Drive Current	Wattage	120	208	240	277	347	480
Forward Optics (Non-Rotated)	P1	20	530	38	0.32	0.18	0.15	0.15	0.10	0.08
	P2	20	700	49	0.41	0.23	0.20	0.19	0.14	0.11
	P3	20	1050	71	0.60	0.37	0.32	0.27	0.21	0.15
	P4	20	1400	92	0.77	0.45	0.39	0.35	0.28	0.20
	P5	40	700	89	0.74	0.43	0.38	0.34	0.26	0.20
	P6	40	1050	134	1.13	0.65	0.55	0.48	0.39	0.29
	P7	40	1300	166	1.38	0.80	0.69	0.60	0.50	0.37
Rotated Optics (Requires L90 or R90)	P10	30	530	53	0.45	0.26	0.23	0.21	0.16	0.12
	P11	30	700	72	0.60	0.35	0.30	0.27	0.20	0.16
	P12	30	1050	104	0.88	0.50	0.44	0.39	0.31	0.23
	P13	30	1300	128	1.08	0.62	0.54	0.48	0.37	0.27

Performance Data

Lumen Output

Lumen values are from photometric tests performed in accordance with IESNA LM-79-08. Data is considered to be representative of the configurations shown, within the tolerances allowed by Lighting Facts. Contact factory for performance data on any configurations not shown here.

Forward Optics																			
Power Package	LED Count	Drive Current	System Watts	Dist. Type	30K (3000 K, 70 CRI)					40K (4000 K, 70 CRI)					50K (5000 K, 70 CRI)				
					Lumens	B	U	G	LPW	Lumens	B	U	G	LPW	Lumens	B	U	G	LPW
P1	20	530	38W	T1S	4,369	1	0	1	115	4,706	1	0	1	124	4,766	1	0	1	125
				T2S	4,387	1	0	1	115	4,726	1	0	1	124	4,785	1	0	1	126
				T2M	4,364	1	0	1	115	4,701	1	0	1	124	4,761	1	0	1	125
				T3S	4,376	1	0	1	115	4,714	1	0	1	124	4,774	1	0	1	126
				T3M	4,248	1	0	1	112	4,577	1	0	1	120	4,634	1	0	1	122
				T4M	4,281	1	0	1	113	4,612	1	0	2	121	4,670	1	0	2	123
				TFTM	4,373	1	0	1	115	4,711	1	0	2	124	4,771	1	0	2	126
				TSVS	4,548	2	0	0	120	4,900	2	0	0	129	4,962	2	0	0	131
				T5S	4,552	2	0	0	120	4,904	2	0	0	129	4,966	2	0	0	131
				T5M	4,541	3	0	1	120	4,891	3	0	1	129	4,953	3	0	1	130
				TSW	4,576	3	0	2	120	4,929	3	0	2	130	4,992	3	0	2	131
				BLC	3,586	1	0	1	94	3,863	1	0	1	102	3,912	1	0	1	103
				LCCO	2,668	1	0	1	70	2,874	1	0	2	76	2,911	1	0	2	77
				RCCO	2,668	1	0	1	70	2,874	1	0	2	76	2,911	1	0	2	77
P2	20	700	49W	T1S	5,570	1	0	1	114	6,001	1	0	1	122	6,077	2	0	2	124
				T2S	5,593	1	0	1	114	6,025	1	0	1	123	6,102	1	0	1	124
				T2M	5,564	1	0	2	114	5,994	1	0	2	122	6,070	2	0	2	125
				T3S	5,580	1	0	2	114	6,011	1	0	2	123	6,087	1	0	2	124
				T3M	5,417	1	0	2	111	5,835	1	0	2	119	5,909	2	0	2	121
				T4M	5,458	1	0	2	111	5,880	1	0	2	120	5,955	1	0	2	122
				TFTM	5,576	1	0	2	114	6,007	1	0	2	123	6,083	1	0	2	124
				TSVS	5,799	2	0	0	118	6,247	2	0	0	127	6,327	2	0	0	129
				T5S	5,804	2	0	0	118	6,252	2	0	0	128	6,332	2	0	1	129
				T5M	5,789	3	0	1	118	6,237	3	0	1	127	6,316	3	0	1	129
				TSW	5,834	3	0	2	119	6,285	3	0	2	128	6,364	3	0	2	130
				BLC	4,572	1	0	1	93	4,925	1	0	1	101	4,987	1	0	1	102
				LCCO	3,402	1	0	2	69	3,665	1	0	2	75	3,711	1	0	2	76
				RCCO	3,402	1	0	2	69	3,665	1	0	2	75	3,711	1	0	2	76
P3	20	1050	71W	T1S	7,833	2	0	2	110	8,438	2	0	2	119	8,545	2	0	2	120
				T2S	7,865	2	0	2	111	8,473	2	0	2	119	8,580	2	0	2	121
				T2M	7,825	2	0	2	110	8,429	2	0	2	119	8,536	2	0	2	120
				T3S	7,846	2	0	2	111	8,452	2	0	2	119	8,559	2	0	2	121
				T3M	7,617	2	0	2	107	8,205	2	0	2	116	8,309	2	0	2	117
				T4M	7,675	2	0	2	108	8,269	2	0	2	116	8,373	2	0	2	118
				TFTM	7,841	2	0	2	110	8,447	2	0	2	119	8,554	2	0	2	120
				TSVS	8,155	3	0	0	115	8,785	3	0	0	124	8,896	3	0	0	125
				T5S	8,162	3	0	1	115	8,792	3	0	1	124	8,904	3	0	1	125
				T5M	8,141	3	0	2	115	8,770	3	0	2	124	8,881	3	0	2	125
				TSW	8,204	3	0	2	116	8,838	4	0	2	124	8,950	4	0	2	126
				BLC	6,429	1	0	2	91	6,926	1	0	2	98	7,013	1	0	2	99
				LCCO	4,784	1	0	2	67	5,153	1	0	2	73	5,218	1	0	2	73
				RCCO	4,784	1	0	2	67	5,153	1	0	2	73	5,218	1	0	2	73
P4	20	1400	92W	T1S	9,791	2	0	2	106	10,547	2	0	2	115	10,681	2	0	2	116
				T2S	9,831	2	0	2	107	10,590	2	0	2	115	10,724	2	0	2	117
				T2M	9,780	2	0	2	106	10,536	2	0	2	115	10,669	2	0	2	116
				T3S	9,807	2	0	2	107	10,565	2	0	2	115	10,698	2	0	2	116
				T3M	9,521	2	0	2	103	10,256	2	0	2	111	10,386	2	0	2	113
				T4M	9,594	2	0	2	104	10,335	2	0	3	112	10,466	2	0	3	114
				TFTM	9,801	2	0	2	107	10,558	2	0	2	115	10,692	2	0	2	116
				TSVS	10,193	3	0	1	111	10,981	3	0	1	119	11,120	3	0	1	121
				T5S	10,201	3	0	1	111	10,990	3	0	1	119	11,129	3	0	1	121
				T5M	10,176	4	0	2	111	10,962	4	0	2	119	11,101	4	0	2	121
				TSW	10,254	4	0	3	111	11,047	4	0	3	120	11,186	4	0	3	122
				BLC	8,036	1	0	2	87	8,656	1	0	2	94	8,766	1	0	2	95
				LCCO	5,979	1	0	2	65	6,441	1	0	2	70	6,523	1	0	3	71
				RCCO	5,979	1	0	2	65	6,441	1	0	2	70	6,523	1	0	3	71

Performance Data

Lumen Output

Lumen values are from photometric tests performed in accordance with IESNA LM-79-08. Data is considered to be representative of the configurations shown, within the tolerances allowed by Lighting Facts. Contact factory for performance data on any configurations not shown here.

Forward Optics																			
Power Package	LED Count	Drive Current	System Watts	Dist. Type	30K (3000 K, 70 CRI)					40K (4000 K, 70 CRI)					50K (5000 K, 70 CRI)				
					Lumens	B	U	G	LPW	Lumens	B	U	G	LPW	Lumens	B	U	G	LPW
P5	40	700	89W	T1S	10,831	2	0	2	122	11,668	2	0	2	131	11,816	2	0	2	133
				T2S	10,876	2	0	2	122	11,716	2	0	2	132	11,864	2	0	2	133
				T2M	10,820	2	0	2	122	11,656	2	0	2	131	11,803	2	0	2	133
				T3S	10,849	2	0	2	122	11,687	2	0	2	131	11,835	2	0	2	133
				T3M	10,532	2	0	2	118	11,346	2	0	2	127	11,490	2	0	2	129
				T4M	10,613	2	0	3	119	11,434	2	0	3	128	11,578	2	0	3	130
				TFTM	10,842	2	0	2	122	11,680	2	0	2	131	11,828	2	0	2	133
				TSVS	11,276	3	0	1	127	12,148	3	0	1	136	12,302	3	0	1	138
				T5S	11,286	3	0	1	127	12,158	3	0	1	137	12,312	3	0	1	138
				T5M	11,257	4	0	2	126	12,127	4	0	2	136	12,280	4	0	2	138
				T5W	11,344	4	0	3	127	12,221	4	0	3	137	12,375	4	0	3	139
				BLC	8,890	1	0	2	100	9,576	1	0	2	108	9,698	1	0	2	109
				LCCO	6,615	1	0	3	74	7,126	1	0	3	80	7,216	1	0	3	81
				RCCO	6,615	1	0	3	74	7,126	1	0	3	80	7,216	1	0	3	81
P6	40	1050	134W	T1S	14,805	3	0	3	110	15,949	3	0	3	119	16,151	3	0	3	121
				T2S	14,865	3	0	3	111	16,014	3	0	3	120	16,217	3	0	3	121
				T2M	14,789	3	0	3	110	15,932	3	0	3	119	16,134	3	0	3	120
				T3S	14,829	2	0	3	111	15,975	3	0	3	119	16,177	3	0	3	121
				T3M	14,396	3	0	3	107	15,509	3	0	3	116	15,705	3	0	3	117
				T4M	14,507	2	0	3	108	15,628	3	0	3	117	15,826	3	0	3	118
				TFTM	14,820	2	0	3	111	15,965	3	0	3	119	16,167	3	0	3	121
				TSVS	15,413	4	0	1	115	16,604	4	0	1	124	16,815	4	0	1	125
				T5S	15,426	3	0	1	115	16,618	4	0	1	124	16,828	4	0	1	126
				T5M	15,387	4	0	2	115	16,576	4	0	2	124	16,786	4	0	2	125
				T5W	15,506	4	0	3	116	16,704	4	0	3	125	16,915	4	0	3	126
				BLC	12,151	1	0	2	91	13,090	1	0	2	98	13,255	1	0	2	99
				LCCO	9,041	1	0	3	67	9,740	1	0	3	73	9,863	1	0	3	74
				RCCO	9,041	1	0	3	67	9,740	1	0	3	73	9,863	1	0	3	74
P7	40	1300	166W	T1S	17,023	3	0	3	103	18,338	3	0	3	110	18,570	3	0	3	112
				T2S	17,092	3	0	3	103	18,413	3	0	3	111	18,646	3	0	3	112
				T2M	17,005	3	0	3	102	18,319	3	0	3	110	18,551	3	0	3	112
				T3S	17,051	3	0	3	103	18,369	3	0	3	111	18,601	3	0	3	112
				T3M	16,553	3	0	3	100	17,832	3	0	3	107	18,058	3	0	3	109
				T4M	16,681	3	0	3	100	17,969	3	0	3	108	18,197	3	0	3	110
				TFTM	17,040	3	0	3	103	18,357	3	0	4	111	18,590	3	0	4	112
				TSVS	17,723	4	0	1	107	19,092	4	0	1	115	19,334	4	0	1	116
				T5S	17,737	4	0	2	107	19,108	4	0	2	115	19,349	4	0	2	117
				T5M	17,692	4	0	2	107	19,059	4	0	2	115	19,301	4	0	2	116
				T5W	17,829	5	0	3	107	19,207	5	0	3	116	19,450	5	0	3	117
				BLC	13,971	2	0	2	84	15,051	2	0	2	91	15,241	2	0	2	92
				LCCO	10,396	1	0	3	63	11,199	1	0	3	67	11,341	1	0	3	68
				RCCO	10,396	1	0	3	63	11,199	1	0	3	67	11,341	1	0	3	68

Performance Data

Lumen Output

Lumen values are from photometric tests performed in accordance with IESNA LM-79-08. Data is considered to be representative of the configurations shown, within the tolerances allowed by Lighting Facts. Contact factory for performance data on any configurations not shown here.

Rotated Optics																			
Power Package	LED Count	Drive Current	System Watts	Dist. Type	30K (3000 K, 70 CRI)					40K (4000 K, 70 CRI)					50K (5000 K, 70 CRI)				
					Lumens	B	U	G	LPW	Lumens	B	U	G	LPW	Lumens	B	U	G	LPW
P10	30	530	53W	T1S	6,727	2	0	2	127	7,247	3	0	3	137	7,339	3	0	3	138
				T2S	6,809	3	0	3	128	7,336	3	0	3	138	7,428	3	0	3	140
				T2M	6,689	3	0	3	126	7,205	3	0	3	136	7,297	3	0	3	138
				T3S	6,805	3	0	3	128	7,331	3	0	3	138	7,424	3	0	3	140
				T3M	6,585	3	0	3	124	7,094	3	0	3	134	7,183	3	0	3	136
				T4M	6,677	3	0	3	126	7,193	3	0	3	136	7,284	3	0	3	137
				TFTM	6,850	3	0	3	129	7,379	3	0	3	139	7,472	3	0	3	141
				TSVS	6,898	3	0	0	130	7,431	3	0	0	140	7,525	3	0	0	142
				T5S	6,840	2	0	1	129	7,368	2	0	1	139	7,461	2	0	1	141
				T5M	6,838	3	0	1	129	7,366	3	0	2	139	7,460	3	0	2	141
				TSW	6,777	3	0	2	128	7,300	3	0	2	138	7,393	3	0	2	139
				BLC	5,626	2	0	2	106	6,060	2	0	2	114	6,137	2	0	2	116
				LCCO	4,018	1	0	2	76	4,328	1	0	2	82	4,383	1	0	2	83
				RCCO	4,013	3	0	3	76	4,323	3	0	3	82	4,377	3	0	3	83
				P11	30	700	72W	T1S	8,594	3	0	3	119	9,258	3	0	3	129	9,376
T2S	8,699	3	0					3	121	9,371	3	0	3	130	9,490	3	0	3	132
T2M	8,545	3	0					3	119	9,205	3	0	3	128	9,322	3	0	3	129
T3S	8,694	3	0					3	121	9,366	3	0	3	130	9,484	3	0	3	132
T3M	8,412	3	0					3	117	9,062	3	0	3	126	9,177	3	0	3	127
T4M	8,530	3	0					3	118	9,189	3	0	3	128	9,305	3	0	3	129
TFTM	8,750	3	0					3	122	9,427	3	0	3	131	9,546	3	0	3	133
TSVS	8,812	3	0					0	122	9,493	3	0	0	132	9,613	3	0	0	134
T5S	8,738	3	0					1	121	9,413	3	0	1	131	9,532	3	0	1	132
T5M	8,736	3	0					2	121	9,411	3	0	2	131	9,530	3	0	2	132
TSW	8,657	4	0					2	120	9,326	4	0	2	130	9,444	4	0	2	131
BLC	7,187	3	0					3	100	7,742	3	0	3	108	7,840	3	0	3	109
LCCO	5,133	1	0					2	71	5,529	1	0	2	77	5,599	1	0	2	78
RCCO	5,126	3	0					3	71	5,522	3	0	3	77	5,592	3	0	3	78
P12	30	1050	104W					T1S	12,149	3	0	3	117	13,088	3	0	3	126	13,253
				T2S	12,297	3	0	3	118	13,247	3	0	3	127	13,415	3	0	3	129
				T2M	12,079	4	0	4	116	13,012	4	0	4	125	13,177	4	0	4	127
				T3S	12,290	3	0	3	118	13,239	4	0	4	127	13,407	4	0	4	129
				T3M	11,891	4	0	4	114	12,810	4	0	4	123	12,972	4	0	4	125
				T4M	12,058	4	0	4	116	12,990	4	0	4	125	13,154	4	0	4	126
				TFTM	12,369	4	0	4	119	13,325	4	0	4	128	13,494	4	0	4	130
				TSVS	12,456	3	0	1	120	13,419	3	0	1	129	13,589	4	0	1	131
				T5S	12,351	3	0	1	119	13,306	3	0	1	128	13,474	3	0	1	130
				T5M	12,349	4	0	2	119	13,303	4	0	2	128	13,471	4	0	2	130
				TSW	12,238	4	0	3	118	13,183	4	0	3	127	13,350	4	0	3	128
				BLC	10,159	3	0	3	98	10,944	3	0	3	105	11,083	3	0	3	107
				LCCO	7,256	1	0	3	70	7,816	1	0	3	75	7,915	1	0	3	76
				RCCO	7,246	3	0	3	70	7,806	4	0	4	75	7,905	4	0	4	76
				P13	30	1300	128W	T1S	14,438	3	0	3	113	15,554	3	0	3	122	15,751
T2S	14,614	3	0					3	114	15,744	4	0	4	123	15,943	4	0	4	125
T2M	14,355	4	0					4	112	15,465	4	0	4	121	15,660	4	0	4	122
T3S	14,606	4	0					4	114	15,735	4	0	4	123	15,934	4	0	4	124
T3M	14,132	4	0					4	110	15,224	4	0	4	119	15,417	4	0	4	120
T4M	14,330	4	0					4	112	15,438	4	0	4	121	15,633	4	0	4	122
TFTM	14,701	4	0					4	115	15,836	4	0	4	124	16,037	4	0	4	125
TSVS	14,804	4	0					1	116	15,948	4	0	1	125	16,150	4	0	1	126
T5S	14,679	3	0					1	115	15,814	3	0	1	124	16,014	3	0	1	125
T5M	14,676	4	0					2	115	15,810	4	0	2	124	16,010	4	0	2	125
TSW	14,544	4	0					3	114	15,668	4	0	3	122	15,866	4	0	3	124
BLC	7919	3	0					3	62	8531	3	0	3	67	8639	3	0	3	67
LCCO	5145	1	0					2	40	5543	1	0	2	43	5613	1	0	2	44
RCCO	5139	3	0					3	40	5536	3	0	3	43	5606	3	0	3	44



FEATURES & SPECIFICATIONS

INTENDED USE

The sleek design of the D-Series Size 0 reflects the embedded high performance LED technology. It is ideal for many commercial and municipal applications, such as parking lots, plazas, campuses, and pedestrian areas.

CONSTRUCTION

Single-piece die-cast aluminum housing has integral heat sink fins to optimize thermal management through conductive and convective cooling. Modular design allows for ease of maintenance and future light engine upgrades. The LED driver is mounted in direct contact with the casting to promote low operating temperature and long life. Housing is completely sealed against moisture and environmental contaminants (IP65). Low EPA (0.95 ft²) for optimized pole wind loading.

FINISH

Exterior parts are protected by a zinc-infused Super Durable TGIC thermoset powder coat finish that provides superior resistance to corrosion and weathering. A tightly controlled multi-stage process ensures a minimum 3 mils thickness for a finish that can withstand extreme climate changes without cracking or peeling. Available in both textured and non-textured finishes.

OPTICS

Precision-molded proprietary acrylic lenses are engineered for superior area lighting distribution, uniformity, and pole spacing. Light engines are available in 3000 K, 4000 K or 5000 K (70 CRI) configurations. The D-Series Size 0 has zero uplight and qualifies as a Nighttime Friendly™ product, meaning it is consistent with the LEED® and Green Globes™ criteria for eliminating wasteful uplight.

ELECTRICAL

Light engine(s) configurations consist of high-efficacy LEDs mounted to metal-core circuit boards to maximize heat dissipation and promote long life (up to L85/100,000 hours at 25°C). Class 1 electronic drivers are designed to have a power factor >90%, THD <20%, and an expected life of 100,000 hours with <1% failure rate. Easily serviceable 10kV surge protection device meets a minimum Category C Low operation (per ANSI/IEEE C62.41.2).

STANDARD CONTROLS

The DSX0 LED area luminaire has a number of control options. DSX Size 0, comes standard with 0-10V dimming driver. Dusk to dawn controls can be utilized via optional NEMA twist-lock photocell receptacles. Integrated motion sensors with on-board photocells feature field-adjustable programming and are suitable for mounting heights up to 30 feet.

nLIGHT AIR CONTROLS

The DSX0 LED area luminaire is also available with nLight® AIR for the ultimate in wireless control. This powerful controls platform provides out-of-the-box basic motion sensing and photocontrol functionality and is suitable for mounting heights up to 40 feet. Once commissioned using a smartphone and the easy-to-use CLAIRITY app, nLight AIR equipped luminaires can be grouped, resulting in motion sensor and photocell group response without the need for additional equipment. Scheduled dimming with motion sensor over-ride can be achieved when used with the nLight Eclipse. Additional information about nLight Air can be found [here](#).

INSTALLATION

Included mounting block and integral arm facilitate quick and easy installation. Stainless steel bolts fasten the mounting block securely to poles and walls, enabling the D-Series Size 0 to withstand up to a 3.0 G vibration load rating per ANSI C136.31. The D-Series Size 0 utilizes the AERIS™ series pole drilling pattern (template #8). Optional terminal block and NEMA photocontrol receptacle are also available.

LISTINGS

UL listed to meet U.S. and Canadian standards. UL Listed for wet locations. Light engines are IP66 rated; luminaire is IP65 rated. Rated for -40°C to 50°C ambient with HA option. U.S. Patent No. D672,492 S. International patent pending.

DesignLights Consortium® (DLC) Premium qualified product and DLC qualified product. Not all versions of this product may be DLC Premium qualified or DLC qualified. Please check the DLC Qualified Products List at www.designlights.org/QPL to confirm which versions are qualified.

International Dark-Sky Association (IDA) Fixture Seal of Approval (FSA) is available for all products on this page utilizing 3000K color temperature only.

GOVERNMENT PROCUREMENT

BAA – Buy America(n) Act: Product with the BAA option qualifies as a domestic end product under the Buy American Act as implemented in the FAR and DFARS. Product with the BAA option also qualifies as manufactured in the United States under DOT Buy America regulations.

BABA – Build America Buy America: Product with the BAA option also qualifies as produced in the United States under the definitions of the Build America, Buy America Act.

Please refer to www.acuitybrands.com/buy-american for additional information.

WARRANTY

5-year limited warranty. This is the only warranty provided and no other statements in this specification sheet create any warranty of any kind. All other express and implied warranties are disclaimed. Complete warranty terms located at: www.acuitybrands.com/support/warranty/terms-and-conditions

Note: Actual performance may differ as a result of end-user environment and application.

All values are design or typical values, measured under laboratory conditions at 25 °C.

Specifications subject to change without notice.