



# SLOT 2

RECESSED  
TUNABLE WHITE  
DC2DC ARCHITECTURE

## HIGHLIGHTS

- 300 to 1000 lumens per foot Direct
- Two lens depths: OD (Flush) and 1D (1" Regress)
- 5 direct distributions: Lambertian, Batwing, Wall Wash, Wall Graze, or Asymmetric
- Multiple lens treatment options: Continuous Flush and Drop in 1/2", 1", or 1-1/2" depths
- Shielding provided by optional louver
- Driver option for Dim to Dark
- White, black or silver paint with satin finish
- UGR data available on page 4



## FIXTURE PERFORMANCE

Nominal Lumens/Foot	Direct*									
	300LMF		400LMF		600LMF		800LMF		1000LMF	
CCT	27K	65K	27K	65K	27K	65K	27K	65K	27K	65K
Delivered Lumens/Foot	280	287	380	383	580	576	780	769	979	962
DC Input Watts/Foot**	2.35	2.33	3.24	3.15	5.01	4.82	6.80	6.47	8.57	8.14
Lumens/Watt	119	123	117	121	116	120	115	119	114	118

\*Based on a 4FT 90CRI TUWH RHYR (27K-65K) fixture with OD lens depth, standard lambertian distribution, and Flush Lens (FLL). Consult factory for other section lengths.

\*\*Standard photometry based on AC wattage, DC wattage = AC wattage \*.93

**Note:** See Page 6 for Device Addresses and Feed details.



## DIRECT DISTRIBUTION

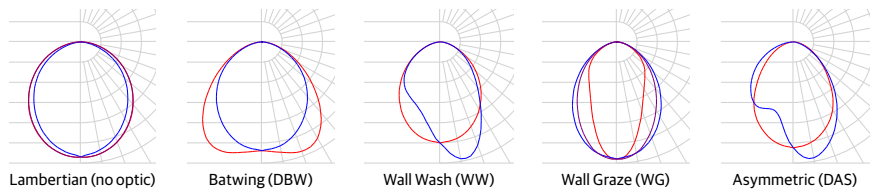

## DIMENSIONS

Section View

FL Trim with OD Lens Regress

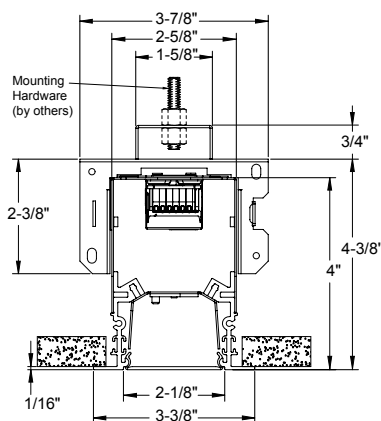

## DIFFUSERS/SHIELDING

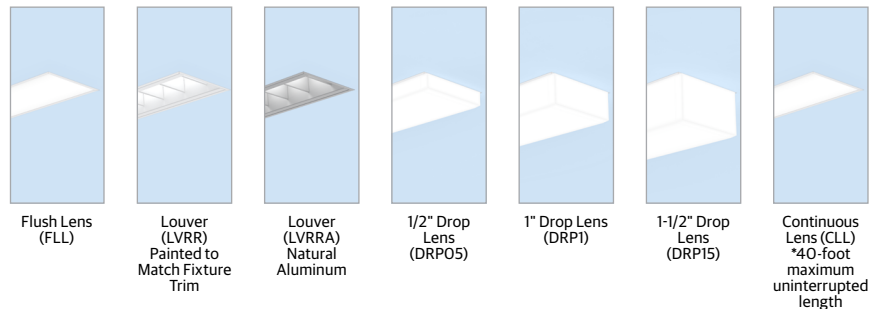

**ORDERING**

Example: S2RD LOP 18FT5.5 1D FL 9OCRI TUWH RHYP 1000LMF SCT DARK CLL 57VDC WHTT DAL18

--	--	--	--	--	--	--	--

Series	Linear Plan	Total Run Length	Lens Regress Depth	Ceiling Type	Direct Light Source Color Rendering	Direct Dynamic Feature
<b>S2RD</b> Slot 2 Recessed Direct	<b>LOP</b> Optimized Length	<b>.FT_</b> Specify continuous linear feet to nearest 1/8" increments starting at 2FT (Example: 24' - 6 1/8" = 24FT6.125) <b>.FT'</b> Specify continuous linear feet to whole foot increments starting at 2FT (Example: 24' = 24FT) Unit length may affect available options. <b>For runs longer than 8FT: ALWAYS order the run by the TOTAL RUN LENGTH. Ordering the sections individually will not provide the correct joining hardware to allow run connections in the field.</b> 1. Use whole foot increment when using DRPO5, DRP1, DRP15, LVRR, LVRRRA, or zoning options.	<b>OD</b> 0" Depth <b>1D</b> <sup>1,2,3</sup> 1" Depth 1. Available with FLL, CLL, LVRR, or LVRRRA Optional Shielding only. 2. Not available with Direct Distribution options. 3. Not available with FLINB or GBINB	<b>FL</b> 5/8IN Flange (sheetrock) <b>GB</b> Gypsum Board (sheetrock) <b>FLINB</b> 5/8IN Flange (sheetrock) Install From Below <b>GBINB</b> Gypsum Board (sheetrock) Install From Below <b>TG</b> Grid Ceiling: 9/16" Flat Tee with Lay-In Tile, 9/16" Flat Tee with Tegular Tile, 9/16" Slot Tee with Tegular Tile, 15/16" Flat Tee with Lay-In Tile, & 15/16" Flat Tee with Tegular Tile <b>FLW'</b> 5/8IN Flange (sheetrock) Wall Mounted <b>GBW'</b> Gypsum Board (sheetrock) Wall Mounted 1. When using FLW or GBW options, FLW will change to FL & GBW will change to GB for shipping lines to designate same fixture as ceiling mounted units. *For compatibility with metal pans, hardwood, or other ceiling types, consult technical support.	<b>9OCRI</b> 90CRI	<b>TUWH</b> Tunable White

--	--	--	--	--	--	--

Direct Dynamic Range	Direct LED Light Output	Direct Distribution <sup>1</sup>	Switching	Minimum Dimming Level	Optional Shielding
<b>RHYR</b> Rhythm Range (2700K-6500K)	<b>300LMF</b> 300 Lumens per Foot <b>400LMF</b> 400 Lumens per Foot <b>600LMF</b> 600 Lumens per Foot <b>800LMF</b> 800 Lumens per Foot <b>1000LMF</b> 1,000 Lumens per Foot <b>_LMF</b> Specify Lumens between 300LMF and 1000LMF in 50LMF increments.	<b>&lt;blank&gt;</b> Lambertian <b>DAS</b> Direct asymmetric distribution <b>DBW</b> Direct Batwing Distribution <b>WG</b> Wall Graze Distribution <b>WW</b> Wall Wash 1. Direct Distribution options are only available with FLL Direct Shielding and OD Lens Regress Depth option.	<b>SCT</b> Single Circuit	<b>DARK</b> Constant Current, Dimming to 0.1%	<b>CLL</b> <sup>3,6</sup> Continuous Flush Lens <b>DRPO5</b> <sup>1,2,5</sup> Drop Lens 1/2IN <b>DRP1</b> <sup>1,2,5</sup> Drop Lens 1IN <b>DRP15</b> <sup>1,2,5</sup> Drop Lens 1 1/2IN <b>FLL</b> <sup>4</sup> Flush Lens <b>LVRR</b> <sup>1,2</sup> Louver (painted same finish color as housing) <b>LVRRRA</b> <sup>1,2</sup> Natural Aluminum Louver 1. Not available with TG trim. 2. Only available in whole foot increments. 3. CLL is not available with WW, WG, DAS, or DBW distributions. 4. When using distribution options, FLL will change to FLLC to designate a co-extruded lens with white and clear material. 5. Not available with 1D Lens Regress Depth 6. 4-foot maximum uninterrupted length.

--	--	--	--	--	--

Voltage	Finish	Emergency Options	Control Input	Primary Zone	Secondary Zone
<b>57VDC</b> 57VDC, Class 2 Only	<b>WHTT</b> White (Satin) <b>AMF</b> Antimicrobial White <b>BLKT</b> Black (Satin) <b>SLVT</b> Silver (Satin) <b>RALTB D'</b> <a href="#">RAL Paint Finish</a> 1. RALTB D' is for pricing only. Replace with applicable RAL number & sheen when placing order	<b>&lt;blank&gt;</b> No Emergency Option <b>_EC</b> Total Number of Emergency Circuits	<b>DAL18</b> eldoLED Driver TW DT8	<b>&lt;blank&gt;</b> No Sensor or Primary Zone Option <b>NS_</b> Primary Zone with No Sensor (Specify zone length in feet.)	<b>&lt;blank&gt;</b> No Sensor or Secondary Zone Option <b>SNS_</b> Secondary Zone with No Sensor (Specify zone length in feet.)

--	--

Tertiary Zone Indicator	Options
<b>&lt;blank&gt;</b> No Tertiary Zone <b>TNS_</b> Tertiary Zone (Specify zone length in feet.)	<b>&lt;blank&gt;</b> No Options <b>CP</b> Chicago Plenum

## PHOTOMETRICS

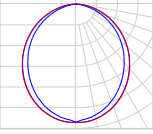
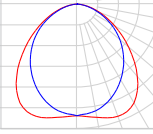
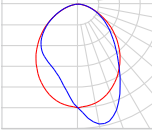
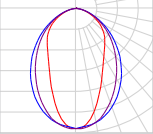
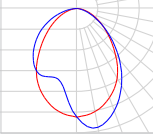
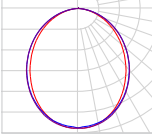
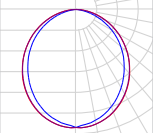
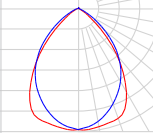
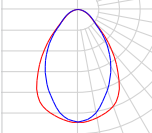
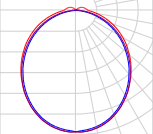
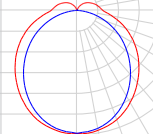
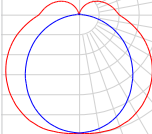
 <p>Test Report: ISF25 000625AP6644 IES LM79-08 Catalog #: S2RD 4FT OD 90CRI TUWH RHYS @46K 1000LMF STD FLL Lumens: 3650 DC Wattage: 28.89 Efficacy: 126.34</p>	 <p>Test Report: ISF25 000847P1014 IES LM79-08 Catalog #: S2RD 4FT OD 90CRI TUWH RHYS @46K 1000LMF DBW FLLC Lumens: 3260 DC Wattage: 28.89 Efficacy: 104.96</p>	 <p>Test Report: ISF25 000845AP1014 IES LM79-08 Catalog #: S2RD 4FT OD 90CRI TUWH RHYS @46K 1000LMF WW FLLC Lumens: 3020 DC Wattage: 28.89 Efficacy: 104.53</p>
 <p>Test Report: ISF25 000844P1769 IES LM79-08 Catalog #: S2RD 4FT OD 90CRI TUWH RHYS @46K 1000LMF WG FLLC Lumens: 2905 DC Wattage: 28.89 Efficacy: 100.55</p>	 <p>Test Report: ISF25 000846AP1771 IES LM79-08 Catalog #: S2RD 4FT OD 90CRI TUWH RHYS @46K 1000LMF DAS FLLC Lumens: 3536 DC Wattage: 28.89 Efficacy: 122.40</p>	 <p>Test Report: ISF25 000843P2747 IES LM79-08 Catalog #: S2RD 4FT OD 90CRI TUWH RHYS @46K 1000LMF STD CLL Lumens: 3625 DC Wattage: 28.89 Efficacy: 125.48</p>
 <p>Test Report: ISF25 000770P3859 IES LM79-08 Catalog #: S2RD 4FT 1D 90CRI TUWH RHYS @46K 1000LMF STD FLL Lumens: 3446 DC Wattage: 28.89 Efficacy: 119.28</p>	 <p>Test Report: ISF25 000848P2795 IES LM79-08 Catalog #: S2RD 4FT OD 90CRI TUWH RHYS @46K 1000LMF STD LVRRRA Lumens: 1366 DC Wattage: 28.89 Efficacy: 47.28</p>	 <p>Test Report: ISF25 000849P2726 IES LM79-08 Catalog #: S2RD 4FT OD 90CRI TUWH RHYS @46K 1000LMF STD LVRRRA Lumens: 1601 DC Wattage: 28.89 Efficacy: 55.42</p>
 <p>Test Report: ISF25 000840P1014 IES LM79-08 Catalog #: S2RD 4FT OD 90CRI TUWH RHYS @46K 1000LMF STD DRP05 Lumens: 3862 DC Wattage: 28.89 Efficacy: 133.68</p>	 <p>Test Report: ISF25 000841P1014 IES LM79-08 Catalog #: S2RD 4FT OD 90CRI TUWH RHYS @46K 1000LMF STD DRP1 Lumens: 3931 DC Wattage: 28.89 Efficacy: 136.07</p>	 <p>Test Report: ISF25 000842P1014 IES LM79-08 Catalog #: S2RD 4FT OD 90CRI TUWH RHYS @46K 1000LMF STD DRP15 Lumens: 3950 DC Wattage: 28.89 Efficacy: 136.73</p>

## PROJECT LED LUMEN MAINTENANCE

Data references the extrapolated performance projections for the platforms noted in a 25°C ambient, based on 10,000 hours of LED testing (tested per IESNA LM-80-08 and projected per IESNA TM-21-11). To calculate LLF, use the lumen maintenance factor that corresponds to the desired number of operating hours below. For other lumen maintenance values, contact factory.

Operating Hours	0	10,000	60,000	100,000
Lumen Maintenance Factor	1	0.98	0.84	0.75

## REGRESS DEPTH SCALING CHART

LENS REGRESS DEPTH	MULTIPLIER
OD	1.00
1D	0.94

\*Base fixture with Lambertian distribution, 0" depth lens regress (OD), and flush lens (FLL)

## OPTICAL SCALING CHARTS

DISTRIBUTIONS	MULTIPLIER
LAMBERTIAN	1.00
DBW	0.89
DAS	0.97
WW	0.83
WG	0.80
SHIELDING	MULTIPLIER
LVRR	0.44
LVRRRA	0.37
CLL	0.99
FLL	1.00
DRP05	1.06
DRP1	1.08
DRP15	1.08

\*Base fixture with Lambertian distribution and flush lens (FLL)

## 50LMF INCREMENT SCALING CHART

NOMINAL LMF	LUMEN	WATTAGE
	MULTIPLIER	MULTIPLIER
300LMF	0.31	0.30
350LMF	0.36	0.35
400LMF	0.41	0.40
450LMF	0.46	0.45
500LMF	0.52	0.50
550LMF	0.57	0.54
600LMF	0.62	0.59
650LMF	0.67	0.64
700LMF	0.72	0.69
750LMF	0.76	0.75
800LMF	0.81	0.80
850LMF	0.86	0.85
900LMF	0.91	0.90
950LMF	0.96	0.95
1000LMF	1.00	1.00

\*Base fixture with 0" depth lens regress (OD), standard lambertian distribution, flush lens (FLL), and 1000LMF

## TUNABLE WHITE GAMUT AND RANGE

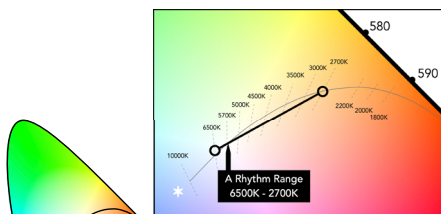

**A** Rhythm Range 6500K to 2700K

### Tunable White GPHD

- Gamut: One dimensional Warm-Cool (WC)
- Path: Single-segment 6500K to 2700K (Rhythm Range)
- Handle: Two natural language handles: Intensity and CCT
- Data: nLight with nTune technology for both handles of control

**UGR CHART**

Lumen Package	UGR (70% 50% 20% reflectance using a 4H x 8H room size)														
	Crosswise												Endwise		
	OD FLL Lambertian	OD CLL Lambertian	OD DBW	OD WW	OD WG	OD DAS	OD LVRR	OD LVRRRA	OD DRP05	OD DRP1	OD DRP15	1D FLL Lambertian	1D CLL Lambertian	1D LVRR	1D LVRRRA
300LMF	21.6	21.9	20.1	19.9	19.9	18.3	15.1	10.5	19.8	18	16.7	22.1	21.7	14.9	10.3
400LMF	22.6	22.9	21.1	20.9	20.9	19.3	16.1	11.5	20.8	19	17.7	23.1	22.7	15.9	11.3
600LMF	24	24.3	22.5	22.3	22.3	20.7	17.5	12.9	22.2	20.4	19.1	24.5	24.1	17.3	12.7
800LMF	25	25.3	23.5	23.2	23.3	21.7	18.4	13.8	23.2	21.4	20	25.4	25.1	18.2	13.6
1000LMF	25.7	26	24.2	23.9	24	22.4	19.2	14.5	23.9	22.1	20.7	26.1	25.8	19	14.3
Lumen Package	Endwise														
	OD FLL Lambertian	OD CLL Lambertian	OD DBW	OD WW	OD WG	OD DAS	OD LVRR	OD LVRRRA	OD DRP05	OD DRP1	OD DRP15	1D FLL Lambertian	1D CLL Lambertian	1D LVRR	1D LVRRRA
300LMF	22.5	21.2	20.8	20	19.1	20	14.4	5.2	22.7	23	23.1	19.5	21	14.2	5
400LMF	23.5	22.2	21.8	21	20.1	21	15.4	6.2	23.7	24	24.1	20.5	22	15.2	6
600LMF	24.9	23.6	23.2	22.4	21.5	22.4	16.8	7.6	25.1	25.4	25.5	21.9	23.4	16.6	7.4
800LMF	25.9	24.5	24.1	23.3	22.4	23.3	17.8	8.5	26	26.4	26.4	22.8	24.3	17.6	8.3
1000LMF	26.6	25.2	24.8	24.1	23.1	24	18.5	9.2	26.7	27.1	27.2	23.5	25	18.3	9

\*UGR varies based on luminaire options and is affected by application dependent parameters. Numbers depicted here are considered "Luminaire-UGR" and/or "Point-UGR" values. To determine a more precise maximum UGR value ("Application-UGR"), a full lighting design layout should be completed with the selected luminaire configuration for each application.

\*\*Click here for more information on: [UGR FAQ](#)

**CEILING TRIMS**

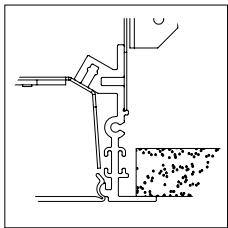

**FL**  
5/8IN Flange (sheetrock)  
Install Before Sheetrock

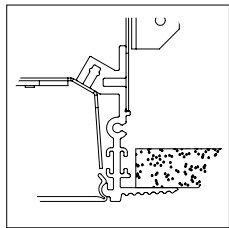

**GB**  
Gypsum Board (sheetrock)  
Install Before Sheetrock

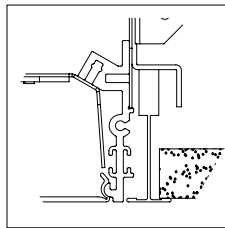

**TG**  
9/16" Flat Tee w/ Lay-in Tile

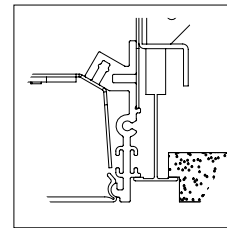

**TG**  
9/16" Flat Tee w/ Tegular Tile

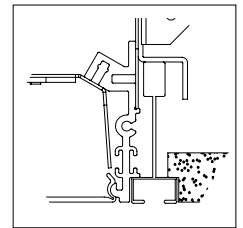

**TG**  
9/16" Slot Tee w/ Tegular Tile

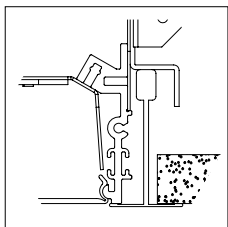

**TG**  
15/16" Flat Tee w/ Lay-in Tile

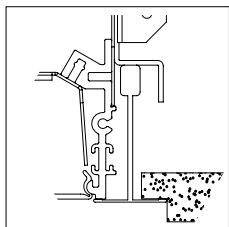

**TG**  
15/16" Flat Tee w/ Tegular Tile

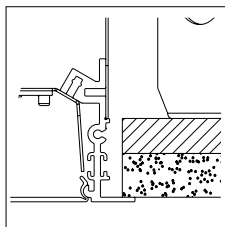

**FLINB**  
5/8IN Flange (sheetrock)  
Install From Below

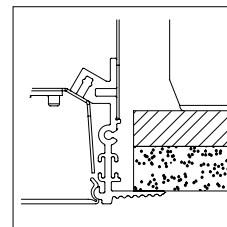

**GBINB**  
Gypsum Board (sheetrock)  
Install From Below

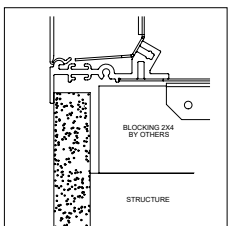

**FLW**  
5/8IN Flange (sheetrock)  
Wall Mounted

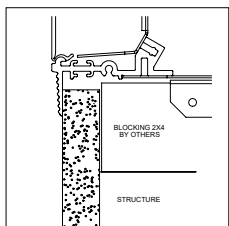

**GBW**  
Gypsum Board (sheetrock)  
Wall Mounted

\*For compatibility with metal pans, hardwood, or other ceiling types, consult technical support.

**LINEAR PLAN**

Mark Lighting calculates a continuous run based on optimizing fixture section length and options selected.

**LOP- Linear Optimized Length**

This linear plan supplies the run length based on defined length combinations, resulting in an optimized solution with the fewest segments.

LOP	8FT	4FT	3FT
-----	-----	-----	-----

**Total Run Length**

This system is not modular. Runs longer than 8FT will be automatically configured with left, intermediate, and right sections based on nomenclature ordered. Always order the total run length required and not individual sections.

Example: This run to be ordered as one 32FT run.

8FT	8FT	8FT	8FT
-----	-----	-----	-----

Example: This run to be ordered as four 8FT runs. Note: Individual fixtures sections cannot be joined together in the field.

8FT	8FT	8FT	8FT
-----	-----	-----	-----

**MOUNTING**

**FL and GB Trim Run**

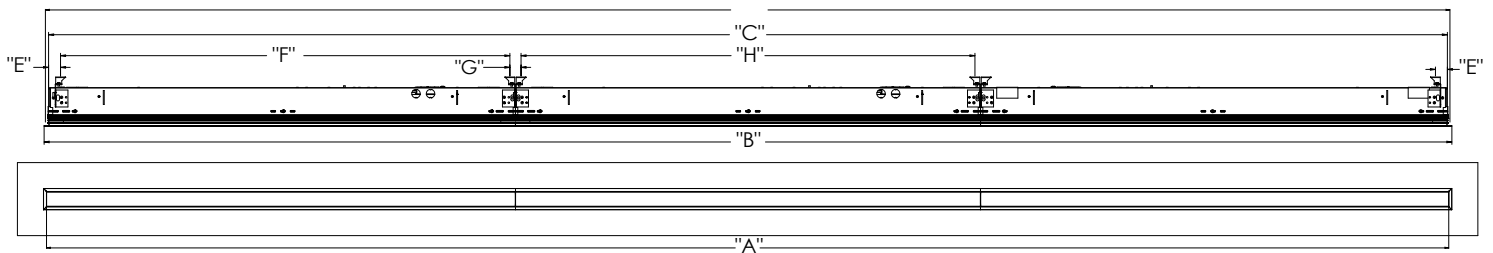

FL Run Configurations							
"A" (Illuminated Length)	"B" (Trim Length)	"C" (Housing Length)	"D" (Cut Opening Length)	"E" (End Mounting Location)	"F" (End Fixture Middle Mounting Point)	"G" (Mounting Point to Mounting Point)	"H" (Mounting Point to Mounting Point Intermediate Fixtures)
Order Length	Ordered Length + 15/16" (FL) + 113/16" (GB)	Order length + 9/16"	Order length + 13/16"	1 1/4"	Fixture length - 1 1/2"	1 1/16"	Fixture length - 1 1/16"

**TG Trim Run**

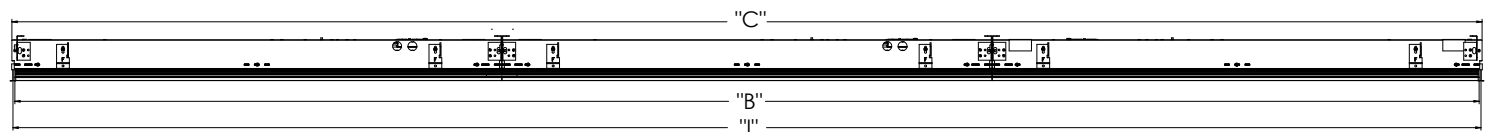

Grid Run Configurations			
"A" (Illuminated Length)	"B" (Trim Length)	"C" (Housing Length)	"I" (Grid Center to Center)
Order Length - 13/16"	Ordered Length - 5/8"	Order length - 1/32"	Order length + 13/16"

**MOUNTING (continued)**

**FLINB and GBINB Trim Run**

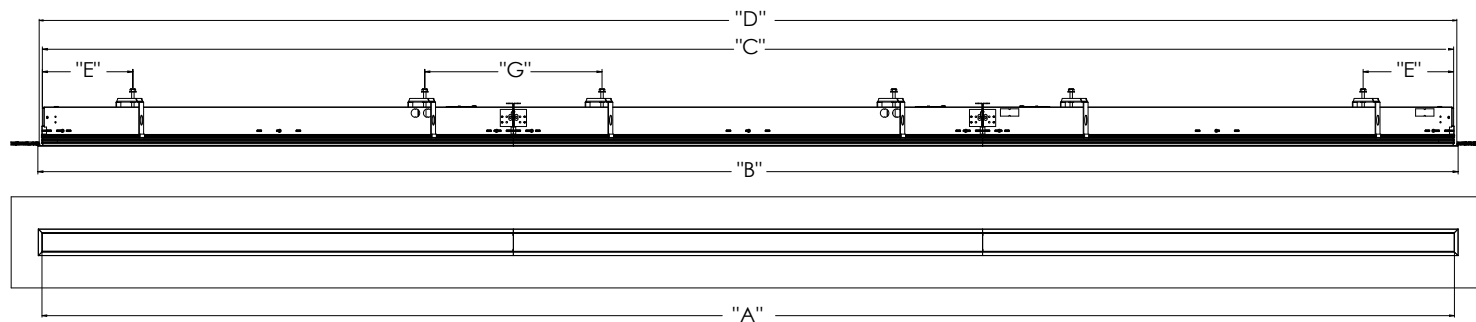

FL Run Configurations					
"A" (Illuminated Length)	"B" (Trim Length)	"C" (Housing Length)	"D" (Cut Opening Length)	"E" (End Mounting Location)	"G" (Mounting Point to Mounting Point)
Order Length	Order Length + 1 5/16"(FLINB) + 1 13/16"(GBINB)	Order length +9/16"	Order length +13/16"	6 1/4" 9 1/4"	1' 0 1/2" 1' 3 1/2" 1' 6 1/2"

**NOTE:** Dimension "E" depends on length (inconsistent across family). **NOTE:** Dimension "G" depends on fixture combination.

**Ceiling Cut Out Dimensions**

		2-Foot	3-Foot	4-Foot	5-Foot	6-Foot	7-Foot	8-Foot
TG	GRID CL LENGTH(IN)	24	36	48	60	72	84	96
	GRID CL WIDTH(IN)	3	3	3	3	3	3	3
FL or FLINB	LENGTH(IN)	24.813	36.813	48.81	60.813	72.813	84.81	96.813
	WIDTH(IN)	2.885	2.885	2.89	2.885	2.885	2.89	2.885
GB or GBINB	LENGTH(IN)	24.813	36.813	48.81	60.813	72.813	84.81	96.813
	WIDTH(IN)	2.885	2.885	2.89	2.885	2.885	2.89	2.885

CEILING OPENING DIMENSIONS FOR INSTALLATION, +/-0.13"

**MOUNTING (continued)**

**FIXTURE DIMENSIONS AND WEIGHTS**

		2-Foot	3-Foot	4-Foot	5-Foot	6-Foot	7-Foot	8-Foot	
		GRID CL (IN)	24	36	48	60	72	84	96
TG	Individual	OVERALL LENGTH (IN)	23.375	35.375	47.375	59.375	71.375	83.375	95.375
		HOUSING LENGTH (IN)	23.938	35.938	47.938	59.938	71.938	83.938	95.938
		APERTURE (IN)	23.125	35.125	47.125	59.125	71.125	83.128	95.125
	Left or Right	2-Foot							
		GRID CL (IN)	24	36	48	60	72	84	96
		PRODUCT LENGTH (IN)	23.688	35.688	47.688	59.688	71.688	83.688	95.688
		HOUSING LENGTH (IN)	23.938	35.938	47.938	59.938	71.938	83.938	95.938
	Intermediate	APERTURE (IN)	23.563	35.563	47.563	59.563	71.563	83.563	95.563
		2-Foot							
		GRID CL (IN)	24	36	48	60	72	84	96
	PRODUCT LENGTH (IN)	24	36	48	60	72	84	96	
	HOUSING LENGTH (IN)	23.938	35.938	47.938	59.938	71.938	83.938	95.938	
	APERTURE (IN)	24	36	48	60	72	84	96	

		2-Foot	3-Foot	4-Foot	5-Foot	6-Foot	7-Foot	8-Foot	
		APERTURE (IN)	24	36	48	60	72	84	96
FL or FLINB	Individual	PRODUCT LENGTH (IN)	25.250	37.250	49.250	61.250	73.250	85.250	97.250
		HOUSING LENGTH (IN)	24.563	36.563	48.563	60.563	72.563	84.563	96.563
	Left or Right	2-Foot							
		APERTURE (IN)	24	36	48	60	72	84	96
		PRODUCT LENGTH (IN)	24.625	36.625	48.625	60.625	72.625	84.625	96.625
	Intermediate	HOUSING LENGTH (IN)	24.250	36.250	48.250	60.250	72.250	84.250	96.250
		2-Foot							
		APERTURE (IN)	24	36	48	60	72	84	96
		PRODUCT LENGTH (IN)	24	36	48	60	72	84	96
		HOUSING LENGTH (IN)	23.938	35.938	47.938	59.938	71.938	83.938	95.938

		2-Foot	3-Foot	4-Foot	5-Foot	6-Foot	7-Foot	8-Foot	
		APERTURE (IN)	24	36	48	60	72	84	96
GB or GBINB		PRODUCT LENGTH (IN)	25.750	37.750	49.750	61.750	73.750	85.750	97.750
		HOUSING LENGTH (IN)	24.563	36.563	48.563	60.563	72.563	84.563	96.563
		APERTURE (IN)	24	36	48	60	72	84	96
		PRODUCT LENGTH (IN)	24.875	36.875	48.875	60.875	72.875	84.875	96.875
		HOUSING LENGTH (IN)	24.250	36.250	48.250	60.250	72.250	84.250	96.250
		2-Foot							
		APERTURE (IN)	24	36	48	60	72	84	96
		PRODUCT LENGTH (IN)	24	36	48	60	72	84	96
		HOUSING LENGTH (IN)	23.938	35.938	47.938	59.938	71.938	83.938	95.938

\*All values rounded to +/- 1/16"

Approximate Fixture Section Weights	2-Foot	3-Foot	4-Foot	5-Foot	6-Foot	7-Foot	8-Foot
	WEIGHT (LBS)	9	12	14	21	23	25

**DIRECT SHIELDING & OPTIONS**

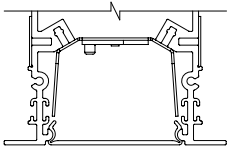

Flush Lens (FLL)  
Continuous Lens (CLL)

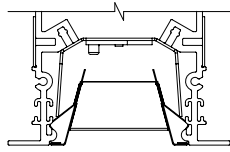

Louver (LVRRA)  
Aluminum Louver (LVRR) Painted

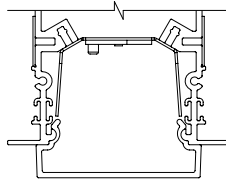

1/2" Drop Lens  
DRPO5

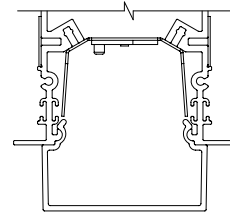

1" Drop Lens  
DRP1

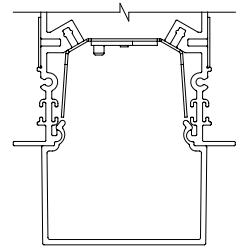

1-1/2" Drop Lens  
(DRP15)

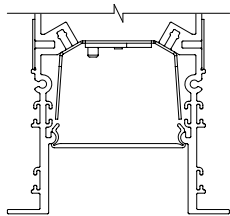

1" Regress with  
FLL or CLL

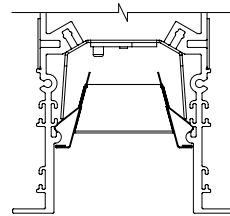

1" Regress with  
LVRRA or LVRR

**DIRECT DISTRIBUTION**

Optical Film for DAS, DBW, WG, and WW distributions with co-extruded lens standard.  
Direction of light for DAS or WG distribution will be in the direction of the notches on the film.

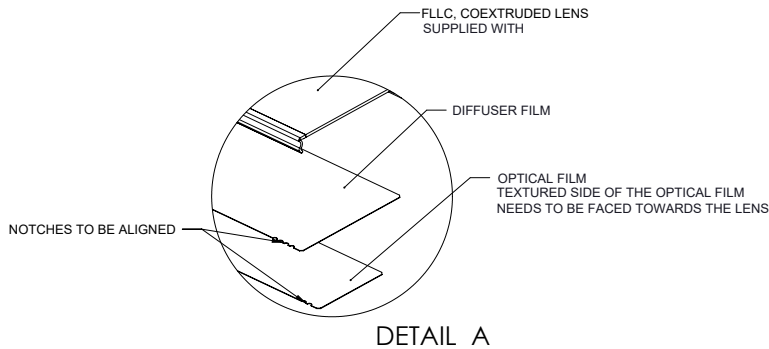
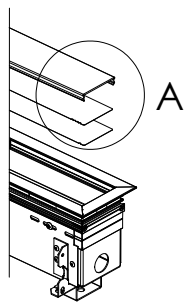

Optical Film	Number of Notches
Diffuser	4
Direct Asymmetric (DAS)	1
Direct Batwing (DBW)	2
Wall Graze (WG)	3
Wall Wash (WW)	5



When ordering distribution options, use FLL designation. FLL will automatically change to FLLC on shipped product, to designate this co-extruded lens with white and clear material.

**CONTINUOUS LENS**

40-foot maximum uninterrupted length. From 40-foot 1/8-inch to 106-foot, visible joiner required and supplied with lens rolls. Joiner will match color of trim. Continuous lens and joiners, if required, ship separate from the fixture. Reference installation instructions for further details and steps.

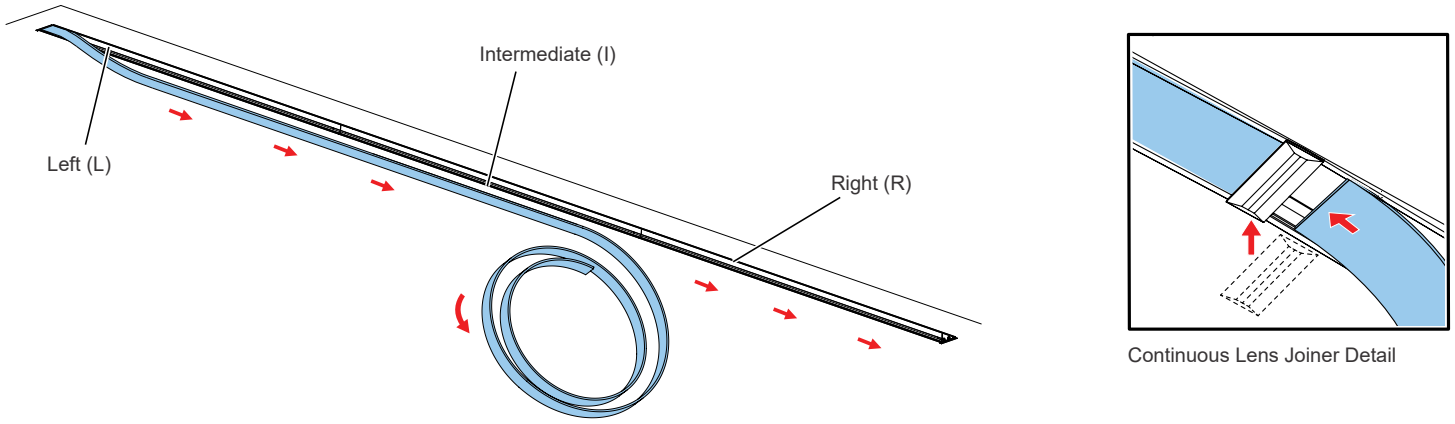

**RUN PATTERNS, CORNERS, & JUNCTIONS**

Patterns can be configured in 1' increments with illuminated L (corner), X, Y, & T connectors. Standard corner has 2' leg segments. Standard L (corner) connector angles are available in 40-179 degrees in 1 degree increments. Standard T & Y connector angles are available in 40-179 degrees in 1 degree increments. Standard X connector angle available in 40-90 degrees in 1 degree increments.

See separate pattern spec sheet for more details.

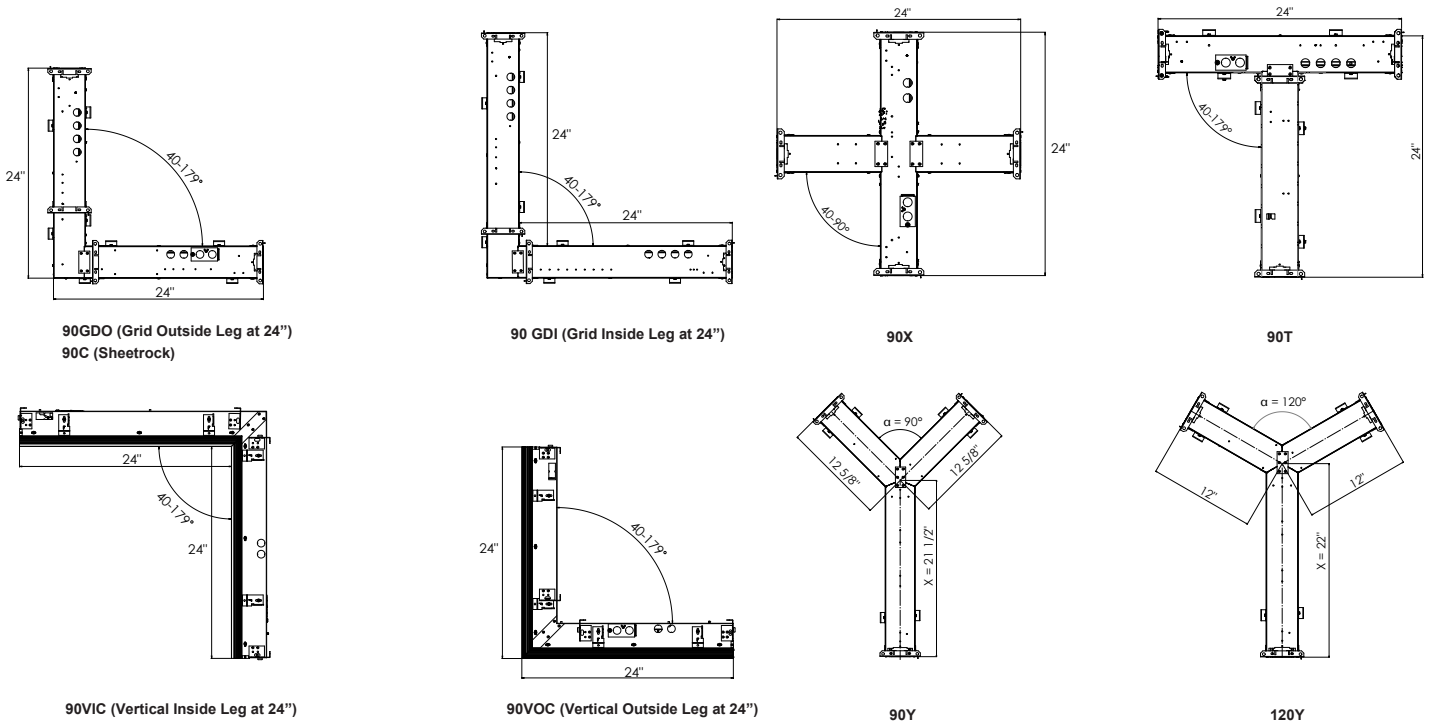

**NOTE:** For Y intersections, dimension X varies depending on the angle  $\alpha$ . Angle  $\alpha$  can be in a range of 40-179°.

**EMERGENCY OPTIONS**

**Emergency Circuits**

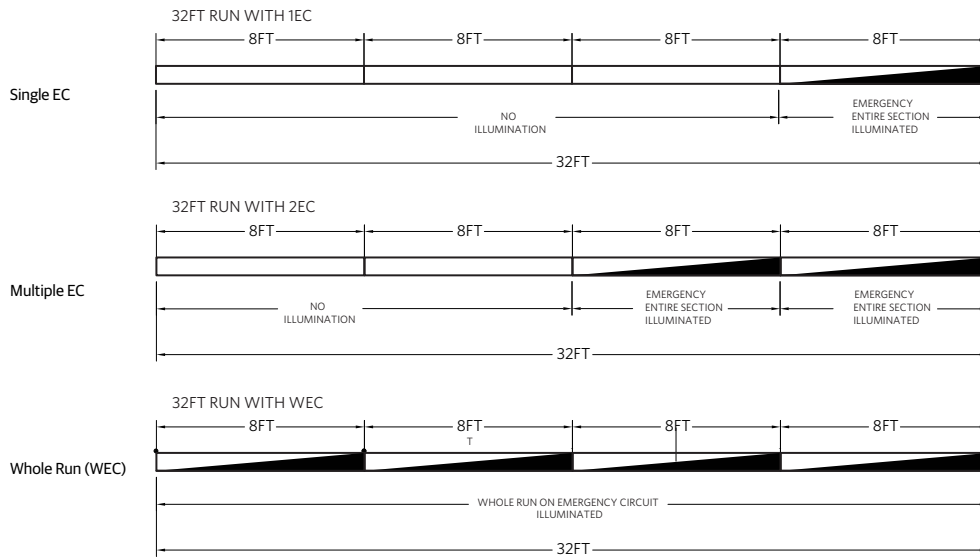

Control Input	
Section Length	EC
U2-U2/11.875	Entire Section Length
U3-U3/11.875	Entire Section Length
U4	Entire Section Length
U4/0.125-U4-11.875	Entire Section Length
U5-U5/11.875	Entire Section Length
U6-U6/11.875	Entire Section Length
U7-U7/11.875	Entire Section Length
U8	Entire Section Length

**INTELLIGENT LUMINAIRE GUIDE**

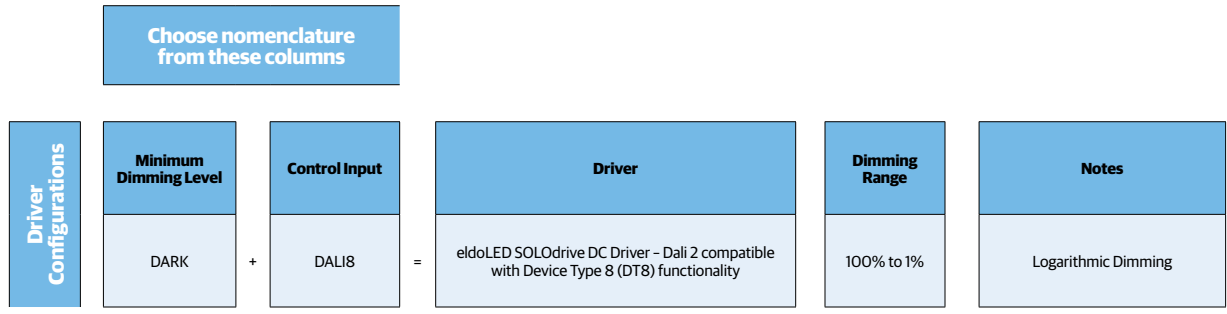

**DC2DC**

**DC-powered Lighting, DC2DC Architecture**

Acuity Brands' DC2DC architecture provides for distributed low-voltage DC power and digital controls for a range of LED luminaires, including the S2RD.

The DC2DC architecture enhances an LED lighting system's efficiency by eliminating the need and cost to convert AC to DC power at the luminaire and facilitating the installation and commissioning of lighting controls. Intrinsically more efficient by design, our DC-powered lighting architecture also delivers savings at design and installation, facilitates maintenance, and empowers lighting design focused on sustainable and well-being applications.

Components include:

- DCHUB (ordered separately), distributes DC power up to 1080 VA of DC-powered LED luminaires including support for emergency lighting.
- 57 VDC powered LED luminaires, with Static CCT or Tunable White, based on control options.
- nLight® lighting control
  - Integral or offboard wired networked lighting control, with nLight control devices (ordered separately).
  - Embedded nLight AIR wireless devices in 57VDC powered Static CCT LED luminaires.
- Class 2 power and control cables.
- The number of luminaires that can be supported by a single DCHUB port is a function of luminaire wattage and conductor losses. Please refer to the fixture wattages listed and the DCHUB spec sheet for additional details. Alternatively, the LED luminaires can be supplied with an approved, UL Listed, Class 2 power source supplying between 52.3 and 57.0 VDC at the input to the luminaire.

**Note:**

All luminaires require 57VDC option along with the corresponding Control Input option for DALI or DALI8 external nPS80 DALI 57VDC wired nLight control or NLTAIR2 or NLTAIREM2 embedded wireless lighting control.

When using external wired nLight control, nPS80 DALI 57 VDC is mounted locally with the controlled luminaires. Only 2 #16 AWG (min.) conductors are necessary between the DC power source and the nPS80 DALI controller, and 4 conductors between the controller and the luminaires.

When using nLight embedded wireless controls only 2 #16 AWG (min.) conductors are necessary between the DC power source and the luminaire runs.

Click [DC2DC](#) for more information.

**FIXTURE PERFORMANCE, DEVICE ADDRESSES, & FEED CHART<sup>1</sup>**

Nominal Lumens/Foot		Slot 2 Recessed Direct <sup>1</sup>									
		300LMF		400LMF		600LMF		800LMF		1000LMF	
CCT		27K	65K	27K	65K	27K	65K	27K	65K	27K	65K
<b>Delivered Lumens/Foot</b>		280	287	380	383	580	576	780	769	979	962
<b>DC Input Watts/Foot<sup>2</sup></b>		2.4	2.3	3.2	3.2	5.0	4.8	6.8	6.5	8.6	8.1
<b>Lumens/Watt</b>		119	123	117	121	116	120	115	119	114	118
<b># Device Addresses and Feeds</b>	<b>2FT</b>	1		1		1		1		1	
	<b>3FT</b>	1		1		1		1		1	
	<b>4FT</b>	1		1		1		1		1	
	<b>5FT<sup>3</sup></b>	2		2		2		2		2	
	<b>6FT<sup>4</sup></b>	2		2		2		2		2	
	<b>7FT<sup>5</sup></b>	2		2		2		2		2	
	<b>8FT<sup>4</sup></b>	2		2		2		2		2	

**Notes**

1. Based on a 4FT 90CRI TUWH RHYR (27K-65K) fixture with 0D lens depth, standard lambertian distribution, and Flush Lens (FLL). Consult factory for other section lengths.
2. Standard photometry based on AC wattage, DC wattage = AC wattage \* .93
3. For 5ft fixtures with two feeds, wattage for Feed 1 is 3/5 of the total wattage and for Feed 2 is 2/5 of the total wattage
4. For 6ft and 8ft fixtures with two feeds, wattage per feed is half of the total wattage
5. For 7ft fixtures with two feeds, wattage for Feed 1 is 4/7 of the total wattage and for Feed 2 is 3/7 of the total wattage

**General Note:** Combine feeds based on maximum port supply wattage or as shown on drawings. Refer to Mark Linear Submittal drawings for additional feed configuration information.

**Example Calculation:**

5FT 1000LMF

Total Direct Wattage: 8.6 W/FT x 5FT = 43W

Direct Feed 1: 3/5 x 43W = 25.8W

Direct Feed 2: 2/5 x 43W = 17.2W

## SPECIFICATIONS

### Housing

Nominal 2" x 2', 3', 4', 5', 6', 7', 8' and continuous rows in 1/8" increments starting at 2', as standard. Upper housing fabricated from cold-rolled steel with extruded aluminum ceiling trim.

### Finish

Standard colors for fixture trims are polyester powder coated white, anti-microbial white, black, or silver with satin sheen. Consult factory for custom colors or specify RAL colors from Architectural brochure.

### Reflector

Precision-formed steel; high reflectance matte white powder coat; 93% reflectivity.

### Optics (Distribution)

Wall Wash (WW), Wall Graze (WG), Direct Batwing (DBW), and Direct Asymmetric (DAS) incorporate co-extruded lenses and films.

### Lenses/Shielding

Extruded acrylic lens, (CLL, FLL). Aluminum louver with either a powder coat finish to match housing color (LVRR) or aluminum finish (LVRRA). Extruded acrylic drop lens (DRP05, DRP1, DRP15).

### Mounting

Sheetrock: Recessed ceiling only to accommodate sheetrock, 1/2" minimum to 1-1/2" maximum depth for FL, GB, FLINB or GBINB trim options. Grid: To accommodate 9/16" Flat Tee with Lay-In Tile, 9/16" Flat Tee with Tegular Tile, 9/16" Slot Tee with Tegular Tile, 15/16" Flat Tee with Lay-In Tile, & 15/16" Flat Tee with Tegular Tile.

### LED Source

Multiple lumen packages available in Rhythm Range (2700K-6500K) in 90CRI. The Acuity Brands circuit boards for the linear LED components use a precise binning algorithm which creates a consistent color temperature from board to board. Color variation of no greater than a 2.5 Step MacAdam (2.55DECM) along the black body locus from board to board.

### Electrical

Long-life LEDs, coupled with high-efficiency drivers, provide superior quantity and quality of illumination for extended service life. 90% LED lumen maintenance at 60,000 hours (L90/60,000).

### Circuits

Single switching option only.

### Dimming Driver

eldoLED constant current driver options deliver choice of dimming range for ultrasmooth dimming resolution from 100% to less than 1% , and choices for control, while assuring flicker free, low current inrush, 89% efficiency and low EMI. Luminaires operate over a voltage ranging from 53VDC to 57VDC.

### Ambient Operating Temperature Range

-20°C (-4° F) to +25°C (+77°F)

### Environment

Suitable for damp location. Indoor use only.

### Certification

CSA certified to meet U.S. and Canadian standards (UL1598 and UL8750). This product is IC rated.

### Fixture Weight

Approximately 4.0 lbs per foot, less packaging.

### Warranty

5-year limited warranty. This is the only warranty provided and no other statements in this specification sheet create any warranty of any kind. All other express and implied warranties are disclaimed. Complete warranty terms located at: [www.acuitybrands.com/support/warranty/terms-and-conditions](http://www.acuitybrands.com/support/warranty/terms-and-conditions)

**Notes:** Actual performance may differ as a result of end-user environment and application.

All values are design or typical values, measured under laboratory conditions at 25°C.

Specifications subject to change without notice