

SLOT 4

RECESSED
TUNABLE WHITE

HIGHLIGHTS

- 300 to 1500 lumens per foot Direct
- Two lens depths: OD (Flush) and 1D (1" Regress)
- 5 direct distributions: Lambertian, Batwing, Wall Wash, Wall Graze, or Asymmetric
- Multiple lens treatment options: Continuous Flush and Drop in 1/2", 1", or 1-1/2" depths
- Shielding provided by optional louver
- Mainstream Dynamic Tunable White with nTune™ Technology
- White, black or silver paint with satin finish
- UGR data available on page 4.

DIMENSIONS

Section View
FL Trim with OD Lens Regress

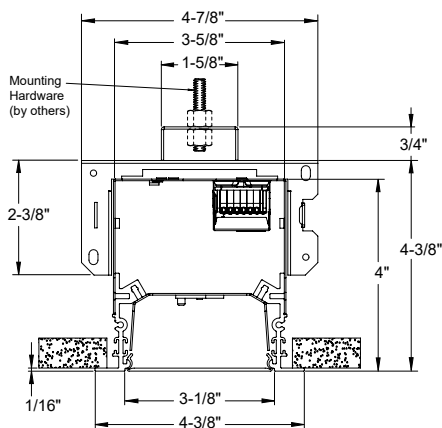

FIXTURE PERFORMANCE

Nominal Lumens/Foot	Direct											
	300LMF			400LMF			600LMF			800LMF		
CCT	27K	46K	65K	27K	46K	65K	27K	46K	65K	27K	46K	65K
Delivered Lumens/Foot	299	306	331	410	404	441	633	600	660	856	796	879
Input Watts/Foot	2.52	2.50	2.72	3.52	3.28	3.67	5.51	4.84	5.57	7.50	6.41	7.48
Lumens/Watt	119	122	122	116	123	120	115	124	118	114	124	118

Nominal Lumens/Foot	Direct								
	1000LMF			1200LMF			1300LMF		
CCT	27K	46K	65K	27K	46K	65K	27K	46K	65K
Delivered Lumens/Foot	1043	1001	1068	1176	1144	1197	1243	1215	1261
Input Watts/Foot	9.20	8.01	9.13	10.84	9.36	10.62	11.66	10.03	11.36
Lumens/Watt	113	125	117	108	122	113	107	121	111

Based on a 4FT 90CRI TUWH RHYR (27K-65K) fixture with 0" depth lens regress (OD), standard lambertian distribution, and flush lens (FLL)



DIRECT DISTRIBUTION

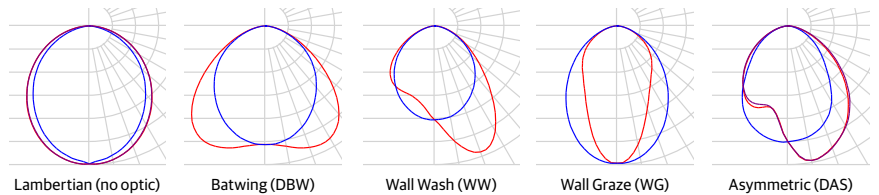

DIFFUSERS/SHIELDING

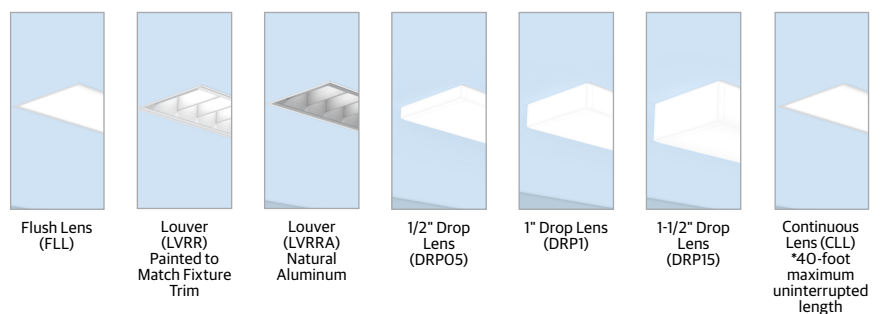

ORDERING

Example: S4RD LLP 32FT7.875 1D GB 1D 90CRI TUWH RHYP 800LMF SCT DARK CLL MVOLT WHTT 2EC NLT

Series	Linear Plan	Total Run Length	Lens Regress Depth	Ceiling Type	Direct Light Source Color Rendering	Direct Dynamic Feature
S4RD Slot 4 Recessed Direct	LOP Optimized Length	_FT_ Specify continuous linear feet to nearest 1/8" increments starting at 2FT (Example 24' - 6 1/8" = 24FT6.125) _FT' Specify continuous linear feet to whole foot increments starting at 2FT (Example: 24' = 24FT) Unit length may affect available options. For runs longer than 8FT: ALWAYS order the run by the TOTAL RUN LENGTH. Ordering the sections individually will not provide the correct joining hardware to allow run connections in the field. 1. Use whole foot increment when using DRPO5, DRP1, DRP15, LVRRA, LVRRA, sensors, or zoning options.	OD 0" Depth 1D^{1,2,3} 1" Depth 1. Available with FLL, CLL, LVRRA, or LVRRA Optional Shielding only. 2. Not available with Direct Distribution options. 3. Not available with FLINB or GBINB	FL 5/8IN Flange (sheetrock) GB Gypsum Board (sheetrock) FLINB 5/8IN Flange (sheetrock) Install From Below GBINB Gypsum Board (sheetrock) Install From Below TG Grid Ceiling: 9/16" Flat Tee with Lay-In Tile, 9/16" Flat Tee with Tegular Tile, 9/16" Slot Tee with Tegular Tile, 15/16" Flat Tee with Lay-In Tile, & 15/16" Flat Tee with Tegular Tile FLW¹ 5/8IN Flange (sheetrock) Wall Mounted GBW¹ Gypsum Board (sheetrock) Wall Mounted 1. When using FLW or GBW options, FLW will change to FL & GBW will change to GB for shipping lines to designate same fixture as ceiling mounted units. *For compatibility with metal pans, hardware, or other ceiling types, consult technical support.	90CRI 90CRI	TUWH Tunable White

Direct Dynamic Range	Direct LED Light Output	Direct Distribution ¹	Switching	Minimum Dimming Level	Optional Shielding
RHYR Rhythm Range (2700K-6500K)	300LMF 300 Lumens per Foot 400LMF 400 Lumens per Foot 600LMF 600 Lumens per Foot 800LMF 800 Lumens per Foot 1000LMF 1,000 Lumens per Foot 1200LMF 1,200 Lumens per Foot 1300LMF 1300 Lumens per Foot _LMF Specify Lumens between 300LMF and 1300LMF in 50LMF increments	<blank> Lambertian DAS Direct asymmetric distribution DBW Direct Batwing Distribution WG Wall Graze Distribution WW Wall Wash 1. Direct Distribution options are only available with FLL Direct Shielding and OD Lens Regress Depth option.	SCT Single Circuit	DARK Constant Current, Dimming to 0.1%	CLL^{3,6} Continuous Flush Lens DRPO5^{1,2,5} Drop Lens 1/2IN DRP1^{1,2,5} Drop Lens 1IN DRP15^{1,2,5} Drop Lens 1 1/2IN FLL⁴ Flush Lens LVRRA^{1,2} Louver (painted same finish color as housing) LVRRA^{1,2} Natural Aluminum Louver 1. Not available with TG trim, sensors, or emergency options E10WLCP or GTD. 2. Only available in whole foot increments. 3. CLL is not available with WW, WG, DAS, or DBW distributions. 4. When using distribution options, FLL will change to FLLC to designate a co-extruded lens with white and clear material. 5. Not available with 1D Lens Regress Depth 6. 40-foot maximum uninterrupted length.

Voltage	Finish	Emergency Battery Packs	Control Input	Primary Sensor or Zone ^{1,2}
MVOLT 120-277V 120¹ 120V 277¹ 277V 1. Required with GTD option.	WHTT White (Satin) AMF Antimicrobial White BLKT Black (Satin) SLVT Silver (Satin) RALTBDD¹ RAL Paint Finish 1. RALTBDD is for pricing only. Replace with applicable RAL number & sheen when placing order	<blank> No Emergency Option _E10WLCP^{1,3} Total Number of 10W Battery Packs, Constant Power, Self Diagnostic, T20 Compliant _RE10WLCP Total Number of Remote 10W Battery Packs, Constant Power, Self Diagnostics, T20 Compliant _EC Total Number of Emergency Circuits GTD² Generic Transfer Device 1. E10WLCP is not available in units 2' to 3'-11-7/8", 4'-0-1/8" to 4-11-7/8", or with 1D, LVRRA, LVRRA, DRPO5, DRP1, or DRP15 options. 2. GTD is remote mounted, not available with DRPO5, DRP1, DRP15, or CP options, and requires 120 or 277 voltage specified. 3. Available with maximum 1000LMF for complete linear run.	NLT nLight nTune Device	<blank> No Sensor or Primary Zone Option NS_ Primary Zone with No Sensor (Specify zone length in feet.) ADC_ Daylight Dimming Sensor with Primary Zone Length (Specify zone length in feet.) PDT_ Dual Technology Occupancy Sensor, PIR and Microphonics Sensor with Primary Zone Length (Specify zone length in feet.) APIR_ Passive Infrared Occupancy and Daylight Dimming Sensor (Specify total zone length in feet.) APDT_ Dual Technology Occupancy and Daylight Dimming Sensor (Specify total zone length in feet.) 1. Sensors are only available with OD and FLL or CLL options. 2. Available with FLINB & GBINB in maximum 1000LMF.

Secondary Sensor or Zone ^{1,2}	Tertiary Zone Indicator	Options
<blank> No Sensor or Secondary Zone Option SNS_ Secondary Zone with No Sensor (Specify zone length in feet.) SADC_ Daylight Dimming Sensor with Secondary Zone Length (Specify zone length in feet.) SPDT_ Dual Technology Occupancy Sensor, PIR and Microphonics Sensor with Secondary Zone Length (Specify zone length in feet.) SAPIR_ Passive Infrared Occupancy and Daylight Dimming Sensor (Specify total zone length in feet.) SAPDT_ Dual Technology Occupancy and Daylight Dimming Sensor (Specify total zone length in feet.) 1. Sensors are only available with OD and FLL or CLL options. 2. Available with FLINB & GBINB in maximum 1000LMF.	<blank> No Tertiary Zone TNS_ Tertiary Zone (Specify zone length in feet.)	<blank> No Options WL^{1,2,3,4} Wet Location CP Chicago Plenum BAA Buy America(n) Act and/or Build America Buy America Qualified 1. Lens is not sealed or gasketed. 2. Not available for vertical surface installation. 3. Available as individual fixture sections, starting at 2FT through 8FT maximum run length. 4. Not available with E10WLCP.

PHOTOMETRICS

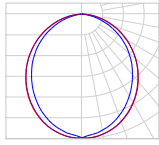

Test Report: ISF25 000625AP7606
IES LM79-08
Catalog #: S4RD 4FT OD 90CRI TUWH RHYP @46K 1000LMF STD FLL
Lumens: 4005
Wattage: 32.03
Efficacy: 125.04

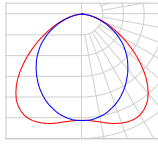

Test Report: ISF25 001020P1205
IES LM79-08
Catalog #: S4RD 4FT OD 90CRI TUWH RHYP @46K 1000LMF DBW FLLC
Lumens: 3984
Wattage: 32.03
Efficacy: 124.38

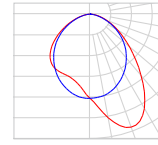

Test Report: ISF25 000818P1205
IES LM79-08
Catalog #: S4RD 4FT OD 90CRI TUWH RHYP @46K 1000LMF WW FLLC
Lumens: 3691
Wattage: 32.03
Efficacy: 115.24

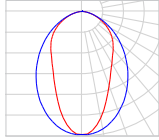

Test Report: ISF25 000817P2120
IES LM79-08
Catalog #: S4RD 4FT OD 90CRI TUWH RHYP @46K 1000LMF WG FLLC
Lumens: 3457
Wattage: 32.03
Efficacy: 107.93

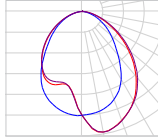

Test Report: ISF25 000819P2120
IES LM79-08
Catalog #: S4RD 4FT OD 90CRI TUWH RHYP @46K 1000LMF DAS FLLC
Lumens: 4354
Wattage: 32.03
Efficacy: 135.94

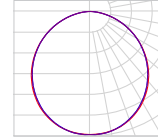

Test Report: ISF25 000816P3245
IES LM79-08
Catalog #: S4RD 4FT OD 90CRI TUWH RHYP @46K 1000LMF STD CLL
Lumens: 3970
Wattage: 32.03
Efficacy: 123.95

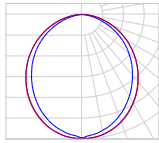

Test Report: ISF25 000770P4839
IES LM79-08
Catalog #: S4RD 4FT 1D 90CRI TUWH RHYP @46K 1000LMF STD FLL
Lumens: 3782
Wattage: 32.03
Efficacy: 118.08

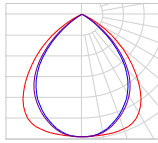

Test Report: ISF25 000822AP2370
IES LM79-08
Catalog #: S4RD 4FT OD 90CRI TUWH RHYP @46K 1000LMF STD LVRR
Lumens: 2138
Wattage: 32.03
Efficacy: 66.75

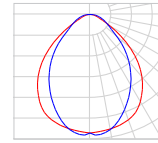

Test Report: ISF25 000821AP2370
IES LM79-08
Catalog #: S4RD 4FT OD 90CRI TUWH RHYP @46K 1000LMF STD LVRR
Lumens: 2249
Wattage: 32.03
Efficacy: 70.22

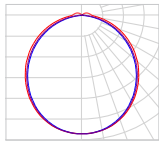

Test Report: ISF25 000813P1205
IES LM79-08
Catalog #: S4RD 4FT OD 90CRI TUWH RHYP @46K 1000LMF STD DRP05
Lumens: 4432
Wattage: 32.03
Efficacy: 138.37

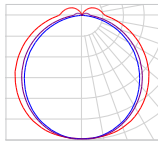

Test Report: ISF25 000814P1205
IES LM79-08
Catalog #: S4RD 4FT OD 90CRI TUWH RHYP @46K 1000LMF STD DRP1
Lumens: 4470
Wattage: 32.03
Efficacy: 139.56

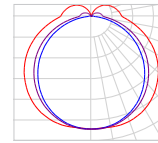

Test Report: ISF25 000815P1205
IES LM79-08
Catalog #: S4RD 4FT OD 90CRI TUWH RHYP @46K 1000LMF STD DRP15
Lumens: 4240
Wattage: 32.03
Efficacy: 132.38

PROJECT LED LUMEN MAINTENANCE

Data references the extrapolated performance projections for the platforms noted in a 25°C ambient, based on 10,000 hours of LED testing (tested per IESNA LM-80-08 and projected per IESNA TM-21-11).
To calculate LLF, use the lumen maintenance factor that corresponds to the desired number of operating hours below. For other lumen maintenance values, contact factory.

Operating Hours	0	10,000	60,000	100,000
Lumen Maintenance Factor	1	0.98	0.84	0.75

REGRESS DEPTH SCALING CHART

LENS REGRESS DEPTH	MULTIPLIER
OD	1.00
1D	0.94

*Base fixture with Lambertian distribution, 0" depth lens regress (OD), and flush lens (FLL)

OPTICAL SCALING CHARTS

DISTRIBUTIONS	MULTIPLIER
LAMBERTIAN	1.00
DBW	0.99
DAS	1.09
WW	0.92
WG	0.86
SHIELDING	MULTIPLIER
LVRR	0.56
LVRRA	0.53
CLL	0.99
FLL	1.00
DRP05	1.11
DRP1	1.12
DRP15	1.06

*Base fixture with Lambertian distribution and flush lens (FLL)

50LMF INCREMENT SCALING CHART

NOMINAL LMF	LUMEN	WATTAGE
	MULTIPLIER	MULTIPLIER
300LMF	0.31	0.30
350LMF	0.36	0.35
400LMF	0.41	0.40
450LMF	0.46	0.45
500LMF	0.52	0.50
550LMF	0.57	0.54
600LMF	0.62	0.59
650LMF	0.67	0.64
700LMF	0.72	0.69
750LMF	0.76	0.75
800LMF	0.81	0.80
850LMF	0.86	0.85
900LMF	0.91	0.90
950LMF	0.96	0.95
1000LMF	1.00	1.00
1050LMF	1.06	1.05
1100LMF	1.11	1.10
1150LMF	1.16	1.17
1200LMF	1.21	1.24
1250LMF	1.25	1.30
1300LMF	1.30	1.37

*Base fixture with 0" depth lens regress (OD), standard lambertian distribution, flush lens (FLL), and 1000LMF

TUNABLE WHITE GAMUT AND RANGE

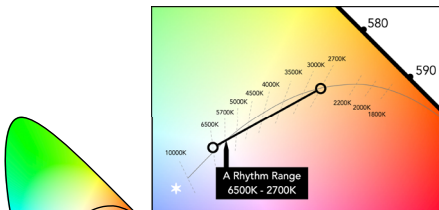

A Rhythm Range 6500K to 2700K

- Tunable White GPHD**
- Gamut: One dimensional Warm-Cool (WC)
 - Path: Single-segment 6500K to 2700K (Rhythm Range)
 - Handle: Two natural language handles: Intensity and CCT
 - Data: nLight with nTune technology for both handles of control

UGR CHART

Lumen Package	UGR (70% 50% 20% reflectance using a 4H x 8H room size)														
	Crosswise														
	OD FLL Lambertian	OD CLL Lambertian	OD DBW	OD WW	OD WG	OD DAS	OD LVRR	OD LVRRRA	OD DRP05	OD DRP1	OD DRP15	1D FLL Lambertian	1D CLL Lambertian	1D LVRR	1D LVRRRA
300LMF	20.7	21.4	19.6	19.3	19.3	18.9	15.7	7.5	19.5	18	16.4	20.5	21.2	15.5	7.3
400LMF	21.7	22.4	20.6	20.3	20.3	19.9	16.6	8.5	20.5	19	17.4	21.5	22.2	16.4	8.3
600LMF	23.1	23.8	22	21.7	21.7	21.3	18.1	9.9	21.9	20.4	18.8	22.9	23.6	17.9	9.7
800LMF	24.1	24.7	22.9	22.7	22.7	22.3	19	10.8	22.8	21.3	19.8	23.9	24.5	18.8	10.6
1000LMF	24.8	25.4	23.7	23.4	23.4	23	19.7	11.5	23.6	22	20.5	24.6	25.2	19.5	11.3
1200LMF	25.4	26.1	24.3	24	24.1	23.6	20.4	12.2	24.2	22.7	21.1	25.2	25.9	20.2	12
1300LMF	25.9	26.6	24.8	24.5	24.6	24.1	20.9	12.7	24.7	23.2	21.6	25.7	26.4	20.7	12.5
Lumen Package	Endwise														
	OD FLL Lambertian	OD CLL Lambertian	OD DBW	OD WW	OD WG	OD DAS	OD LVRR	OD LVRRRA	OD DRP05	OD DRP1	OD DRP15	1D FLL Lambertian	1D CLL Lambertian	1D LVRR	1D LVRRRA
	300LMF	21.6	21.4	20.2	20	18.8	21	15.2	11.8	21.6	22.1	22	21.4	21.2	15
400LMF	22.6	22.4	21.2	21	19.8	21.9	16.2	12.8	22.6	23.1	23	22.4	22.2	16	12.6
600LMF	24	23.8	22.6	22.4	21.2	23.4	17.6	14.2	24	24.5	24.4	23.8	23.6	17.4	14
800LMF	25	24.8	23.6	23.3	22.2	24.3	18.5	15.2	25	25.5	25.3	24.8	24.6	18.3	15
1000LMF	25.7	25.5	24.3	24.1	22.9	25	19.3	15.9	25.7	26.2	26.1	25.5	25.3	19.1	15.7
1200LMF	26.3	26.2	25	24.7	23.5	25.7	19.9	16.5	26.4	26.8	26.7	26.1	26	19.7	16.3
1300LMF	26.8	26.6	25.5	25.2	24	26.2	20.4	17	26.9	27.3	27.2	26.6	26.4	20.2	16.8

*UGR varies based on luminaire options and is affected by application dependent parameters. Numbers depicted here are considered "Luminaire-UGR" and/or "Point-UGR" values. To determine a more precise maximum UGR value ("Application-UGR"), a full lighting design layout should be completed with the selected luminaire configuration for each application.

**Click here for more information on: [UGR FAQ](#)

CEILING TRIMS

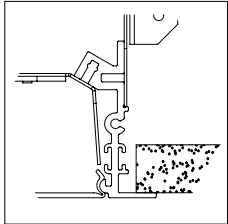

FL
5/8IN Flange (sheetrock)
Install Before Sheetrock

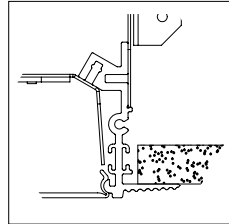

GB
Gypsum Board (sheetrock)
Install Before Sheetrock

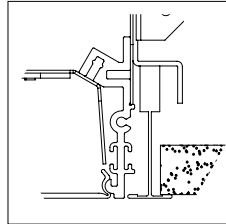

TG
9/16" Flat Tee w/ Lay-in Tile

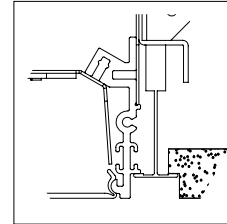

TG
9/16" Flat Tee w/ Tegular Tile

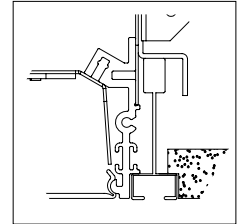

TG
9/16" Slot Tee w/ Tegular Tile

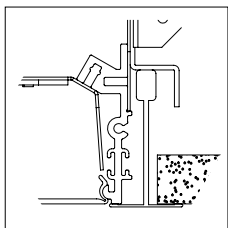

TG
15/16" Flat Tee w/ Lay-in Tile

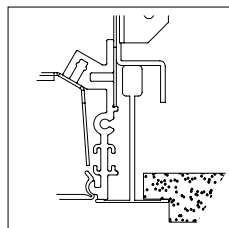

TG
15/16" Flat Tee w/ Tegular Tile

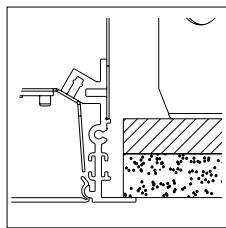

FLINB
5/8IN Flange (sheetrock)
Install From Below

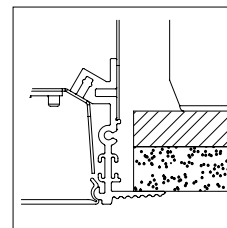

GBINB
Gypsum Board (sheetrock)
Install From Below

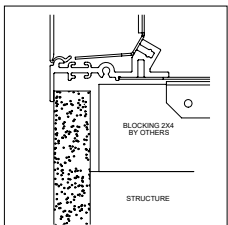

FLW
5/8IN Flange (sheetrock)
Wall Mounted

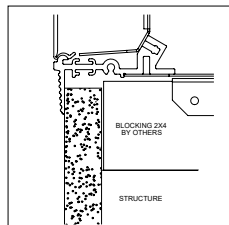

GBW
Gypsum Board (sheetrock)
Wall Mounted

*For compatibility with metal pans, hardwood, or other ceiling types, consult technical support.
*TG ceiling trim types are compatible with Armstrong 4" TECHZONE ceiling grid.

LINEAR PLAN

Mark Lighting calculates a continuous run based on optimizing fixture section length and options selected.

LOP- Linear Optimized Length

This linear plan supplies the run length based on defined length combinations, resulting in an optimized solution with the fewest segments. LOP

8FT	4FT	3FT
-----	-----	-----

Total Run Length

This system is not modular. Runs longer than 8FT will be automatically configured with left, intermediate, and right sections based on nomenclature ordered. Always order the total run length required and not individual sections.

Example: This run to be ordered as one 32FT run.

8FT	8FT	8FT	8FT
-----	-----	-----	-----

Example: This run to be ordered as four 8FT runs. Note: Individual fixtures sections cannot be joined together in the field.

8FT	8FT	8FT	8FT
-----	-----	-----	-----

MOUNTING

FL and GB Trim Run

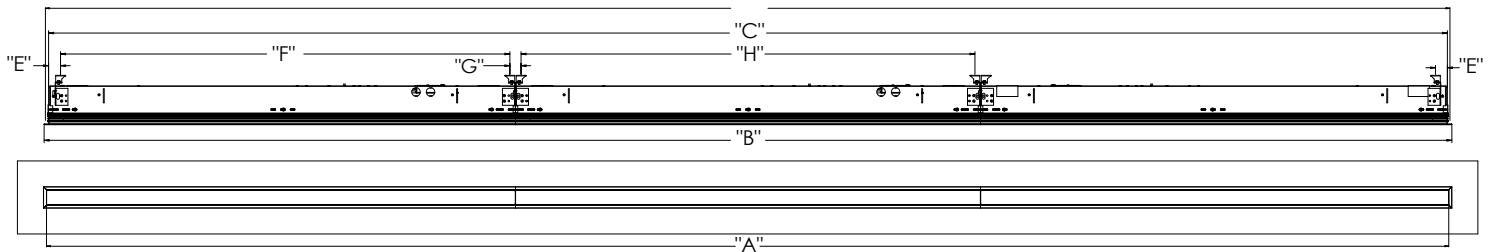

FL Run Configurations							
"A" (Illuminated Length)	"B" (Trim Length)	"C" (Housing Length)	"D" (Cut Opening Length)	"E" (End Mounting Location)	"F" (End Fixture Middle Mounting Point)	"G" (Mounting Point to Mounting Point)	"H" (Mounting Point to Mounting Point Intermediate Fixtures)
Order Length	Ordered Length + 15/16" (FL) + 113/16" (GB)	Order length + 9/16"	Order length + 13/16"	1 1/4"	Fixture length - 1 1/2"	1 1/16"	Fixture length - 1 1/16"

TG Trim Run

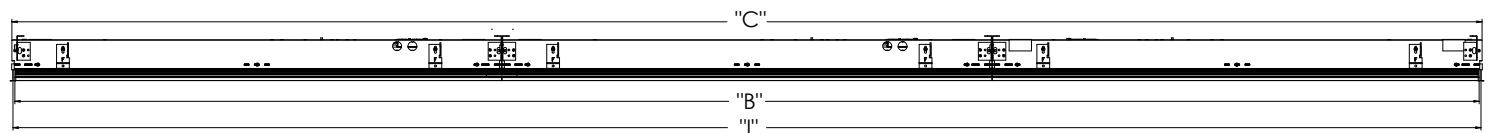

Grid Run Configurations			
"A" (Illuminated Length)	"B" (Trim Length)	"C" (Housing Length)	"I" (Grid Center to Center)
Order Length - 13/16"	Ordered Length - 5/8"	Order length - 1/32"	Order length + 13/16"

MOUNTING (continued)

FLINB and GBINB Trim Run

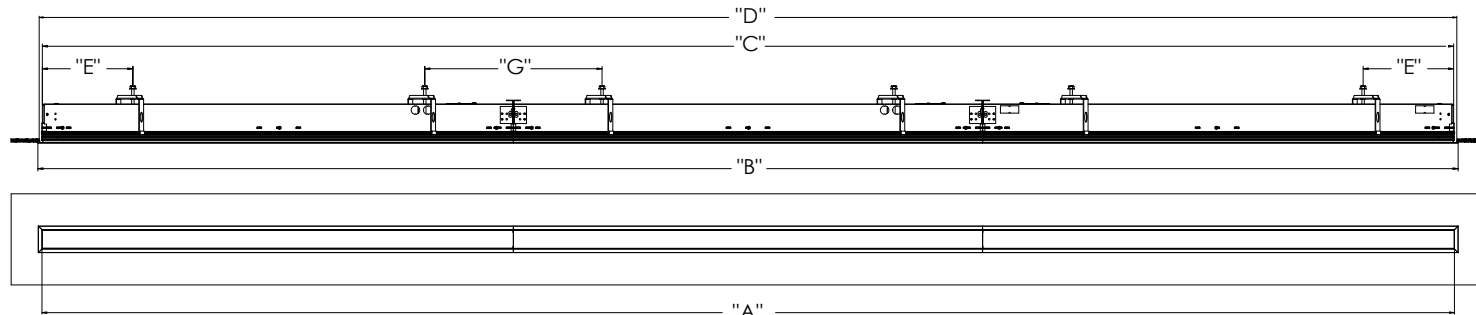

FL Run Configurations					
"A" (Illuminated Length)	"B" (Trim Length)	"C" (Housing Length)	"D" (Cut Opening Length)	"E" (End Mounting Location)	"G" (Mounting Point to Mounting Point)
Order Length	Order Length + 1 5/16"(FLINB) + 1 13/16"(GBINB)	Order length +9/16"	Order length +13/16"	6 1/4" 9 1/4"	1' 0 1/2" 1' 3 1/2" 1' 6 1/2"

NOTE: Dimension "E" depends on length (inconsistent across family). **NOTE:** Dimension "G" depends on fixture combination.

Ceiling Cut Out Dimensions

		2-Foot	3-Foot	4-Foot	5-Foot	6-Foot	7-Foot	8-Foot
TG	GRID CL LENGTH(IN)	24	36	48	60	72	84	96
	GRID CL WIDTH(IN)	4	4	4	4	4	4	4
FL or FLINB	LENGTH(IN)	24.813	36.813	48.81	60.813	72.813	84.81	96.813
	WIDTH(IN)	3.885	3.885	3.89	3.885	3.885	3.89	3.885
GB or GBINB	LENGTH(IN)	24.813	36.813	48.81	60.813	72.813	84.81	96.813
	WIDTH(IN)	3.885	3.885	3.89	3.885	3.885	3.89	3.885

CEILING OPENING DIMENSIONS FOR INSTALLATION, +/-0.13"

MOUNTING (continued)

FIXTURE DIMENSIONS AND WEIGHTS

		2-Foot	3-Foot	4-Foot	5-Foot	6-Foot	7-Foot	8-Foot	
		Individual	GRID CL (IN)	24	36	48	60	72	84
TG	Individual	OVERALL LENGTH (IN)	23.375	35.375	47.375	59.375	71.375	83.375	95.375
		HOUSING LENGTH (IN)	23.938	35.938	47.938	59.938	71.938	83.938	95.938
		APERTURE (IN)	23.125	35.125	47.125	59.125	71.125	83.128	95.125
	Left or Right	2-Foot							
		GRID CL (IN)	24	36	48	60	72	84	96
		PRODUCT LENGTH (IN)	23.688	35.688	47.688	59.688	71.688	83.688	95.688
		HOUSING LENGTH (IN)	23.938	35.938	47.938	59.938	71.938	83.938	95.938
	Intermediate	2-Foot							
		GRID CL (IN)	24	36	48	60	72	84	96
		PRODUCT LENGTH (IN)	24	36	48	60	72	84	96
		HOUSING LENGTH (IN)	23.938	35.938	47.938	59.938	71.938	83.938	95.938

		2-Foot	3-Foot	4-Foot	5-Foot	6-Foot	7-Foot	8-Foot	
		Individual	APERTURE (IN)	24	36	48	60	72	84
FL or FLINB	Individual	PRODUCT LENGTH (IN)	25.250	37.250	49.250	61.250	73.250	85.250	97.250
		HOUSING LENGTH (IN)	24.563	36.563	48.563	60.563	72.563	84.563	96.563
	Left or Right	2-Foot							
		APERTURE (IN)	24	36	48	60	72	84	96
		PRODUCT LENGTH (IN)	24.625	36.625	48.625	60.625	72.625	84.625	96.625
	Intermediate	2-Foot							
		HOUSING LENGTH (IN)	24.250	36.250	48.250	60.250	72.250	84.250	96.250

		2-Foot	3-Foot	4-Foot	5-Foot	6-Foot	7-Foot	8-Foot	
		GB or GBINB	Individual	APERTURE (IN)	24	36	48	60	72
PRODUCT LENGTH (IN)	25.750			37.750	49.750	61.750	73.750	85.750	97.750
HOUSING LENGTH (IN)	24.563			36.563	48.563	60.563	72.563	84.563	96.563
Left or Right	2-Foot								
	APERTURE (IN)		24	36	48	60	72	84	96
	PRODUCT LENGTH (IN)		24.875	36.875	48.875	60.875	72.875	84.875	96.875
Intermediate	2-Foot								
	HOUSING LENGTH (IN)		24.250	36.250	48.250	60.250	72.250	84.250	96.250

*All values rounded to +/- 1/16"

Approximate Fixture Section Weights	2-Foot	3-Foot	4-Foot	5-Foot	6-Foot	7-Foot	8-Foot
	WEIGHT (LBS)	10	13	15	22	25	28

DIRECT SHIELDING & OPTIONS

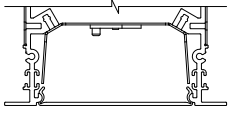

Flush Lens (FLL)
Continuous Lens (CLL)

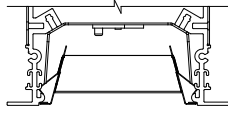

Louver (LVRRA)
Aluminum Louver
(LVRR) Painted

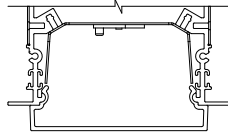

1/2" Drop Lens
DRP05

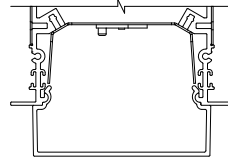

1" Drop Lens
DRP1

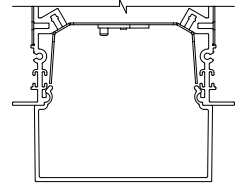

1-1/2" Drop Lens
(DRP15)

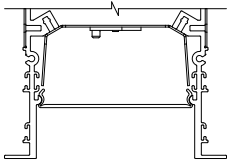

1" Regress with
FLL or CLL

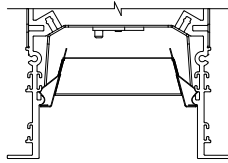

1" Regress with
LVRRA or LVRR

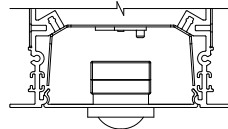

Sensor

DIRECT DISTRIBUTION

Optical Film for DAS, DBW, WG, and WW distributions with co-extruded lens standard.
Direction of light for DAS or WG distribution will be in the direction of the notches on the film.

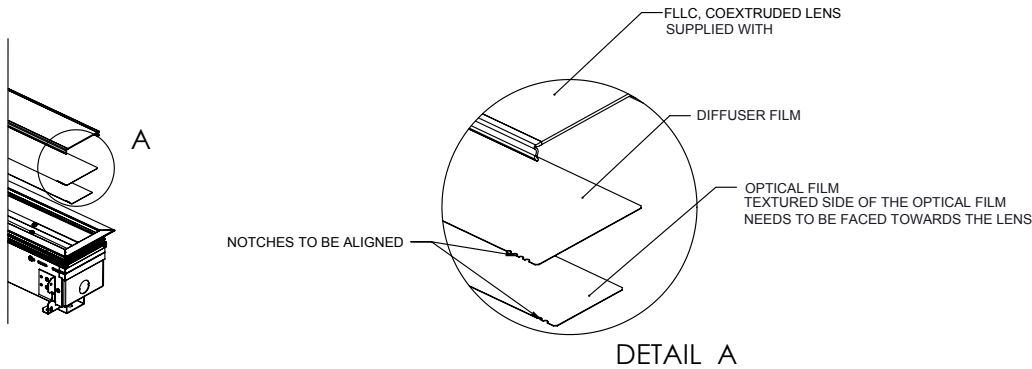

Optical Film	Number of Notches
Diffuser	4
Direct Asymmetric (DAS)	1
Direct Batwing (DBW)	2
Wall Graze (WG)	3
Wall Wash (WW)	5

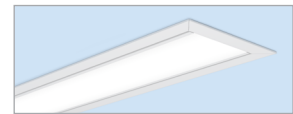

When ordering distribution options, use FLL designation. FLL will automatically change to FLLC on shipped product, to designate this co-extruded lens with white and clear material.

CONTINUOUS LENS

40-foot maximum uninterrupted length. From 40-foot 1/8-inch to 106-foot, visible joiner required and supplied with lens rolls. Joiner will match color of trim. Continuous lens and joiners, if required, ship separate from the fixture. Reference installation instructions for further details and steps.

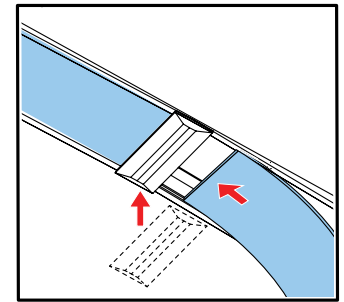
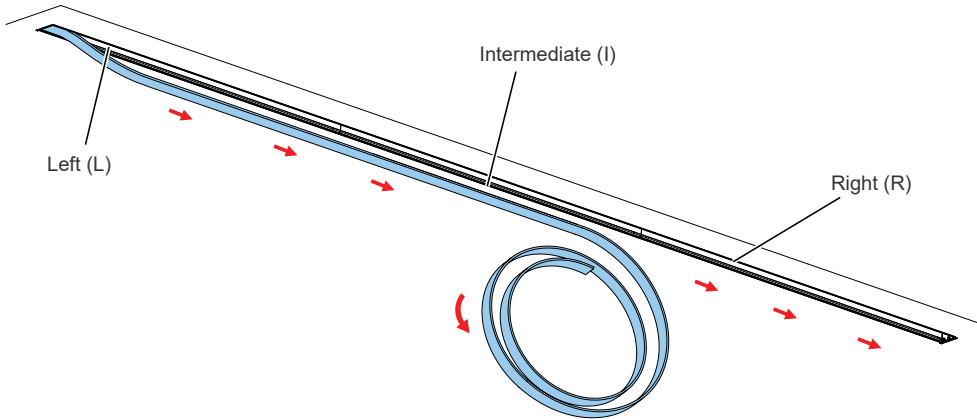

Continuous Lens Joiner Detail

RUN PATTERNS, CORNERS, & JUNCTIONS

Patterns can be configured in 1' increments with illuminated L (corner), X, Y, & T connectors. Standard corner has 2' leg segments. Standard L (corner) connector angles are available in 40-179 degrees in 1 degree increments. Standard T & Y connector angles are available in 40-179 degrees in 1 degree increments. Standard X connector angle available in 40-90 degrees in 1 degree increments.

See separate pattern spec sheet for more details.

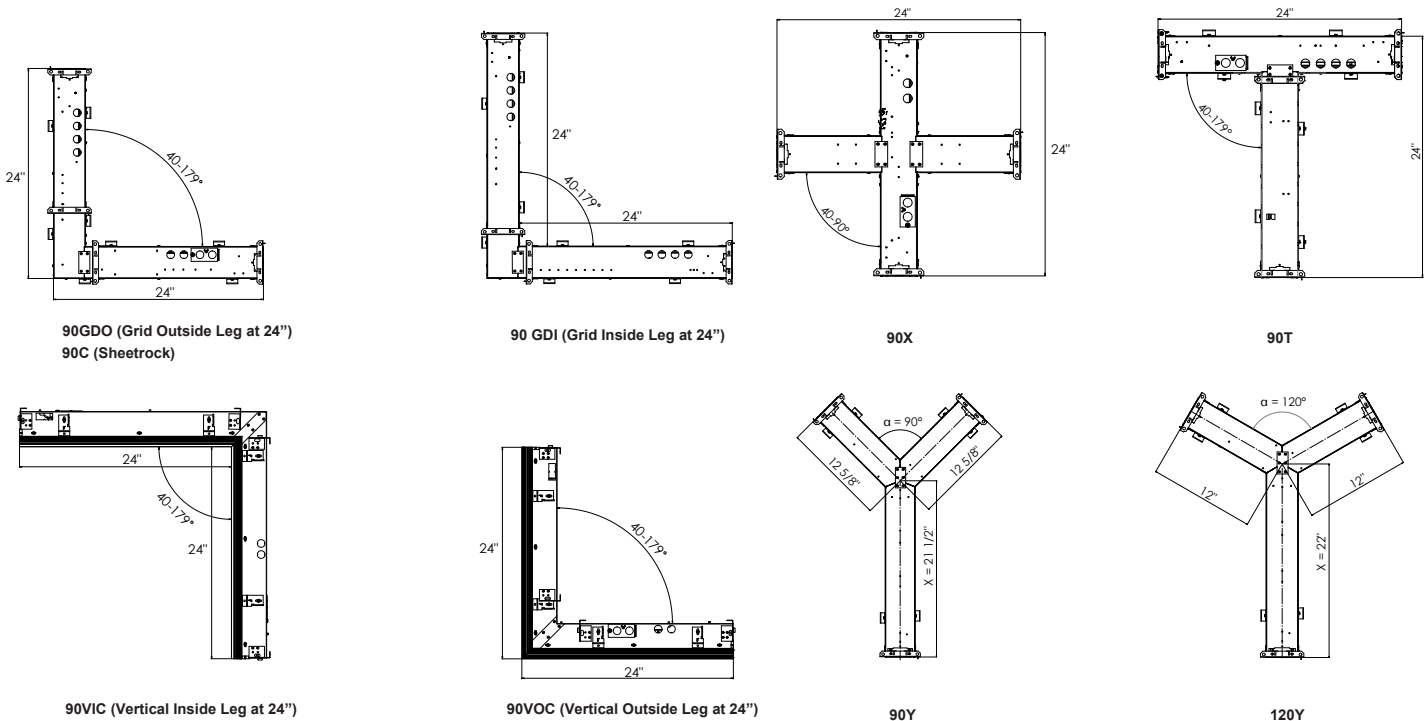

NOTE: For Y intersections, dimension X varies depending on the angle α . Angle α can be in a range of 40-179°.

INTELLIGENT LUMINAIRE GUIDE

Choose nomenclature from these columns

Driver Configuration (MVOLT)	Minimum Dimming Level	+	Control Input	=	Driver	Dimming Range	Notes
	DARK		NLT		eldoLED DUAL drive DT8 compatible		

Choose nomenclature from these columns

Control / Sensor Configurations	Control Input	+	Sensor	=	Sensor*	Notes
	NLT		<blank>		None	
	NLT		ADC		NES ADCX	
	NLT		PDT		NES PDT 7	
	NLT		APIR		NES 7 ADCX	
	NLT		APDT		NES PDT 7 ADCX	

*Note: Only one sensor per zone allowed.

UL924 Sequence of Operation

The below information applies to all nLight AIR devices an EM option.

- EM devices will remain at their high-end trim and ignore wireless lighting control commands, unless a normal-power-sensed (NPS) broadcast is received at least every 8 seconds.
- Using the CLAIRITY+ mobile app, EM devices must be associated with a group that includes a normal power sensing device to receive NPS broadcasts.
- Only non-emergency rPP20, rLSXR, rSBOR, rSDGR, and nLight AIR luminaires with version 3.4 or later firmware can provide normal power sensing for EM devices. See specification sheets for control devices and luminaires for more information on options that support normal power sensing.

nLight * Wired Control Accessories

Order as separate catalog number

Wall Switches	Model Number
On/Off two pole & Raise/Lower CCT	nPODMA 2P DX CCT (color)
On/Off, 4 scene control, dimming, TUWH	nPODMA 4S DX EDUTW (color)
On/Off, 4 scene control, TUWH	nPODMA 4S EDUTW (color)
Graphic touchscreen	nPOD TOUCH (color)

For more information see [nPODMA](#) and [nPOD TOUCH](#) spec sheets.

INTEGRATED SENSOR & LAYOUT

Only one sensor per zone allowed. At the most, the entire run can only have 2 sensors designated. Sensor zone cannot split a fixture section or overlap of zones. Sensors will be located on a Left end or Right end of fixture section. Default location for first sensor is Left end and default location for second sensor is Right end.

CORRECT:

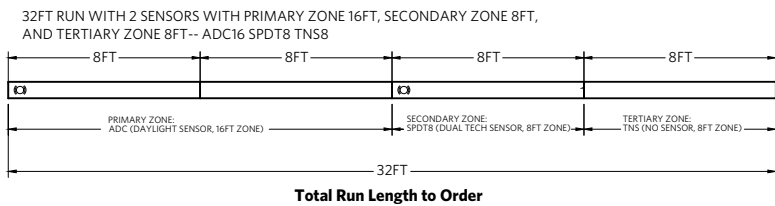
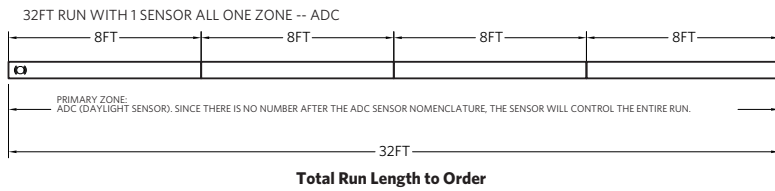
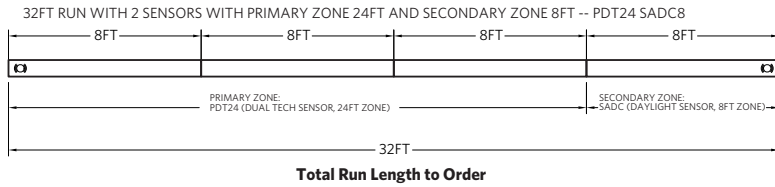

INCORRECT:

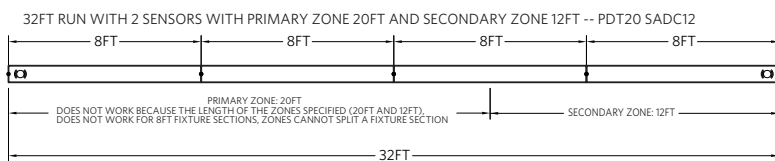
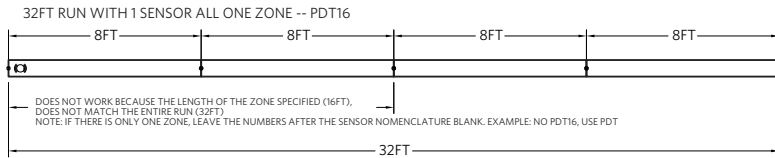

For runs longer than 8FT:
ALWAYS order the run by the **TOTAL RUN LENGTH**. Ordering the sections individually will not provide the correct joining hardware to allow connection in the field.

OCCUPANCY DETECTION COVERAGE

At the 7.5 ft (2.29 m) hanging height of a typical pendant mount fixture the sensor provides 10 ft (3.05 m) radial detection of small motion. At a 9 ft (2.74 m) hanging height the radius is 12 ft (3.66 m) for small motion.

Adequate for walking motion detection from mounting heights between 7.5 ft (2.29 m) and 20 ft (6.10 m).

Initial detection will occur earlier when walking across sensor's field of view than when walking directly at sensor.

Initial detection of walking motion into long coverage segment will occur at distances of 2x the mounting height up to 15 ft (4.57 m) and 1.75x up to 20 ft (6.10 m). Lens assembly rotates 15° to enable adjustment in order to line up long segments.

Tested to NEMA WD 7-2011

SENSOR & SENSOR PLATE DETAIL

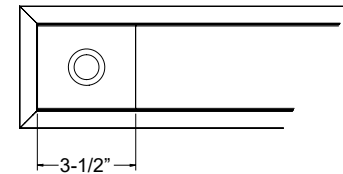
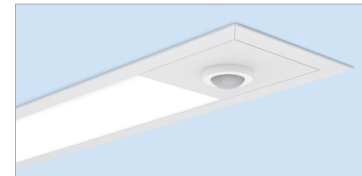

Control Input	
Sensor	NLT
ADC	NES ADCX
APDT	NES PDT 7 ADCX
APIR	NES 7 ADCX
PDT	NES PDT 7

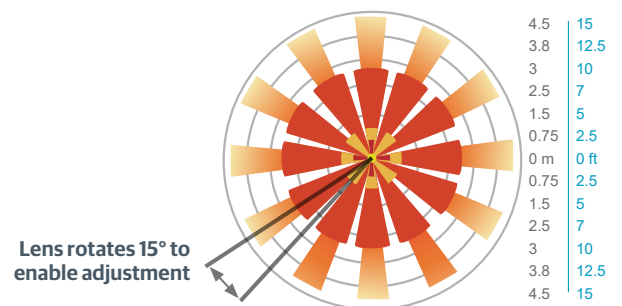

ADDITIONAL OPTIONS

Wet Location (WL)

- * Wet location fixtures can be recognized by the reflector end cap which is already installed into the fixture.
- * Wet location fixtures are available as individual fixture sections starting at 2FT through 8FT maximum run length.
- * Wet location is suitable for covered ceiling mount installation only, where any water exposure is from beneath the non-porous mount surface.
- * Lens is not sealed or gasketed.

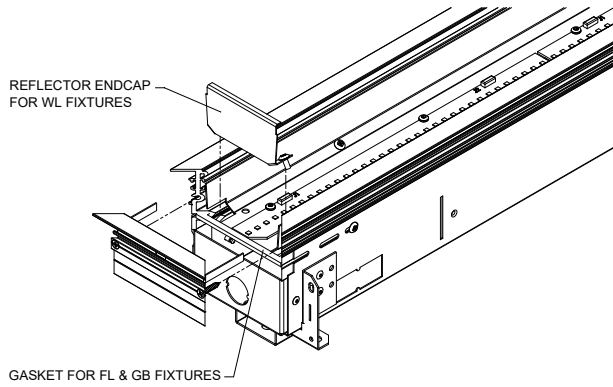

EMERGENCY OPTIONS

Emergency Battery Pack

The [PS1055LCP](#) battery is integral or remote to the fixture and comes standard with test switch and self-diagnostics. Standard emergency operation as indicated below.

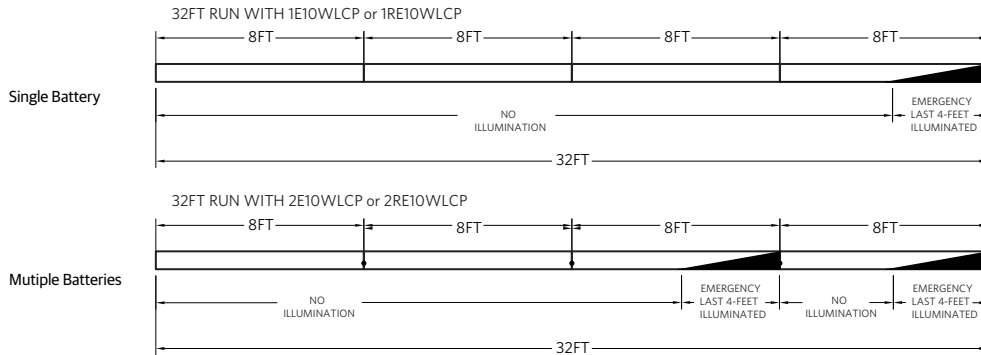

Emergency Circuits

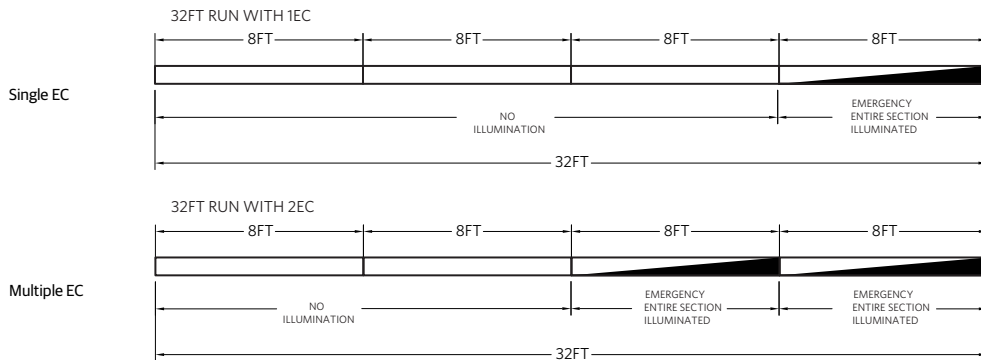

How to Estimate Delivered Lumens in Emergency Mode (E10WLCP or RE10WLCP)
Use the formula below to estimate the delivered lumens in emergency mode

Delivered Lumens = 1.25 x P x LPW
P = 10W for PS1055LCP
LPW = Lumen per watt rating of the luminaire (Available on page 1 of this spec sheet or appropriate IES file.)
(Available on page 1 of this spec sheet or appropriate IES file.)

Per tested performance data, maximum mount height of 17-feet calculated to achieve 1 footcandle (10.8 lux) of illumination below emergency battery powered fixture on the path of egress. (Based on fixture tested with 90CRI 27K LED.)

Section Length	Control Input		
	Integral (E10WLCP)	Remote (RE10WLCP)	EC
U2-U2/11.875	n/a	Entire Section Length	Entire Section Length
U3-U3/11.875	n/a	Entire Section Length	Entire Section Length
U4	Entire Section Length	Entire Section Length	Entire Section Length
U4/0.125-U4-11.875	n/a	Last 2-feet of Section Length	Entire Section Length
U5-U5/11.875	Last 3-feet of Section Length	Last 3-feet of Section Length	Entire Section Length
U6-U6/11.875	Last 3-feet of Section Length	Last 3-feet of Section Length	Entire Section Length
U7-U7/11.875	Last 4-feet of Section Length	Last 4-feet of Section Length	Entire Section Length
U8	Last 4-feet of Section Length	Last 4-feet of Section Length	Entire Section Length

Integral Emergency Test Switch

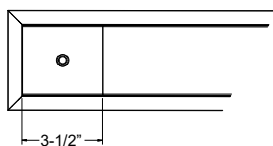
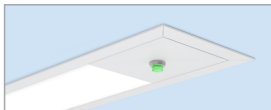

EMERGENCY OPTIONS (Continued)

Remote Emergency Battery Pack

10w linear constant power emergency LED driver is remote mounted from the luminaire. The emergency driver switches power from the normal AC driver and operates the fixture for 90 minutes in the emergency mode from the unit's battery supply. Consists of (1) emergency LED driver within (1) remote mounting enclosure, flexible conduit, test switch, indicator light, cover plate and junction box supplied.

Maximum remote mounting distance from test switch to fixture not to exceed 25-feet.

The maximum emergency remote distance recommended by the manufacturer is 25-feet with 18 AWG wires.

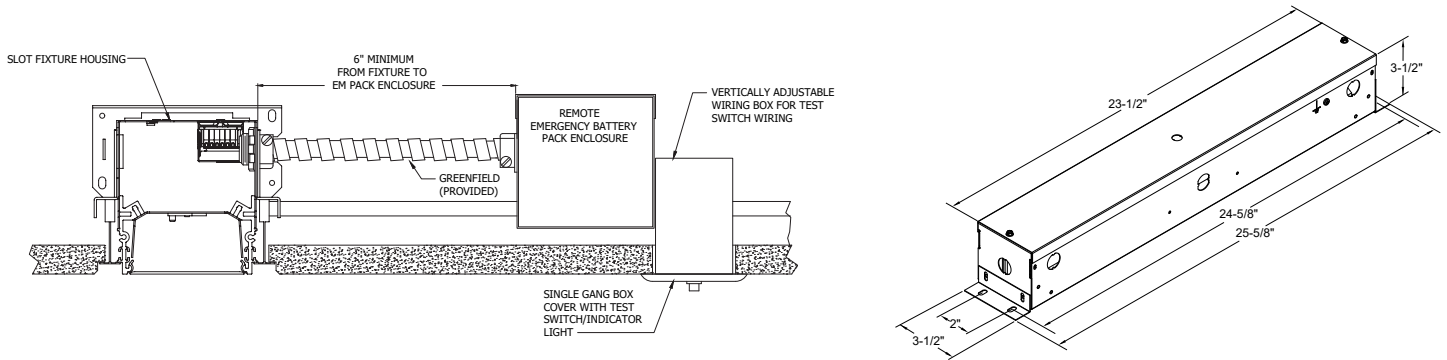

Remote GTD Mounting Option

Emergency generator transfer device is remote mounted from the luminaire. The generator transfer device senses the loss of normal AC power and switches the LED driver input power connection to an unswitched, generator (or central inverter) supplied lighting circuit bypassing the fixture wall switch. Consists of (1) emergency generator transfer device within (1) remote mounting enclosure with 6-foot long flexible conduit.

Maximum remote mounting distance is 6 feet from fixture.

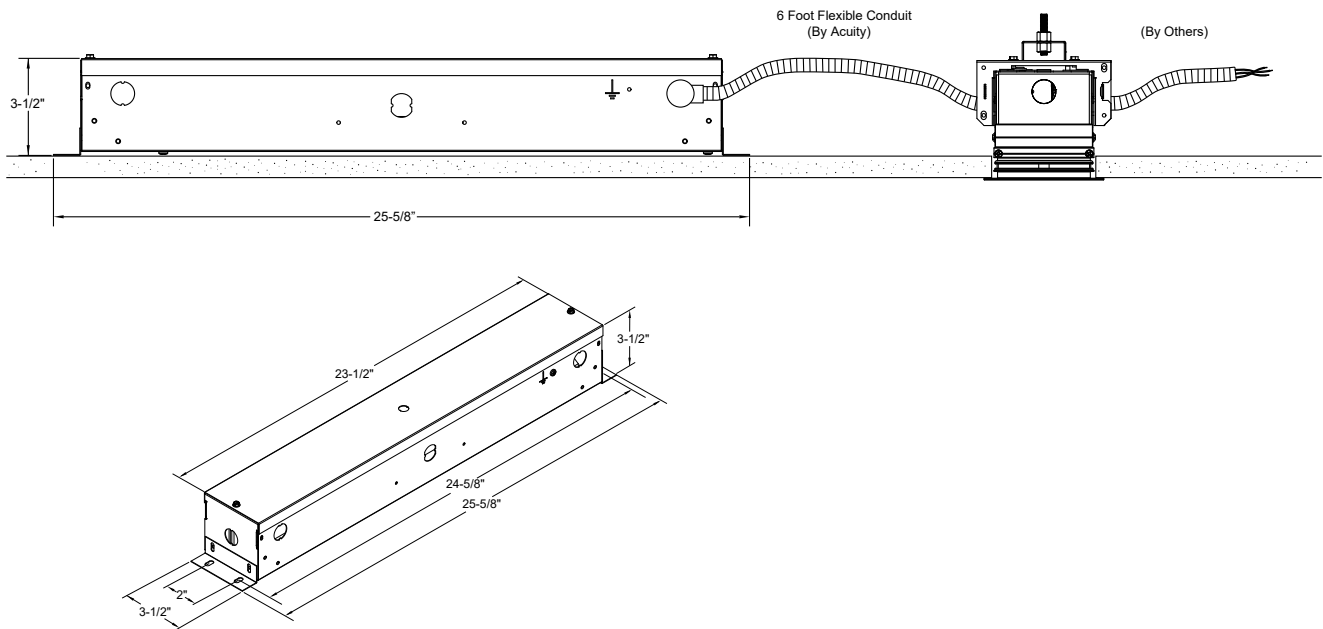

SPECIFICATIONS

Housing

Nominal 4" x 2', 3', 4', 5', 6', 7', 8' and continuous rows in 1/8" increments starting at 2', as standard. Upper housing fabricated from cold-rolled steel with extruded aluminum ceiling trim.

Finish

Standard colors for fixture trims are polyester powder coated white, anti-microbial white, black, or silver with satin sheen. Consult factory for custom colors or specify RAL colors from Architectural brochure.

Reflector

Precision-formed steel; high reflectance matte white powder coat; 93% reflectivity.

Optics (Distribution)

Wall Wash (WW), Wall Graze (WG), Direct Batwing (DBW), and Direct Asymmetric (DAS) incorporate co-extruded lenses and films.

Lenses/Shielding

Extruded acrylic lens, (CLL, FLL). Aluminum louver with either a powder coat finish to match housing color (LVRR) or aluminum finish (LVRRRA). Extruded acrylic drop lens (DRP05, DRP1, DRP15).

Mounting

Sheetrock: Recessed ceiling only to accommodate sheetrock, 1/2" minimum to 1-1/2" maximum depth for FL, GB, FLINB or GBINB trim options. Grid: To accommodate 9/16" Flat Tee with Lay-In Tile, 9/16" Flat Tee with Tegular Tile, 9/16" Slot Tee with Tegular Tile, 15/16" Flat Tee with Lay-In Tile, & 15/16" Flat Tee with Tegular Tile.

LED Source

Multiple lumen packages available in Rhythm Range (2700K-6500K) in 90CRI. The Acuity Brands circuit boards for the linear LED components use a precise binning algorithm which creates a consistent color temperature from board to board. Color variation of no greater than a 2.5 Step MacAdam (2.55DECM) along the black body locus from board to board.

Electrical

Long-life LEDs, coupled with high-efficiency drivers, provide superior quantity and quality of illumination for extended service life. 90% LED lumen maintenance at 60,000 hours (L90/60,000).

Circuits

Single switching option only.

Dimming Driver

Factory tuned constant current electronic dimming driver is standard. Flicker free dimming available down to <1%. LED drivers perform within the recommended operating areas for flicker as a function of frequency and modulation (%) IEEE Standard 1789-2015 (IEEE Recommended Practices for Modulating Current in High-Brightness LEDs for Mitigating Health Risks to Viewers), in typical operating conditions at representative dimming levels. Electrical specifications at maximum driver load: PF > 0.9 and THD <20%. Meets FCC Title 47 Class A or Class B. All drivers are RoHS compliant.

Controls System Networking Options

Optional integrated nLight® controls make each fixture addressable - allowing it to digitally communicate with other nLight enabled controls such as dimmers, switches, occupancy sensors, and photocontrols. Wired networking through standard Cat-5 cabling. (cabling "by others")

Mainstream Dynamic with nTune Technology

This luminaire is enabled with nTune technology, meaning it has the ability to communicate digitally over an nLight network. When wired, using CAT-5 cabling, with other nLight-enabled sensors, power packs, or WallPods, an nLight control zone is created. Once linked to a Gateway, directly or via a Bridge, the zone becomes capable of timeclock control, remote status monitoring, and control via SensorView software.

Emergency Battery (Optional)

Integral emergency battery (E10WLCP) for 90 minutes of operation. Emergency battery pack, 10W, Linear Constant Power Certified in CA Title 20 MAEDBS. Integrated test switch and indicator light. Remote emergency battery (RE10WLCP) for 90 minutes of operation. Emergency battery pack, 10W, Linear Constant Power Certified in CA Title 20 MAEDBS. Remote enclosure, flexible conduit, test switch, indicator light, cover plate and junction box supplied. Remote generator transfer device (GTD) works in conjunction with an auxiliary generator or a central inverter system to power fixtures for safe egress lighting.

Ambient Operating Temperature Range

-20°C (-4° F) to +25°C (+77°F)

Environment

Suitable for damp location. Indoor use only. Optional Wet (WL) location exterior use available with specified nomenclature.

Certification

CSA certified to meet U.S. and Canadian standards (UL1598 and UL8750). This product is IC rated. Optional Wet (WL) location listing available with specified nomenclature. Wet location listing is suitable for covered ceiling mount installation only, where any water exposure is beneath the non-porous mount surface.

Fixture Weight

Approximately 5.0 lbs per foot, less packaging.

Government Procurement

BAA - Buy America(n) Act: Product qualifies as a domestic end product under the Buy American Act as implemented in the FAR and DFARS. Product also qualifies as manufactured in the United States under DOT Buy America regulations.

BABA - Build America Buy America: Product qualifies as produced in the United States under the definitions of the Build America, Buy America Act.

Please refer to www.acuitybrands.com/buy-american for additional information.

Warranty

5-year limited warranty. This is the only warranty provided and no other statements in this specification sheet create any warranty of any kind. All other express and implied warranties are disclaimed. Complete warranty terms located at: www.acuitybrands.com/support/warranty/terms-and-conditions

Notes: Actual performance may differ as a result of end-user environment and application.

All values are design or typical values, measured under laboratory conditions at 25 °C.

Specifications subject to change without notice.