

SLOT 6

RECESSED

HIGHLIGHTS

- 300 to 1500 lumens per foot Direct
- Two lens depths: OD (Flush) and 1D (1" Regress)
- 3 direct distributions: Lambertian, Batwing, or Asymmetric
- Two lens treatment options: Continuous and Flush
- Optional integrated downlight options
- Integrated control with optional nLight® or nLight Air® for system networking
- Driver options for Dim to Dark, 1% or 10% minimum dimming
- White, black or silver paint with satin finish
- UGR data available on page 4

DIMENSIONS

Section View

FL Trim with OD Lens Regress

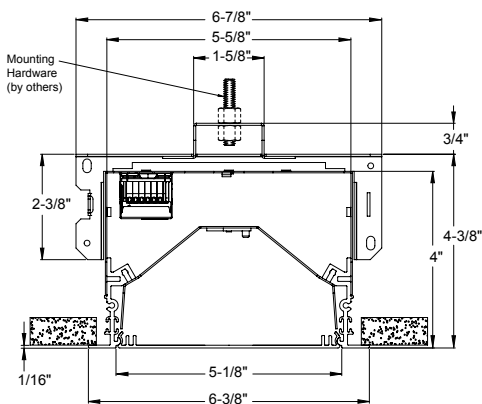

FIXTURE PERFORMANCE

Nominal Lumens/Foot	Direct							
	300LMF	400LMF	600LMF	800LMF	1000LMF	1200LMF	1300LMF	1500LMF
Delivered Lumens/Foot	288	384	575	755	930	1121	1205	1375
Input Watts/Foot	2.58	3.40	5.04	6.78	8.50	10.50	11.65	13.95
Lumens/Watt	111	113	114	111	109	107	103	99

Based on a 4FT 90CRI 35K fixture with 0" depth lens regress (OD), standard lambertian distribution, and flush lens (FLL)



DIRECT DISTRIBUTION

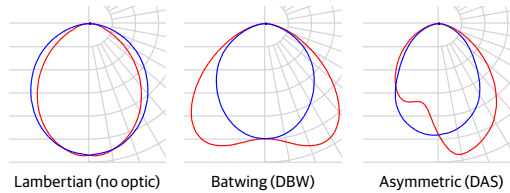

DIFFUSERS/SHIELDING

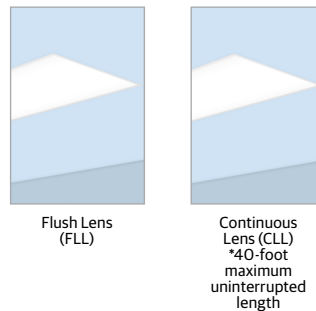

ORDERING

Example: S6RD LOP 56FT OD FL 90CRI 40K 100LMF 5DL S80CRI S30K S74OLM S25DEG WBL DCT DARK FLL MVOLT WHTT ZT

Series	Linear Plan	Total Run Length	Lens Regress Depth	Ceiling Type	Direct Light Source Color Rendering	Direct LED Color Temperature
S6RD Slot 6 Recessed Direct	LOP Optimized Length	_FT_ Specify continuous linear feet to nearest 1/8" increments starting at 2FT (Example: 24' - 61/8" = 24FT6.125) _FT¹ Specify continuous linear feet to whole foot increments starting at 2FT (Example: 24' = 24FT) Unit length may affect available options. For runs longer than 8FT: ALWAYS order the run by the TOTAL RUN LENGTH. Ordering these sections individually will not provide the correct joining hardware to allow run connections in the field. 1. Use whole foot increment when using _DL_sensors , or zoning options.	OD 0" Depth 1D¹²,³,⁴ 1" Depth 1. Available with FLL or CLL. Optional Shielding only. 2. Not available with Direct Distribution options. 3. Not available with Secondary Light Source. 4. Not available with FLINB or GBINB	FL 5/8IN Flange (sheetrock) GB Gypsum Board (sheetrock) FLINB 5/8IN Flange (sheetrock) Install From Below GBINB Gypsum Board (sheetrock) Install From Below TG Grid Ceiling: 9/16" Flat Tee with Lay-In Tile, 9/16" Flat Tee with Tegular Tile, 9/16" Slot Tee with Tegular Tile, 15/16" Flat Tee with Lay-In Tile, & 15/16" Flat Tee with Tegular Tile FLW¹ 5/8IN Flange (sheetrock) Wall Mounted GBW¹ Gypsum Board (sheetrock) Wall Mounted 1. When using FLW or GBW options, FLW will change to FL & GBW will change to GB for shipping lines to designate same fixture as ceiling mounted units. *For compatibility with metal pans, hardwood, or other ceiling types, consult technical support.	90CRI 90CRI	27K 2700K 30K 3000K 35K 3500K 40K 4000K 50K 5000K

Direct LED Light Output	Direct Distribution¹²	Secondary Light Source¹,²,³	Secondary Light Source Color Rendering	Secondary LED Color Temperature	Secondary Light Source Lumen Output	Secondary Light Source Distribution
300LMF 300 Lumens per Foot 400LMF 400 Lumens per Foot 600LMF 600 Lumens per Foot 800LMF 800 Lumens per Foot 1000LMF 1,000 Lumens per Foot 1200LMF 1,200 Lumens per Foot 1400LMF 1,400 Lumens per Foot 1500LMF 1500 Lumens per Foot _LMF Specify Lumens between 300LMF and 1500LMF in 50LMF increments	<blank> Lambertian DAS Direct asymmetric distribution DBW Direct Batwing Distribution 1. Direct Distribution options are only available with FLL Direct Shielding and OD Lens Regress Depth option. 2. DAS not available with downlight Secondary Light Source.	<blank> No Downlight Option _DL LED downlights per run (Example: 4DL = Four quantity downlights in run) 1. Not available with sensors or emergency in same fixture length. 2. Downlights not available in fixture lengths from 2FT through 3FT11.875 3. Available with maximum 1000LMF for complete linear run.	<blank> No Downlight Option S80CRI 80CRI	<blank> No Downlight Option S27K 2700K S30K 3000K S35K 3500K S40K 4000K	<blank> No Downlight Option S74OLM 74OLM (2x2 cell Square)	<blank> No Downlight Option S25DEG 25 Degrees S50DEG 50 Degrees

Secondary Light Source Baffle Color	Switching	Minimum Dimming Level	Optional Shielding	Voltage	Finish
<blank> No Downlight Option WBL White BSBL Black Specular CSBL Clear Specular	SCT Single Circuit DCT¹ Double Circuit 1. Required when downlights are required	DARK Constant Current, Dimming to 0.1% MINI² Constant Current, Dimming to 1% MINIO² Constant Current, Dimming to 10% NODIM¹,² Non Dimming 1. Not available with Control Input or Sensors 2. Not available with DALI	CLL¹,³ Continuous Flush Lens FLL² Flush Lens 1. CLL is not available with DAS or DBW distributions. 2. When using distribution options, FLL will change to FLLC to designate a co-extruded lens with white and clear material. 3. 40-foot maximum uninterrupted length.	MVOLT 120-277V 120³ 120V 277³ 277V 347¹,² 347V 1. Available with NODIM, MINI, or MINIO dimming and ZT. 2. Not available with E10WLCP, RE10WLCP, or GTD. 3. Required with GTD.	WHTT White (Satin) AMF Antimicrobial White BLKT Black (Satin) SLVT Silver (Satin) RALTBDD¹ RAL Paint Finish 1. RALTBDD is for pricing only. Replace with applicable RAL number & sheen when placing order

Emergency Options	Control Input	Primary Sensor or Zone¹,⁴	Secondary Sensor or Zone¹,⁴
<blank> No Emergency Option _E10WLCP¹,⁴ Total number of 10W Battery Packs, Constant Power, Self Diagnostic, T20 Compliant _RE10WLCP Total Number of Remote 10W Battery Packs, Constant Power, Self Diagnostics, T20 Compliant _EC Total Number of Emergency Circuits GTD³ Generic Transfer Device WEC² EC Circuit for Entire Run 1. E10WLCP is not available in units 2' to 3'-11-7/8"; 4'-0-1/8" to 4'-11-7/8"; or with 1D option. 2. WEC is not available with NLIGHT, NLTAIR2, or sensors. 3. GTD is remote mounted. GTD is not available with 347 or CP options. 4. Available with maximum 1300LMF for complete linear run.	<blank> Non-Dimming ZT 0-10V DALI¹,² DALI NLIGHT nLight Wired NLTAIR2³,⁴ nLight AIR 2 Wireless Enabled 1. Only available with DARK. 2. Not available with sensor. 3. NLTAIR2 can be used as a normal power sensing device for nLight Air devices and luminaires with EM emergency options. It is not available with WL. 4. Not available with Downlights	<blank> No Sensor or Primary Zone Option NS Primary Zone with No Sensor (Specify zone length in feet.) ADC_² Daylight Dimming Sensor with Primary Zone Length (Specify zone length in feet.) PDT_² Dual Technology Occupancy Sensor, PIR and Microphonics Sensor with Primary Zone Length (Specify zone length in feet.) APIR_³ Passive Infrared Occupancy and Daylight Dimming Sensor (Specify zone length in feet.) APDT_³ Dual Technology Occupancy and Daylight Dimming Sensor (Specify zone length in feet.) 1. Available in whole foot run with OD and FLL or CLL. 2. Available with ZT or NLIGHT Control Input. 3. Available with ZT, NLIGHT, or NLTAIR2 Control Input. 4. Available with FLINB & GBINB in maximum 1300LMF.	<blank> No Sensor or Secondary Zone Option SNS_ Secondary Zone with No Sensor (Specify zone length in feet.) SADC_² Daylight Dimming Sensor, Secondary Zone (Specify zone length in feet.) SPDT_² Dual Technology Occupancy Sensor, PIR and Microphonics Sensor, Secondary Zone (Specify zone length in feet.) SAPIR_³ Passive Infrared Occupancy and Daylight Dimming Sensor, Secondary Zone (Specify zone length in feet.) SAPDT_³ Dual Technology Occupancy and daylight dimming sensor, Secondary Zone (Specify zone length in feet.) 1. Available in whole foot run with OD and FLL or CLL. 2. Available with ZT or NLIGHT Control Input. 3. Available with ZT, NLIGHT, or NLTAIR2 Control Input. 4. Available with FLINB & GBINB in maximum 1300LMF.

Tertiary Zone Indicator	Options
<blank> No Tertiary Zone TNS_ Tertiary Zone (Specify zone length in feet.)	CP⁵ Chicago Plenum BAA Buy America(n) Act and/or Build America Buy America Qualified 4. Available as individual fixture sections, starting at 2FT through 8FT maximum run length. 5. Not available with NLTAIR2 or GTD. 6. Not available with downlights. 7. Not available with E10WLCP.

PHOTOMETRICS

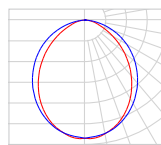

Test Report: ISF25 000770P2573
IES LM79-08
Catalog #: S6RD 4FT OD 90CRI 35K
1000LMF STD FLL
Lumens: 3718
Wattage: 34.00
Efficacy: 109.35

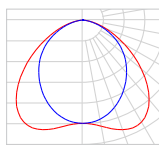

Test Report: ISF25 036529P363
IES LM79-08
Catalog #: S6RD 4FT OD 90CRI 35K
1000LMF DBW FLLC
Lumens: 3803
Wattage: 34.00
Efficacy: 111.86

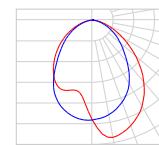

Test Report: ISF25 024633P1378
IES LM79-08
Catalog #: S6RD 4FT OD 90CRI 35K
1000LMF DAS FLLC
Lumens: 4041
Wattage: 34.00
Efficacy: 118.86

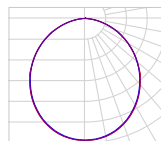

Test Report: ISF25 024629P1348
IES LM79-08
Catalog #: S6RD 4FT OD 90CRI 35K
1000LMF STD CLL
Lumens: 3685
Wattage: 34.00
Efficacy: 108.38

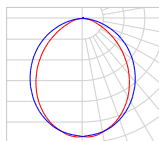

Test Report: ISF25 000770P1136
IES LM79-08
Catalog #: S6RD 4FT ID 90CRI 35K
1000LMF STD FLL
Lumens: 3510
Wattage: 34.00
Efficacy: 103.24

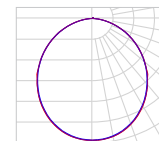

Test Report: ISF25 024629P363
IES LM79-08
Catalog #: S6RD 4FT ID 90CRI 35K
1000LMF STD CLL
Lumens: 3479
Wattage: 34.00
Efficacy: 102.33

PROJECT LED LUMEN MAINTENANCE

Data references the extrapolated performance projections for the platforms noted in a 25°C ambient, based on 10,000 hours of LED testing (tested per IESNA LM-80-08 and projected per IESNA TM-21-11).

To calculate LLF, use the lumen maintenance factor that corresponds to the desired number of operating hours below. For other lumen maintenance values, contact factory.

Operating Hours	0	10,000	60,000	100,000
Lumen Maintenance Factor	1	0.98	0.84	0.75

CCT SCALING CHART

CCT	CRI	MULTIPLIER	R9
27K	90CRI	0.9444	54.61
30K	90CRI	0.9722	69.01
35K	90CRI	1.0000	83.41
40K	90CRI	1.0278	91.19
50K	90CRI	1.0278	90.86

Lumen scaling charts can be used to approximate the lumen values at different Kelvin temperatures, color rendering indices, optics, or shielding.

Example: Calculating the lumen change from 90CRI 35K to 90CRI 40K = Lumen output for S6RD 4FT OD 90CRI 35K 1000LMF FLL (3718) x 1.0278 multiplier = 3821 lumen

OPTICAL SCALING CHARTS

DISTRIBUTIONS	MULTIPLIER
LAMBERTIAN	1.00
DBW	0.99
DAS	1.09
SHIELDING	MULTIPLIER
CLL	0.99
FLL	1.00

*Base fixture with Lambertian distribution and flush lens (FLL)

50LMF INCREMENT SCALING CHART

NOMINAL LMF	LUMEN	WATTAGE
	MULTIPLIER	MULTIPLIER
300LMF	0.31	0.30
350LMF	0.36	0.35
400LMF	0.41	0.40
450LMF	0.46	0.45
500LMF	0.52	0.50
550LMF	0.57	0.54
600LMF	0.62	0.59
650LMF	0.67	0.64
700LMF	0.72	0.69
750LMF	0.76	0.75
800LMF	0.81	0.80
850LMF	0.86	0.85
900LMF	0.91	0.90
950LMF	0.96	0.95
1000LMF	1.00	1.00
1050LMF	1.06	1.05
1100LMF	1.11	1.10
1150LMF	1.16	1.17
1200LMF	1.21	1.24
1250LMF	1.25	1.30
1300LMF	1.30	1.37
1350LMF	1.34	1.44
1400LMF	1.39	1.51
1450LMF	1.43	1.57
1500LMF	1.48	1.64

*Base fixture with 0" depth lens regress (OD), standard lambertian distribution, flush lens (FLL), and 1000LMF

REGRESS DEPTH SCALING CHART

LENS REGRESS DEPTH	MULTIPLIER
OD	1.00
1D	0.94

*Base fixture with Lambertian distribution, 0" depth lens regress (OD), and flush lens (FLL)

UGR CHART

Lumen Package	UGR (70% 50% 20% reflectance using a 4H x 8H room size)					
	Crosswise					
	OD FLL Lambertian	OD CLL Lambertian	OD DBW	OD DAS	1D FLL Lambertian	1D CLL Lambertian
300LMF	19.3	19.3	17.4	16.8	19.1	19.1
400LMF	20.3	20.3	18.4	17.8	20.1	20.1
600LMF	21.7	21.7	19.8	19.2	21.5	21.5
800LMF	22.6	22.7	20.7	20.2	22.4	22.5
1000LMF	23.4	23.4	21.5	20.9	23.2	23.2
1200LMF	24	24	22.1	21.6	23.8	23.8
1400LMF	24.3	24.3	22.4	21.8	24.1	24.1
1500LMF	24.7	24.7	22.8	22.3	24.5	24.5
Lumen Package	Endwise					
	OD FLL Lambertian	OD CLL Lambertian	OD DBW	OD DAS	1D FLL Lambertian	1D CLL Lambertian
	300LMF	16.7	18.9	18.5	18.5	16.5
400LMF	17.7	19.9	19.4	19.5	17.5	19.7
600LMF	19.1	21.3	20.9	20.9	18.9	21.1
800LMF	20	22.3	21.8	21.9	19.8	22.1
1000LMF	20.8	23	22.5	22.6	20.6	22.8
1200LMF	21.4	23.7	23.2	23.3	21.2	23.5
1400LMF	21.7	23.9	23.4	23.5	21.5	23.7
1500LMF	22.1	24.4	23.9	24	21.9	24.2

*UGR varies based on luminaire options and is affected by application dependent parameters. Numbers depicted here are considered "Luminaire-UGR" and/or "Point-UGR" values. To determine a more precise maximum UGR value ("Application-UGR"), a full lighting design layout should be completed with the selected luminaire configuration for each application.

**Click here for more information on: [UGR.FAQ](#)

CEILING TRIMS

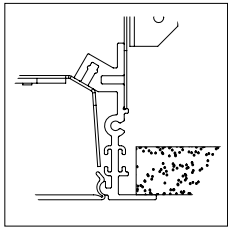

FL
5/8IN Flange (sheetrock)
Install Before Sheetrock

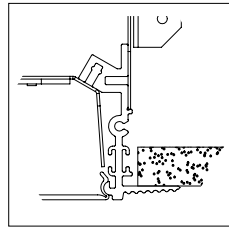

GB
Gypsum Board (sheetrock)
Install Before Sheetrock

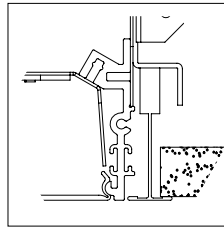

TG
9/16" Flat Tee w/ Lay-in Tile

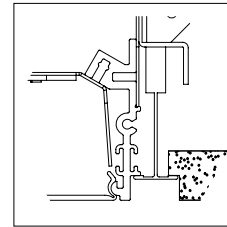

TG
9/16" Flat Tee w/ Tegular Tile

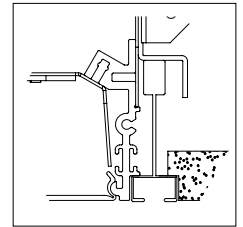

TG
9/16" Slot Tee w/ Tegular Tile

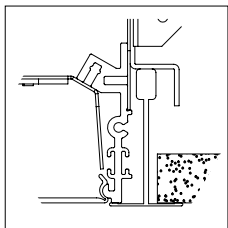

TG
15/16" Flat Tee w/ Lay-in Tile

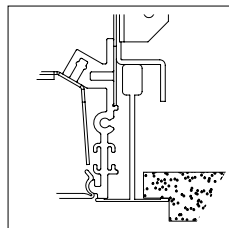

TG
15/16" Flat Tee w/ Tegular Tile

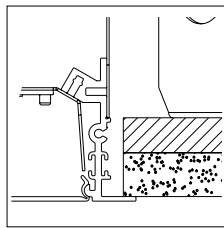

FLINB
5/8IN Flange (sheetrock)
Install From Below

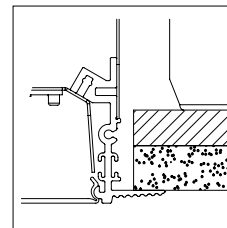

GBINB
Gypsum Board (sheetrock)
Install From Below

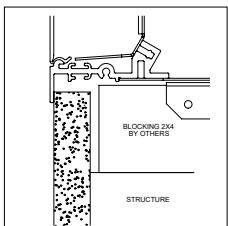

FLW
5/8IN Flange (sheetrock)
Wall Mounted

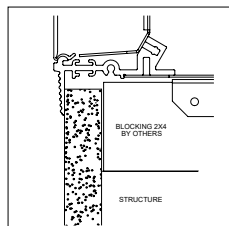

GBW
Gypsum Board (sheetrock)
Wall Mounted

*For compatibility with metal pans, hardwood, or other ceiling types, consult technical support.
*TG ceiling trim types are compatible with Armstrong 6" TECHZONE ceiling grid.

LINEAR PLAN

Mark Lighting calculates a continuous run based on optimizing fixture section length and options selected.

LOP- Linear Optimized Length

This linear plan supplies the run length based on defined length combinations, resulting in an optimized solution with the fewest segments. LOP

8FT	4FT	3FT
-----	-----	-----

Total Run Length

This system is not modular. Runs longer than 8FT will be automatically configured with left, intermediate, and right sections based on nomenclature ordered. Always order the total run length required and not individual sections.

Example: This run to be ordered as one 32FT run.

8FT	8FT	8FT	8FT
-----	-----	-----	-----

Example: This run to be ordered as four 8FT runs. Note: Individual fixtures sections cannot be joined together in the field.

8FT	8FT	8FT	8FT
-----	-----	-----	-----

MOUNTING

FL and GB Trim Run

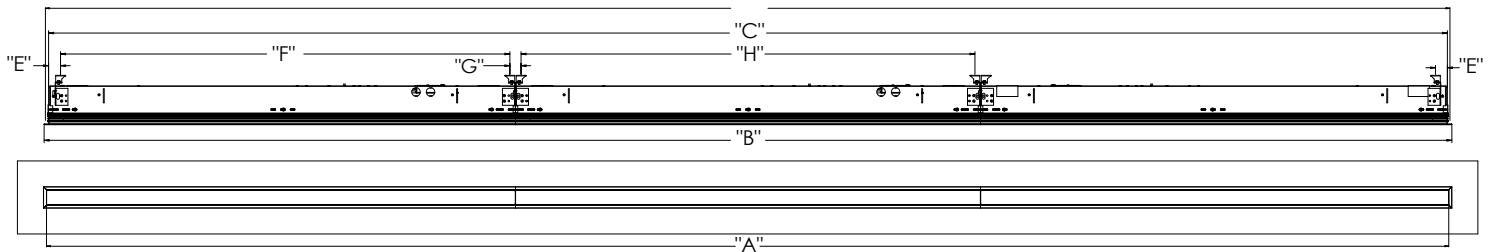

FL Run Configurations							
"A" (Illuminated Length)	"B" (Trim Length)	"C" (Housing Length)	"D" (Cut Opening Length)	"E" (End Mounting Location)	"F" (End Fixture Middle Mounting Point)	"G" (Mounting Point to Mounting Point)	"H" (Mounting Point to Mounting Point Intermediate Fixtures)
Order Length	Ordered Length + 15/16" (FL) + 113/16" (GB)	Order length + 9/16"	Order length + 13/16"	1 1/4"	Fixture length - 1 1/2"	1 1/16"	Fixture length - 1 1/16"

TG Trim Run

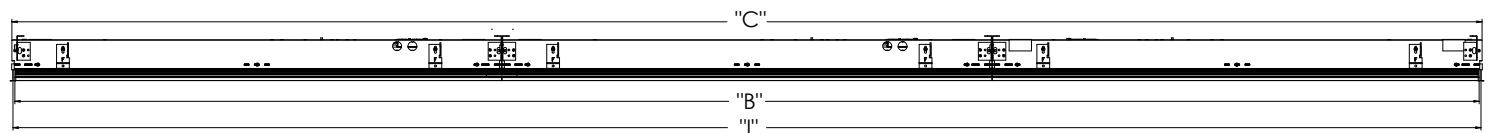

Grid Run Configurations			
"A" (Illuminated Length)	"B" (Trim Length)	"C" (Housing Length)	"I" (Grid Center to Center)
Order length - 13/16"	Ordered Length - 5/8"	Order length - 1/32"	Order length + 13/16"

MOUNTING (continued)

FLINB and GBINB Trim Run

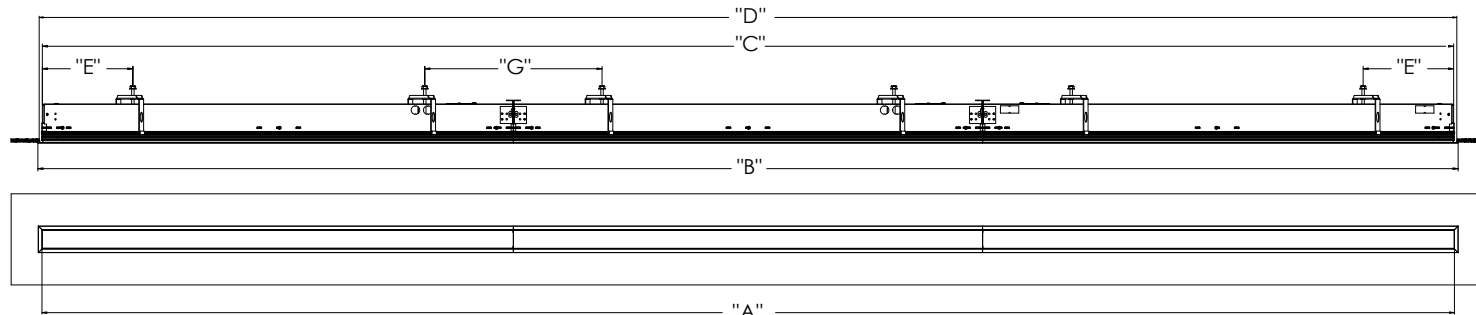

FL Run Configurations					
"A" (Illuminated Length)	"B" (Trim Length)	"C" (Housing Length)	"D" (Cut Opening Length)	"E" (End Mounting Location)	"G" (Mounting Point to Mounting Point)
Order Length	Order Length + 1 5/16"(FLINB) + 1 13/16"(GBINB)	Order length +9/16"	Order length +13/16"	6 1/4" 9 1/4"	1' 0 1/2" 1' 3 1/2" 1' 6 1/2"

NOTE: Dimension "E" depends on length (inconsistent across family). **NOTE:** Dimension "G" depends on fixture combination.

Ceiling Cut Out Dimensions

		2-Foot	3-Foot	4-Foot	5-Foot	6-Foot	7-Foot	8-Foot
TG	GRID CL LENGTH(IN)	24	36	48	60	72	84	96
	GRID CL WIDTH(IN)	6	6	6	6	6	6	6
FL or FLINB	LENGTH(IN)	24.813	36.813	48.81	60.813	72.813	84.81	96.813
	WIDTH(IN)	5.885	5.885	5.89	5.885	5.885	5.89	5.885
GB or GBINB	LENGTH(IN)	24.813	36.813	48.81	60.813	72.813	84.81	96.813
	WIDTH(IN)	5.885	5.885	5.89	5.885	5.885	5.89	5.885

CEILING OPENING DIMENSIONS FOR INSTALLATION, +/-0.13"

MOUNTING (continued)

FIXTURE DIMENSIONS AND WEIGHTS

		2-Foot	3-Foot	4-Foot	5-Foot	6-Foot	7-Foot	8-Foot	
		Individual	GRID CL (IN)	24	36	48	60	72	84
TG	Individual	OVERALL LENGTH (IN)	23.375	35.375	47.375	59.375	71.375	83.375	95.375
		HOUSING LENGTH (IN)	23.938	35.938	47.938	59.938	71.938	83.938	95.938
		APERTURE (IN)	23.125	35.125	47.125	59.125	71.125	83.128	95.125
	Left or Right	2-Foot	3-Foot	4-Foot	5-Foot	6-Foot	7-Foot	8-Foot	
		GRID CL (IN)	24	36	48	60	72	84	96
		PRODUCT LENGTH (IN)	23.688	35.688	47.688	59.688	71.688	83.688	95.688
		HOUSING LENGTH (IN)	23.938	35.938	47.938	59.938	71.938	83.938	95.938
	Intermediate	APERTURE (IN)	23.563	35.563	47.563	59.563	71.563	83.563	95.563
		2-Foot	3-Foot	4-Foot	5-Foot	6-Foot	7-Foot	8-Foot	
		GRID CL (IN)	24	36	48	60	72	84	96
Intermediate	PRODUCT LENGTH (IN)	24	36	48	60	72	84	96	
	HOUSING LENGTH (IN)	23.938	35.938	47.938	59.938	71.938	83.938	95.938	
	APERTURE (IN)	24	36	48	60	72	84	96	

		2-Foot	3-Foot	4-Foot	5-Foot	6-Foot	7-Foot	8-Foot	
		Individual	APERTURE (IN)	24	36	48	60	72	84
FL or FLINB	Individual	PRODUCT LENGTH (IN)	25.250	37.250	49.250	61.250	73.250	85.250	97.250
		HOUSING LENGTH (IN)	24.563	36.563	48.563	60.563	72.563	84.563	96.563
	Left or Right	2-Foot	3-Foot	4-Foot	5-Foot	6-Foot	7-Foot	8-Foot	
		APERTURE (IN)	24	36	48	60	72	84	96
		PRODUCT LENGTH (IN)	24.625	36.625	48.625	60.625	72.625	84.625	96.625
	Intermediate	HOUSING LENGTH (IN)	24.250	36.250	48.250	60.250	72.250	84.250	96.250
		2-Foot	3-Foot	4-Foot	5-Foot	6-Foot	7-Foot	8-Foot	
	Intermediate	APERTURE (IN)	24	36	48	60	72	84	96
		PRODUCT LENGTH (IN)	24	36	48	60	72	84	96
		HOUSING LENGTH (IN)	23.938	35.938	47.938	59.938	71.938	83.938	95.938

		2-Foot	3-Foot	4-Foot	5-Foot	6-Foot	7-Foot	8-Foot	
		GB or GBINB	Individual	APERTURE (IN)	24	36	48	60	72
PRODUCT LENGTH (IN)	25.750			37.750	49.750	61.750	73.750	85.750	97.750
HOUSING LENGTH (IN)	24.563			36.563	48.563	60.563	72.563	84.563	96.563
Left or Right	APERTURE (IN)		24	36	48	60	72	84	96
	PRODUCT LENGTH (IN)		24.875	36.875	48.875	60.875	72.875	84.875	96.875
	HOUSING LENGTH (IN)		24.250	36.250	48.250	60.250	72.250	84.250	96.250
Intermediate									
	2-Foot		3-Foot	4-Foot	5-Foot	6-Foot	7-Foot	8-Foot	
	APERTURE (IN)		24	36	48	60	72	84	96
Intermediate	PRODUCT LENGTH (IN)		24	36	48	60	72	84	96
	HOUSING LENGTH (IN)		23.938	35.938	47.938	59.938	71.938	83.938	95.938

*All values rounded to +/- 1/16"

Approximate Fixture Section Weights	2-Foot	3-Foot	4-Foot	5-Foot	6-Foot	7-Foot	8-Foot
	WEIGHT (LBS)	12	15	18	27	30	33

DIRECT SHIELDING & OPTIONS

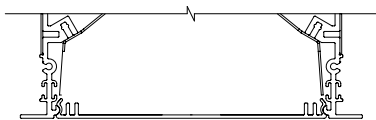

Flush Lens (FLL)
Continuous Lens (CLL)

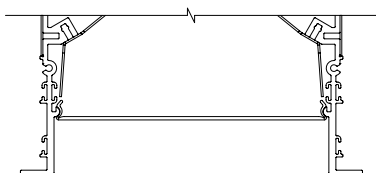

1" Regress with
FLL or CLL

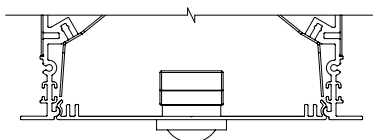

Sensor

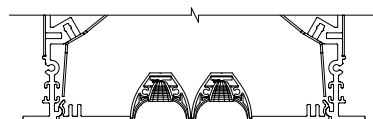

Downlight

DIRECT DISTRIBUTION

Optical Film for DAS and DBW distributions with co-extruded lens standard.
Direction of light for DAS distribution will be in the direction of the notches on the film.

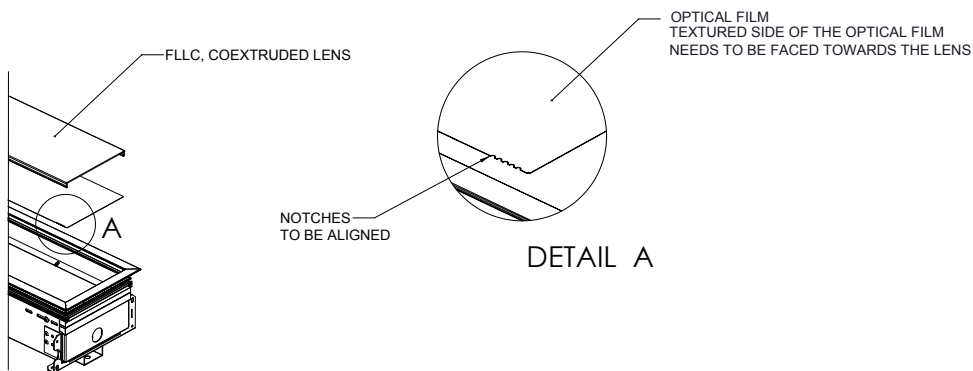

Optical Film	Number of Notches
Diffuser	4
Direct Asymmetric (DAS)	1
Direct Batwing (DBW)	2



When ordering distribution options, use FLL designation. FLL will automatically change to FLLC on shipped product, to designate this co-extruded lens with white and clear material.

CONTINUOUS LENS

40-foot maximum uninterrupted length. From 40-foot 1/8-inch to 106-foot, visible joiner required and supplied with lens rolls. Joiner will match color of trim. Continuous lens and joiners, if required, ship separate from the fixture. Reference installation instructions for further details and steps.

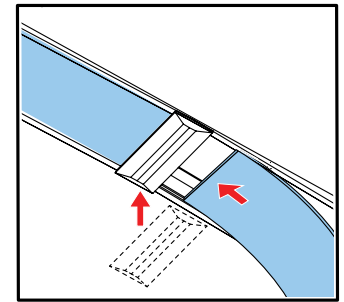
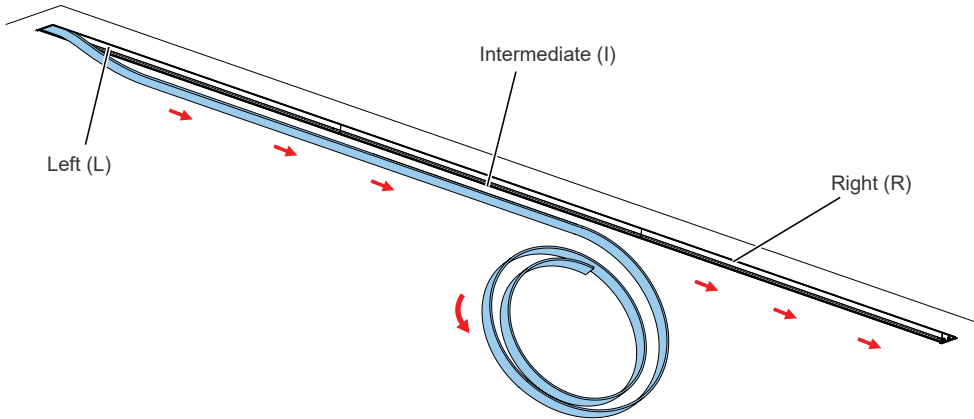

Continuous Lens Joiner Detail

RUN PATTERNS, CORNERS, & JUNCTIONS

Patterns can be configured in 1' increments with illuminated L (corner), X, Y, & T connectors. Standard corner has 2' leg segments. Standard L (corner) connector angles are available in 40-179 degrees in 1 degree increments. Standard T & Y connector angles are available in 40-179 degrees in 1 degree increments. Standard X connector angle available in 40-90 degrees in 1 degree increments.

See separate pattern spec sheet for more details.

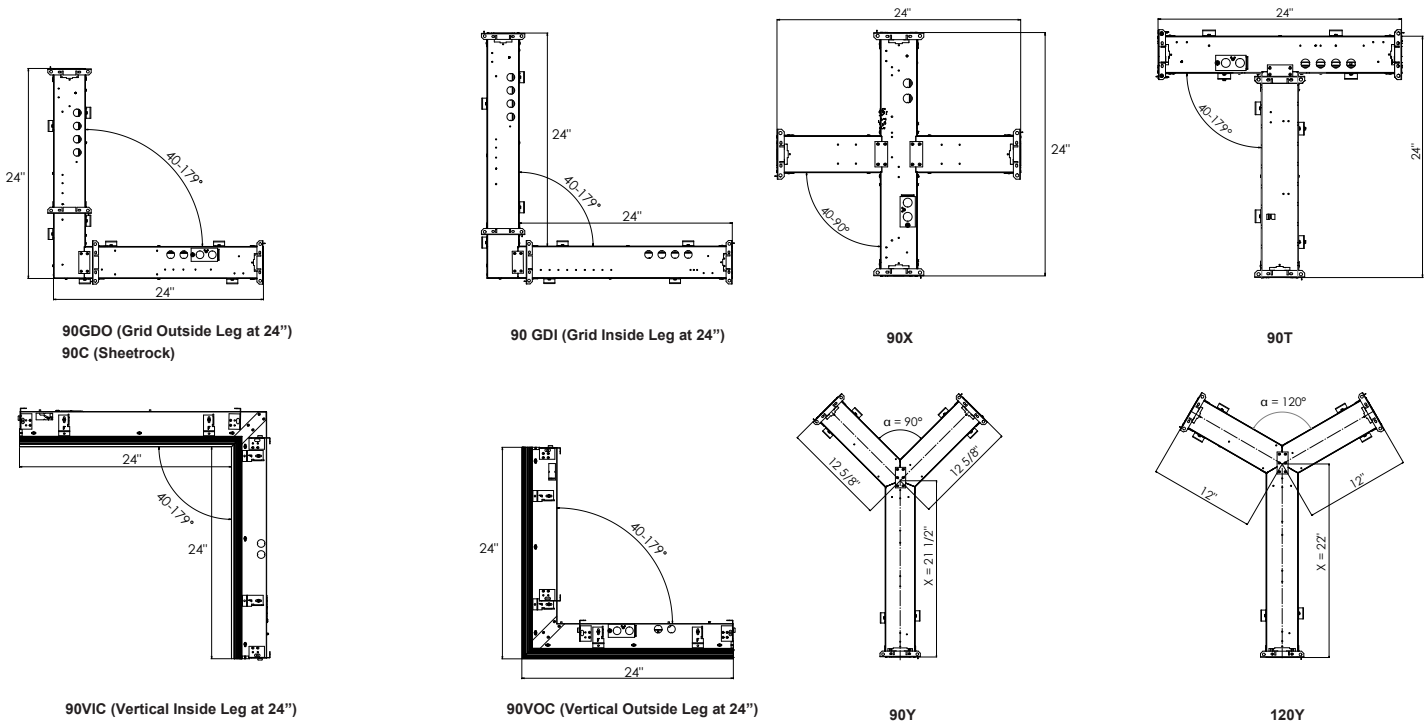

NOTE: For Y intersections, dimension X varies depending on the angle α . Angle α can be in a range of 40-179°.

DOWNLIGHT PHOTOMETRY

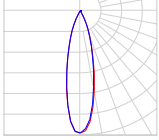

Test Report: ISF25 034790P7
IES LM79-08
Catalog #: S6RD DWNLTONLY 1DL S80CRI
S35K S740LM S25DEG
Lumens: 577
Wattage: 8.95
Efficacy: 64.47

Illuminance at a Distance		Beam Spread(ft)		Field Spread(ft)	
Height(ft)	Center Beam Footcandle	Horizontal	Vertical	Horizontal	Vertical
4	147.76 fc	1.8	1.8	3.9	3.9
8	36.94 fc	3.7	3.6	7.8	7.7
12	16.42 fc	5.5	5.4	11.7	11.6
16	9.23 fc	7.3	7.2	15.5	15.5
20	5.91 fc	9.2	9	19.4	19.3
		Beam Angle		Field Angle	
		25.8°	25.3°	51.8°	51.6°

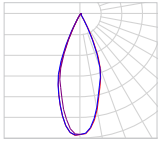

Test Report: ISF25 032238P7
IES LM79-08
Catalog #: S6RD DWNLTONLY 1DL S80CRI
S35K S740LM S50DEG
Lumens: 577
Wattage: 8.95
Efficacy: 64.47

Illuminance at a Distance		Beam Spread(ft)		Field Spread(ft)	
Height(ft)	Center Beam Footcandle	Horizontal	Vertical	Horizontal	Vertical
4	91.01 fc	2.9	2.9	4.4	4.4
8	22.75 fc	5.7	5.7	8.7	8.7
12	10.11 fc	8.6	8.6	13.1	13.1
16	5.69 fc	11.5	11.4	17.5	17.4
20	3.64 fc	14.3	14.3	21.8	21.8
		Beam Angle		Field Angle	
		39.4°	39.4°	57.3°	57.1°

DOWNLIGHT CCT SCALING CHART

S740LM = 2 Row X 2 Cell Configuration

CCT	CRI	MULTIPLIER
S27K	S80CRI	0.97
S30K	S80CRI	1.00
S35K	S80CRI	1.01
S40K	S80CRI	1.02

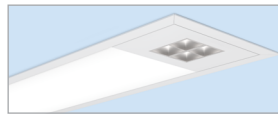

CSBL (Clear Specular Baffle Color)

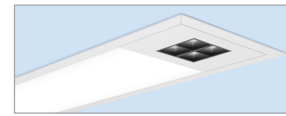

BSBL (Black Specular Baffle Color)

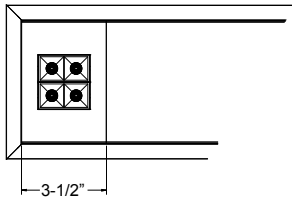

WBL (White Baffle Color)

DOWNLIGHT POSITIONING

Standard Downlight Placement per Fixture Section Length	
4-Foot and 5 Foot	6-Foot, 7-Foot, and 8-Foot
DL/L = Downlight on Left End	DL/L = Downlight on Left End
DL/R = Downlight on Right End	DL/R = Downlight on Right End
DL/L/R = Downlight on Both Ends	DL/M = Downlight in Middle
	DL/L/R = Downlight on Both Ends
	DL/L/R/M = Downlight on Both Ends and in Middle

Note: Minimum of 3-foot on-center spacing required.

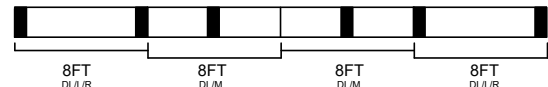
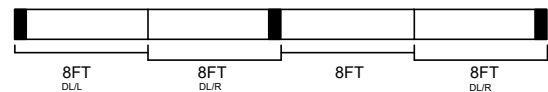
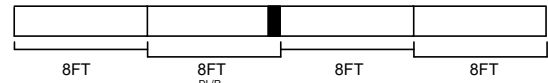

INTELLIGENT LUMINAIRE GUIDE

Choose nomenclature from these columns

Driver Configuration (MVOLT)	Minimum Dimming Level	Control Input	Dimming Range	Driver	Notes	
	NODIM	(blank)		eldoLED Optotronic Oti 30/50/85	No control leads from driver	
	MIN10	ZT	100% to 10%	eldoLED Optotronic Oti 30/50/85	Linear (LIN) Dimming, supplied with leads for 0-10V control	
	MIN1	ZT	100% to 1%	eldoLED Optotronic Oti 30/50/85	Linear (LIN) Dimming, supplied with leads for 0-10V control	
	DARK	ZT	100% to 0.1%	eldoLED SOLODrive 30/50/75	Logarithmic (LOG) Dimming, supplied with leads for 0-10V control	
	MIN10	NLIGHT	100% to 10%	eldoLED SOLODrive 30/50/75	Linear (LIN) Dimming, internal NIO EZ PH J100 included with luminaire*	
	MIN1	NLIGHT	100% to 1%	eldoLED SOLODrive 30/50/75	Linear (LIN) Dimming, internal NIO EZ PH J100 included with luminaire*	
	DARK	NLIGHT	100% to 0.1%	eldoLED SOLODrive 30/50/75	Logarithmic (LOG) Dimming, internal NIO EZ PH J100 included with luminaire*	
	MIN10	NLTAIR2	100% to 10%	eldoLED SOLODrive 30/50/75	Linear (LIN) Dimming, internal RIO ZTS EXT900 ACWH 90D G2 included with luminaire*	
	MIN1	NLTAIR2	100% to 1%	eldoLED SOLODrive 30/50/75	Linear (LIN) Dimming, internal RIO ZTS EXT900 ACWH 90D G2 included with luminaire*	
	DARK	NLTAIR2	100% to 0.1%	eldoLED SOLODrive 30/50/75	Logarithmic (LOG) Dimming, internal RIO ZTS EXT 900 ACWH 90D G2 included with luminaire*	
	DARK	DALI	100% to 0.1%	eldoLED SOLODrive 30/50/75	Logarithmic (LOG) Dimming, DALI controls by others	
	Driver Configuration (347)	NODIM	(blank)		eldoLED Optotronic Oti 30/50/87	No control leads from driver
	MIN1	ZT	100% to 1%	eldoLED Optotronic Oti 30/50/88	Linear (LIN) Dimming, supplied with leads for 0-10V control	
	MIN10	ZT	100% to 10%	eldoLED Optotronic Oti 30/50/89	Linear (LIN) Dimming, supplied with leads for 0-10V control	

*Note: Only one nLight device (r10/n10) per zone allowed.

Choose nomenclature from these columns

Control / Sensor Configurations	Control Input	Sensor	Sensor*	Notes
	ZT	ADC	MSD EZ ADC	Automatic dimming control integral photocell
	ZT	PDT	MSD PDT 7 EZ	Dual technology integral occupancy sensor.
	ZT	APIR	MSD 7 EZ ADC	PIR integral occupancy sensor with automatic dimming control photocell.
	ZT	APDT	MSD PDT 7 EZ ADC	Dual technology integral occupancy sensor with automatic dimming control photocell.
	NLIGHT	ADC	NES ADCX	Automatic dimming control integral photocell. nLight enabled.
	NLIGHT	PDT	NES PDT 7	360° Dual technology integral occupancy sensor. nLight enabled.
	NLIGHT	APIR	NES 7 ADCX	360° PIR integral occupancy sensor with automatic dimming control photocell. nLight enabled.
	NLIGHT	APDT	NES PDT 7 ADCX	360° Dual technology integral occupancy sensor with automatic dimming control photocell. nLight enabled.
	NLTAIR2	ADC	None	Not currently available
	NLTAIR2	PDT	None	Not currently available
	NLTAIR2	APIR	RES7 ZTS EXT900 ACWH 90D G2	PIR integral occupancy sensor with automatic dimming control photocell. nLight AIR enabled.
	NLTAIR2	APDT	RES7 PDT ZTS EXT900 ACWH 90D G2	Dual technology integral occupancy sensor with automatic dimming control photocell. nLight AIR enabled.
	DALI	None	None	No sensors compatible with DALI

*Note: Only one sensor per zone allowed.

INTELLIGENT LUMINAIRE GUIDE (continued)

Choose nomenclature from these columns

Downlight Driver Configuration (MVOLT)	Minimum Dimming Level	Control Input	Downlight	Driver	Notes
	(blank)	NODIM	S370LM	eldoLED Optotronic Oti 30/50	No control leads from driver, 1x2 Aculux Lini Module
	(blank)	NODIM	S740LM	eldoLED Optotronic Oti 30/50	No control leads from driver, 2x2 Aculux Lini Module
	ZT	MINIO	S370LM	eldoLED Optotronic Oti 30/50	Linear (LIN) Dimming, supplied with leads for 0-10V control, 1x2 Aculux Lini Module
	ZT	MINIO	S740LM	eldoLED Optotronic Oti 30/50	Linear (LIN) Dimming, supplied with leads for 0-10V control, 2x2 Aculux Lini Module
	ZT	MINI	S370LM	eldoLED Optotronic Oti 30/50	Linear (LIN) Dimming, supplied with leads for 0-10V control, 1x2 Aculux Lini Module
	ZT	MINI	S740LM	eldoLED Optotronic Oti 30/50	Linear (LIN) Dimming, supplied with leads for 0-10V control, 2x2 Aculux Lini Module
	ZT	DARK	S370LM	eldoLED SOLODrive 30/50	Logarithmic (LOG) Dimming, supplied with leads for 0-10V control, 1x2 Aculux Lini Module
	ZT	DARK	S740LM	eldoLED SOLODrive 30/50	Logarithmic (LOG) Dimming, supplied with leads for 0-10V control, 2x2 Aculux Lini Module
	NLIGHT	MINIO	S370LM	eldoLED SOLODrive 30/50	Linear (LIN) Dimming, internal NIO EZ PH J100 included with luminaire, 1x2 Aculux Lini Module
	NLIGHT	MINIO	S740LM	eldoLED SOLODrive 30/50	Linear (LIN) Dimming, internal NIO EZ PH J100 included with luminaire, 2x2 Aculux Lini Module
	NLIGHT	MINI	S370LM	eldoLED SOLODrive 30/50	Linear (LIN) Dimming, internal NIO EZ PH J100 included with luminaire, 1x2 Aculux Lini Module
	NLIGHT	MINI	S740LM	eldoLED SOLODrive 30/50	Linear (LIN) Dimming, internal NIO EZ PH J100 included with luminaire, 2x2 Aculux Lini Module
	NLIGHT	DARK	S370LM	eldoLED SOLODrive 30/50	Logarithmic (LOG) Dimming, internal NIO EZ PH J100 included with luminaire, 1x2 Aculux Lini Module
	NLIGHT	DARK	S740LM	eldoLED SOLODrive 30/50	Logarithmic (LOG) Dimming, internal NIO EZ PH J100 included with luminaire, 2x2 Aculux Lini Module
DALI	DARK	S370LM	eldoLED SOLODrive 30/50	Logarithmic (LOG) Dimming, DALI controls by others	
DALI	DARK	S740LM	eldoLED SOLODrive 30/50	Logarithmic (LOG) Dimming, DALI controls by others	

UL924 Sequence of Operation
<p>The below information applies to all nLight AIR devices an EM option.</p> <ul style="list-style-type: none"> EM devices will remain at their high-end trim and ignore wireless lighting control commands, unless a normal-power-sensed (NPS) broadcast is received at least every 8 seconds. Using the CLAIRITY+ mobile app, EM devices must be associated with a group that includes a normal power sensing device to receive NPS broadcasts. Only non-emergency rPP20, rLSXR, rSBOR, rSDGR, and nLight AIR luminaires with version 3.4 or later firmware can provide normal power sensing for EM devices. See specification sheets for control devices and luminaires for more information on options that support normal power sensing.

nLight® Wired Control Accessories <i>Order as separate catalog number</i>	
Wall Switches	Model Number
On/Off single pole	nPODMA (color)
On/Off two pole	nPODMA 2P (color)
On/Off single pole, dimming	nPODMA DX (color)
On/Off two pole, dimming	nPODMA 2P DX (color)
On/Off, two level	nPODMA 2L (color)
Graphic touchscreen	nPOD TOUCH (color)

For more information see [nPODMA](#) and [nPOD TOUCH](#) spec sheets.

nLight® Wired Control Accessories <i>Order as separate catalog number</i>	
Wall Switches	Model Number
On/Off single pole	rPODBA (color)
On/Off two pole	rPODBA 2P (color)
On/Off single pole, dimming	rPODBA DX (color)
On/Off two pole, dimming	rPODBA 2P DX (color)
On/Off, 4 scene control	rPODBA 4S (color)

For more information see [rPODBA](#) spec sheets

INTEGRATED SENSOR & LAYOUT

Only one sensor per zone allowed. At the most, the entire run can only have 2 sensors designated. Sensor zone cannot split a fixture section or overlap of zones. Sensors will be located on a Left end or Right end of fixture section. Default location for first sensor is Left end and default location for second sensor is Right end.

CORRECT:

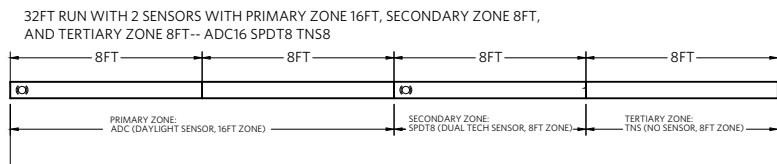
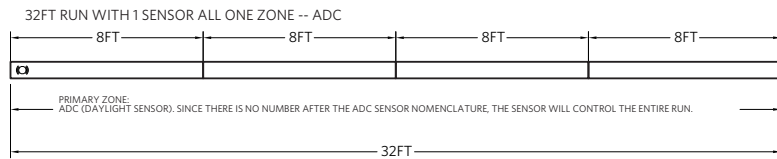
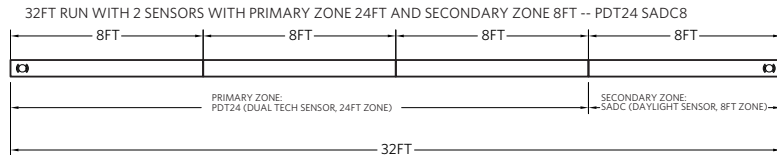

INCORRECT:

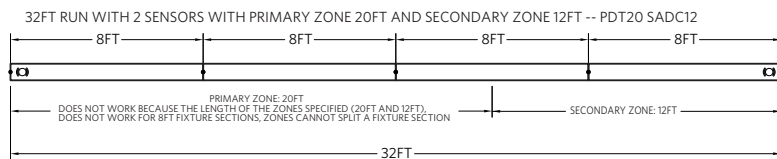
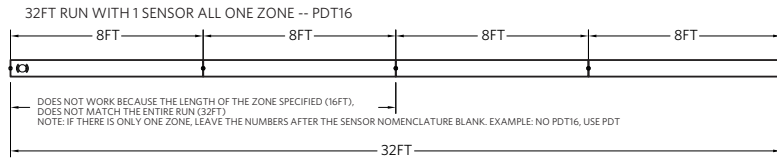

For runs longer than 8FT:
ALWAYS order the run by the TOTAL RUN LENGTH. Ordering the sections individually will not provide the correct joining hardware to allow connection in the field.

OCCUPANCY DETECTION COVERAGE

At the 7.5 ft (2.29 m) hanging height of a typical pendant mount fixture the sensor provides 10 ft (3.05 m) radial detection of small motion. At a 9 ft (2.74 m) hanging height the radius is 12 ft (3.66 m) for small motion.

Adequate for walking motion detection from mounting heights between 7.5 ft (2.29 m) and 20 ft (6.10 m).

Initial detection will occur earlier when walking across sensor's field of view than when walking directly at sensor.

Initial detection of walking motion into long coverage segment will occur at distances of 2x the mounting height up to 15 ft (4.57 m) and 1.75x up to 20 ft (6.10 m). Lens assembly rotates 15° to enable adjustment in order to line up long segments.

Tested to NEMA WD 7-2011

SENSOR & SENSOR PLATE DETAIL

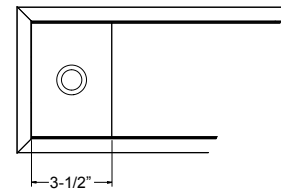
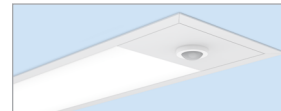

Sensor	Control Input			
	ZT	NLIGHT	NLTAIR2	NLTAIR2 w/ EC or GTD
ADC	MSD EZ ADC	NES ADCX	n/a	n/a
APDT	MSD PDT 7 EZ ADC	NES PDT 7 ADCX	RES7 PDT ZTS EXT900 ACWH 90D G2	RES7 PDT ZT EM EXT900 ACWH 90D G2
APIR	MSD 7 EZ ADC	NES 7 ADCX	RES7 ZTS EXT900 ACWH 90D G2	RES7 ZT EM EXT900 ACWH 90D G2
PDT	MSD PDT 7 EZ	NES PDT 7	n/a	n/a

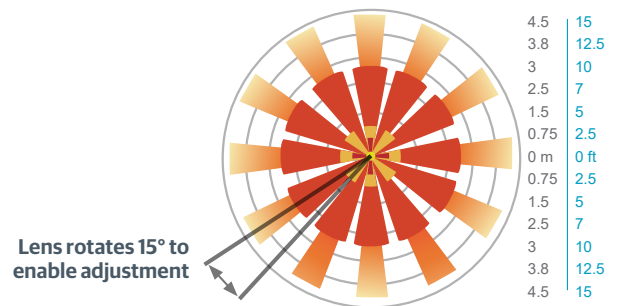

INTEGRATED CONTROLS

Optional nLight® integrated controls make Slot LED luminaires addressable- allowing them to digitally communicate with other nLight enabled controls such as dimmers, switches, occupancy sensors and photocontrols. Simply connect all the nLight enabled control devices using standard CAT5 Cabling (by others).

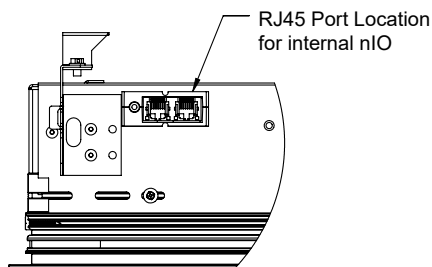

Note: Only one nLight device (rIO/nIO) per zone allowed.

nLight Air Wireless Antenna Detail

Note: Antenna will be shipped separately and will need to be attached to the coax base.

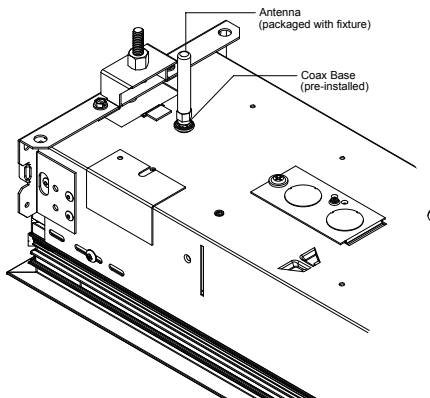
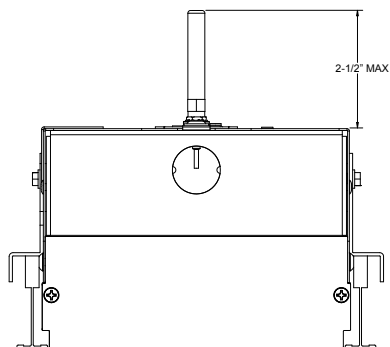

ADDITIONAL OPTIONS

Prewire Whip (PWS)

6-foot long, 3/8" diameter, (3) or (5) 18-gauge wire, 1-circuit Fixtures with PWS Option have conduit with preinstalled wires. Conduit is packed inside the same box as the fixture and it needs to be installed on the fixture by installation contractor.

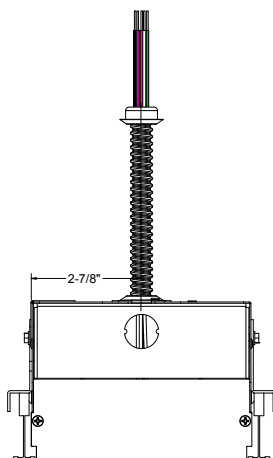

Wet Location (WL)

- * Wet location fixtures can be recognized by the reflector end cap which is already installed into the fixture.
- * Wet location fixtures are available as individual fixture sections starting at 2FT through 8FT maximum run length.
- * Wet location is suitable for covered ceiling mount installation only, where any water exposure is from beneath the non-porous mount surface.
- * Lens is not sealed or gasketed.

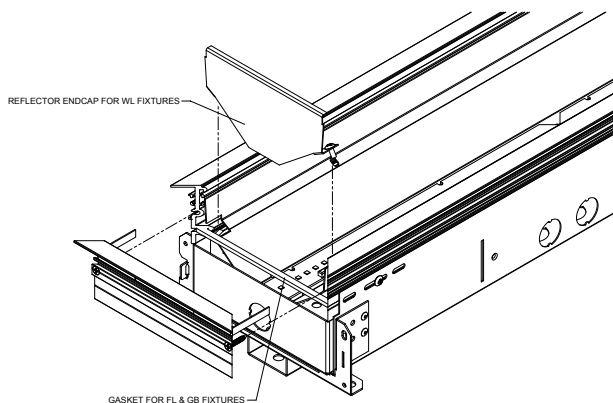

EMERGENCY OPTIONS

Emergency Battery Pack

The [PS1055LCP](#) battery is integral or remote to the fixture and comes standard with test switch and self-diagnostics. Standard emergency operation as indicated below.

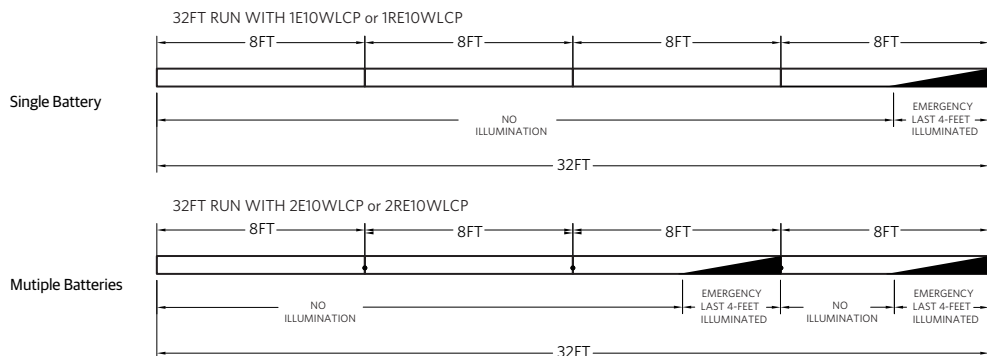

Emergency Circuits

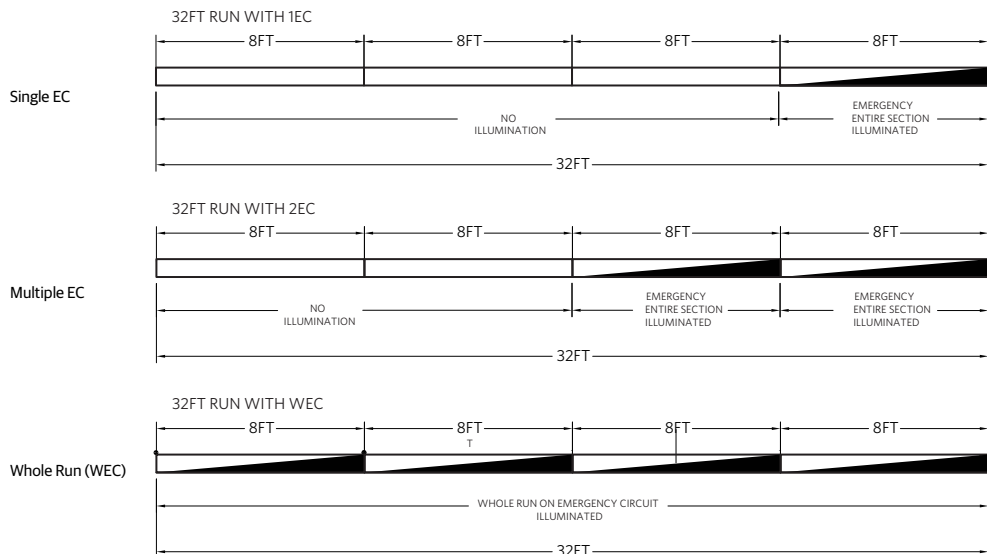

How to Estimate Delivered Lumens in Emergency Mode (E10WLCP or RE10WLCP)
Use the formula below to estimate the delivered lumens in emergency mode

Delivered Lumens = 1.25 x P x LPW
P = 10W for PS1055LCP
LPW = Lumen per watt rating of the luminaire (Available on page 1 of this spec sheet or appropriate IES file.)
(Available on page 1 of this spec sheet or appropriate IES file.)

Per tested performance data, maximum mount height of 17-feet calculated to achieve 1 footcandle (10.8 lux) of illumination below emergency battery powered fixture on the path of egress. (Based on fixture tested with 90CRI 27K LED.)

Section Length	Control Input		
	Integral (E10WLCP)	Remote (RE10WLCP)	EC
U2-U2/11.875	n/a	Entire Section Length	Entire Section Length
U3-U3/11.875	n/a	Entire Section Length	Entire Section Length
U4	Entire Section Length	Entire Section Length	Entire Section Length
U4/0.125-U4-11.875	n/a	Last 2-feet of Section Length	Entire Section Length
U5-U5/11.875	Last 3-feet of Section Length	Last 3-feet of Section Length	Entire Section Length
U6-U6/11.875	Last 3-feet of Section Length	Last 3-feet of Section Length	Entire Section Length
U7-U7/11.875	Last 4-feet of Section Length	Last 4-feet of Section Length	Entire Section Length
U8	Last 4-feet of Section Length	Last 4-feet of Section Length	Entire Section Length

Integral Emergency Test Switch

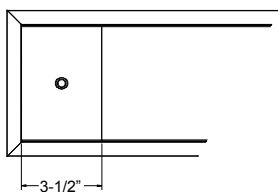
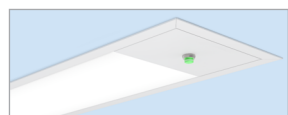

EMERGENCY OPTIONS (Continued)

Remote Emergency Battery Pack

10w linear constant power emergency LED driver is remote mounted from the luminaire. The emergency driver switches power from the normal AC driver and operates the fixture for 90 minutes in the emergency mode from the unit's battery supply. Consists of (1) emergency LED driver within (1) remote mounting enclosure, flexible conduit, test switch, indicator light, cover plate and junction box supplied.

Maximum remote mounting distance from test switch to fixture not to exceed 25-feet.

The maximum emergency remote distance recommended by the manufacturer is 25-feet with 18 AWG wires.

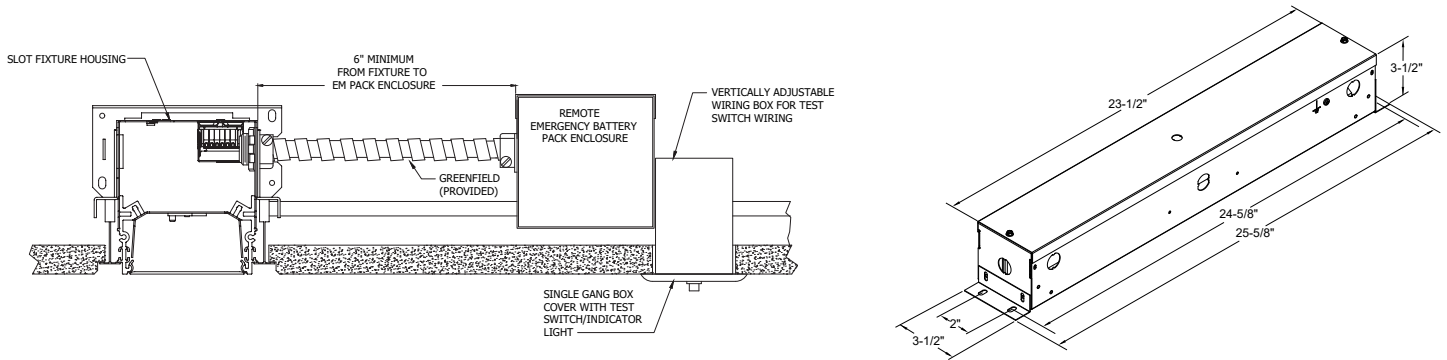

Remote GTD Mounting Option

Emergency generator transfer device is remote mounted from the luminaire. The generator transfer device senses the loss of normal AC power and switches the LED driver input power connection to an unswitched, generator (or central inverter) supplied lighting circuit bypassing the fixture wall switch. Consists of (1) emergency generator transfer device within (1) remote mounting enclosure with 6-foot long flexible conduit.

Maximum remote mounting distance is 6 feet from fixture.

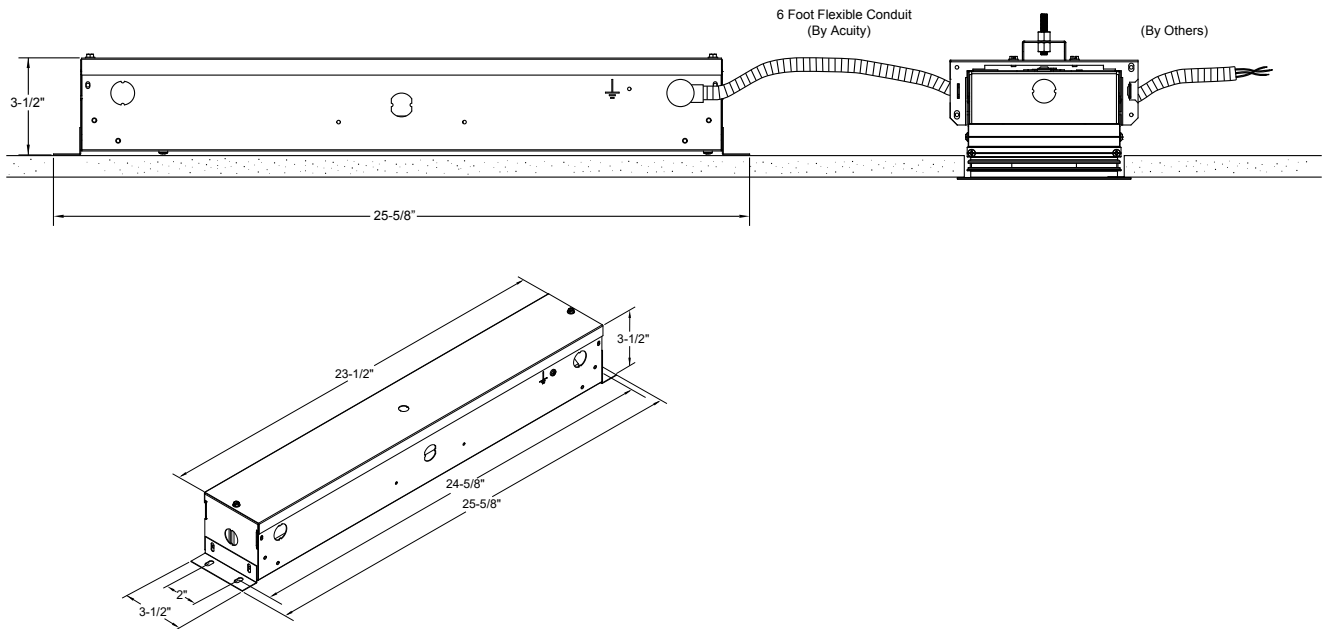

SPECIFICATIONS

Housing

Nominal 6" x 2', 3', 4', 5', 6', 7', 8' and continuous rows in 1/8" increments starting at 2', as standard. Upper housing fabricated from cold-rolled steel with extruded aluminum ceiling trim.

Finish

Standard colors for fixture trims are polyester powder coated white, anti-microbial white, black, or silver with satin sheen. Consult factory for custom colors or specify RAL colors from Architectural brochure.

Reflector

Precision-formed steel; high reflectance matte white powder coat; 93% reflectivity.

Optics (Distribution)

Direct Batwing (DBW) and Direct Asymmetric (DAS) incorporate co-extruded lenses and films.

Lenses/Shielding

Extruded acrylic lens, (CLL, FLL).

Mounting

Sheetrock: Recessed ceiling only to accommodate sheetrock, 1/2" minimum to 1-1/2" maximum depth for FL, GB, FLINB or GBINB trim options. Grid: To accommodate 9/16" Flat Tee with Lay-In Tile, 9/16" Flat Tee with Tegular Tile, 9/16" Slot Tee with Tegular Tile, 15/16" Flat Tee with Lay-In Tile, & 15/16" Flat Tee with Tegular Tile.

LED Source

Multiple lumen packages available with 2700K, 3000K, 3500K, 4000K, and 5000K CCT in 90CRI. The Acuity Brands circuit boards for the linear LED components use a precise binning algorithm which creates a consistent color temperature from board to board. Color variation of no greater than a 2.5 Step MacAdam (2.55DECM) along the black body locus from board to board.

Electrical

Long-life LEDs, coupled with high-efficiency drivers, provide superior quantity and quality of illumination for extended service life. 90% LED lumen maintenance at 60,000 hours (L90/60,000).

Circuits

Single and dual switching options available. Dual switching offered with shared neutral when downlights are specified.

Dimming Driver

Factory tuned constant current electronic dimming driver is standard. Flicker free dimming available down to <1%. LED drivers perform within the recommended operating areas for flicker as a function of frequency and modulation (%) IEEE Standard 1789-2015 (IEEE Recommended Practices for Modulating Current in High-Brightness LEDs for Mitigating Health Risks to Viewers), in typical operating conditions at representative dimming levels. Electrical specifications at maximum driver load: PF > 0.9 and THD <20%. Meets FCC Title 47 Class A or Class B. Other available drivers include Lutron and DALI protocol drivers. All drivers are RoHS compliant.

Controls System Networking Options

Optional integrated nLight® controls make each fixture addressable - allowing it to digitally communicate with other nLight enabled controls such as dimmers, switches, occupancy sensors, and photocontrols. Connection to nLight is simple. It can be accomplished with remote nLight AIR wireless or through standard Cat-5 cabling. (cabling "by others") nLight offers unique plug-and-play convenience as devices and luminaires automatically discover each other, while nLight AIR is commissioned easily through an intuitive mobile app.

Emergency Battery (Optional)

Integral emergency battery (E10WLCP) for 90 minutes of operation. Emergency battery pack, 10W, Linear Constant Power Certified in CA Title 20 MAEDBS. Integrated test switch and indicator light. Remote emergency battery (RE10WLCP) for 90 minutes of operation. Emergency battery pack, 10W, Linear Constant Power Certified in CA Title 20 MAEDBS. Remote enclosure, flexible conduit, test switch, indicator light, cover plate and junction box supplied. Remote generator transfer device (GTD) works in conjunction with an auxiliary generator or a central inverter system to power fixtures for safe egress lighting.

Ambient Operating Temperature Range

-20°C (-4° F) to +25°C (+77°F)

Environment

Suitable for damp location. Indoor use only. Optional Wet (WL) location exterior use available with specified nomenclature.

Certification

CSA certified to meet U.S. and Canadian standards (UL1598 and UL8750). This product is IC rated. Optional Wet (WL) location listing available with specified nomenclature. Wet location listing is suitable for covered ceiling mount installation only, where any water exposure is beneath the non-porous mount surface.

Fixture Weight

Approximately 6.0 lbs per foot, less packaging.

Government Procurement

BAA - Buy America(n) Act: Product qualifies as a domestic end product under the Buy American Act as implemented in the FAR and DFARS. Product also qualifies as manufactured in the United States under DOT Buy America regulations.

BABA - Build America Buy America: Product qualifies as produced in the United States under the definitions of the Build America, Buy America Act.

Please refer to www.acuitybrands.com/buy-american for additional information.

Warranty

5-year limited warranty. This is the only warranty provided and no other statements in this specification sheet create any warranty of any kind. All other express and implied warranties are disclaimed. Complete warranty terms located at: www.acuitybrands.com/support/warranty/terms-and-conditions

Notes: Actual performance may differ as a result of end-user environment and application.

All values are design or typical values, measured under laboratory conditions at 25 °C.

Specifications subject to change without notice.