

Pathfinder

Patient Room LED Night Light



Project:

Type:

Qty:

SPECIFICATIONS

Interior Patient Room LED Night Light

HNL600

SPECIFICATIONS

The low-profile recessed design of the Pathfinder makes it a popular choice for night lighting when the intent is to blend the fixture into the wall. The louver design is engineered to maximize light output with clean cut-off, delivering sufficient light to navigate a darkened room but minimizing disruption of a sleeping patient. Dependable LED lighting will provide years of energy-efficient and maintenance-free operation. Choose from (3) standard white, amber, blue, or red LED options. An integral photocell (option) may be specified for additional energy efficiency.

Also available with through wall option where second pathfinder (satellite) can be mounted on reverse side of wall and powered by master pathfinder box via low voltage wire. Satellite pathfinder can be installed up to two feet away from master pathfinder.

Faceplate

Heavy gauge steel.
Available in multiple colors and materials.

Backbox

Galvanized with folded, welded corners and mounting tabs.

Source

High output LED board

Switching

Line voltage switching (by others)

Weight

HNL610 2 lbs
HNL612 3 lbs

Mounting

Installed in rectangular cutout in wall for both HNL610 and HNL612

Voltage

MVOLT – 120-277V

Light Output (As Tested)

LED30 = 39 Lumens
LED40 = 44 Lumens
LED50 = 44 Lumens
LEDAMB = 31 Lumens
LEDBL = 8 Lumens
LEDRD = 13 Lumens

Input Watts (As Tested)

All LED Colors = 1.20 Watts

Color Temperature Options

CCT: 3000K, 4000K, 5000K
Color: Amber, Blue (470nm), Red (625nm)

Color Quality

>80 CRI

LED Life Estimate

50,000 hours
LED Life projection is based on IES TM-21 and IES LM-80

Listing

UL Certified to meet US and Canadian standards. Suitable for damp locations.

Government Procurement

BAA – Buy America(n) Act: Product qualifies as a domestic end product under the Buy American Act as implemented in the FAR and DFARS. Product also qualifies as manufactured in the United States under DOT Buy America regulations.

BABA – Build America Buy America: Product qualifies as produced in the United States under the definitions of the Build America, Buy America Act.

Please refer to www.acuitybrands.com/resources/buy-american for additional information.

Warranty

5-year limited warranty. Complete warranty terms located at www.AcuityBrands.com/CustomerResources/Terms_and_Conditions.aspx

NOTE: Actual performance may differ as a result of end-user environment and application.

All values are design or typical values, measured under laboratory conditions at 25°C.

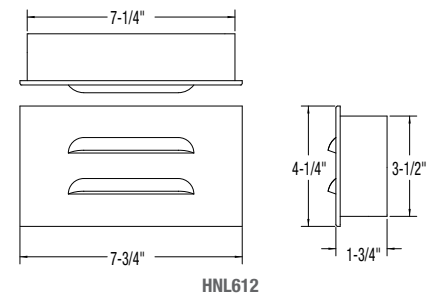
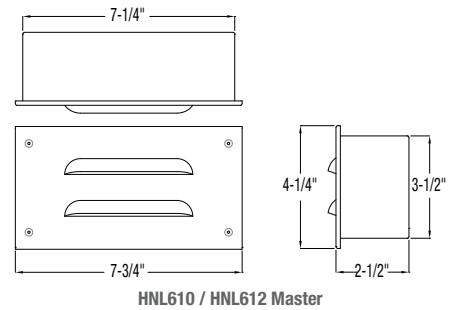

Fixture	Width (in.)	Height (in.)	Depth (in.)
FACEPLATE	7 3/4"	4 1/4"	NA
HNL610 BACKBOX	7 1/4"	3 1/2"	2 1/2"
HNL612 BACKBOX (2nd fixture)	7 1/4"	3 1/2"	1 3/4"

CATALOG NUMBER

Example: HNL610 MVOLT LED40 PC AM

Series	Voltage	LED Color	Options	Finish
HNL610 Single Face HNL612 Double Face	MVOLT 120-277 Volt	LED30 3000k Warm White LED40 4000k Neutral White LED50 5000k Cool White LEDAMB Amber 585-595nm LEDBL Blue 470nm LEDRD Red 625nm	PC Integrated Photocell TR Tamper Resistant Screws	(blank) Flat White AM Anti-Microbial White MB Matte Black SS Stainless Steel

Pathfinder

Patient Room LED Night Light

Project:

Type:

Qty:

SPECIFICATIONS

Interior Patient Room LED Night Light

HNL600

PERFORMANCE DATA

Lumen Output

Lumen values are from photometric tests from an accredited laboratory. Data is considered to be representative of the configurations shown, within generally accepted industry tolerances. Contact factory for performance data on any configurations not shown here.

Fixture	Lumen Output (lm)	Max Candela	Input Watts
HNL610 LED30	39	36	1.20
HNL610 LED40	44	39	1.20
HNL610 LED50	44	40	1.20
HNL610 LEDAMB	31	29	1.20
HNL610 LEDBL	8	7	1.20
HNL610 LEDRD	13	11	1.20

PHOTOMETRICS

Test Report: ISF 192506
Model: HNL610 MVOLT LED30 AM
Lumen Output: 39.3
Input Watt: 1.15
Efficacy: 34.17 L/W
Max. Candela: 36.0 @ H: 0°, V: 45.0°

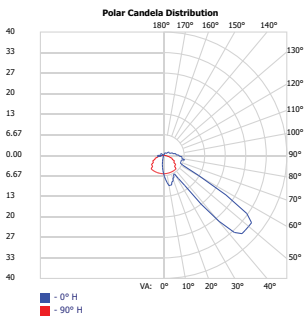

Test Report: ISF 192507
Model: HNL610 MVOLT LED40 AM
Lumen Output: 44.2
Input Watt: 1.15
Efficacy: 38.44 L/W
Max. Candela: 39.3 @ H: 0°, V: 45.0°

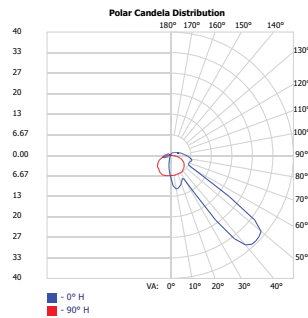

Test Report: ISF 192508
Model: HNL610 MVOLT LED50 AM
Lumen Output: 44.5
Input Watt: 1.15
Efficacy: 38.70 L/W
Max. Candela: 40.0 @ H: 0°, V: 42.5°

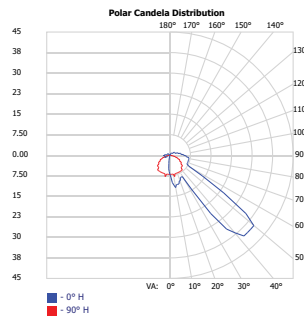

Test Report: ISF 192519
Model: HNL610 MVOLT LEDAMB AM
Lumen Output: 31.2
Input Watt: 1.14
Efficacy: 27.37 L/W
Max. Candela: 29.0 @ H: 0°, V: 42.5°

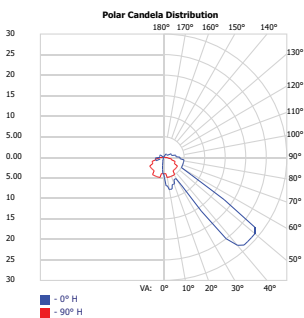

Test Report: ISF 192510
Model: HNL610 MVOLT LEDBL AM
Lumen Output: 8.4
Input Watt: 1.16
Efficacy: 7.24 L/W
Max. Candela: 7.1 @ H: 0°, V: 40.0°

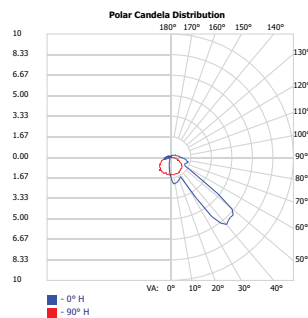

Test Report: ISF 192511
Model: HNL610 MVOLT LEDRD AM
Lumen Output: 13.1
Input Watt: 1.19
Efficacy: 11.01 L/W
Max. Candela: 11.4 @ H: 22.5°, V: 47.5°

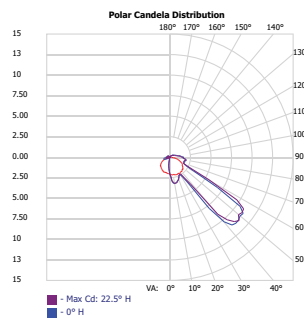

Photometric data based on test results from an independent NIST traceable testing lab. IES data is available at www.healthcare-lighting.com. Always refer to our website for the latest IES file updates.

Pathfinder

Patient Room LED Night Light

Project:

Type:

Qty:

SPECIFICATIONS

Interior Patient Room LED Night Light

HNL600

MOUNTING

NOTES

- Ensure power is off before wiring fixture.
- Use sheet rock screws (4) to secure backbox to wall.
- All wiring must be in accordance with all local, state, and federal electrical codes.
- Recommend that a trained and certified electrician install product.

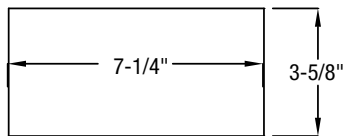

WALL CUTOUT

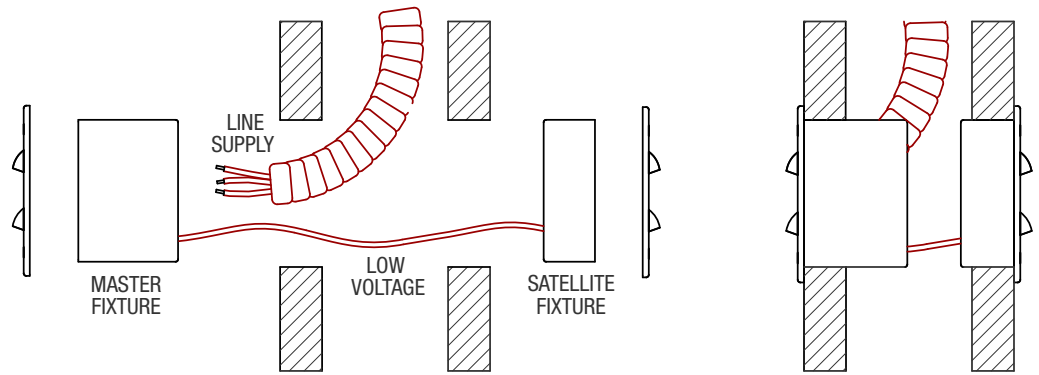

HNL612 MOUNTING