

# SLOT 2

PERIMETER  
TUNABLE WHITE  
DC2DC ARCHITECTURE

## HIGHLIGHTS

- Compact profile
- Uniform illumination along wall surface
- Extruded aluminum and sheet metal construction
- Regressed snap-in acrylic lens
- Field adjustable telescopic end, up to 12 inches
- Driver options for Dim to Dark
- White, black or silver paint with satin finish
- UGR data available on page 4.



## FIXTURE PERFORMANCE

Nominal Lumens/Foot	Direct*											
	300LMF			400LMF			600LMF			800LMF		
CCT	27K	46K	65K	27K	46K	65K	27K	46K	65K	27K	46K	65K
Delivered Lumens/Foot	280	287	287	380	376	383	580	555	576	780	734	769
DC Input Watts/Foot**	2.35	2.33	2.33	3.24	3.02	3.15	5.01	4.43	4.82	6.80	5.82	6.47
Lumens/Watt	119	123	123	117	124	121	116	125	120	115	126	119

Nominal Lumens/Foot	Direct*		
	1000LMF		
CCT	27K	46K	65K
Delivered Lumens/Foot	979	913	962
DC Input Watts/Foot**	8.57	7.23	8.14
Lumens/Watt	114	126	118

\*Based on a 4FT 90CRI TUWH RHYR (27K-65K) fixture with 2" depth lens regress (2D), standard lambertian distribution, and flush lens (FLL)

\*\*Standard photometry based on AC wattage, DC wattage = AC wattage \* .93

**Note:** See Page 6 for Device Addresses and Feed details.



## DIRECT DISTRIBUTION

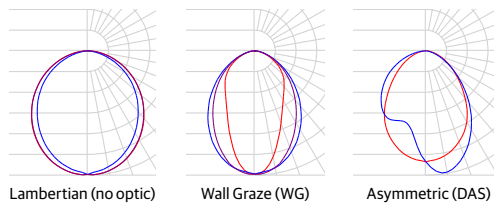

## DIMENSIONS

FL Trim with 2D Lens Regress

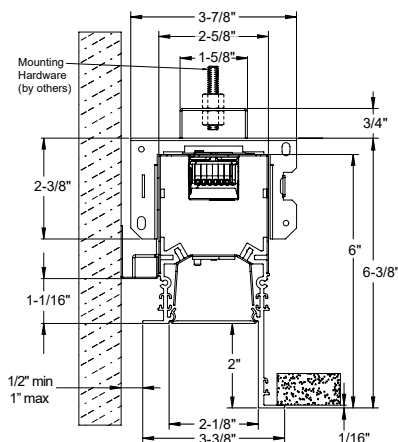

## DIFFUSERS/SHIELDING

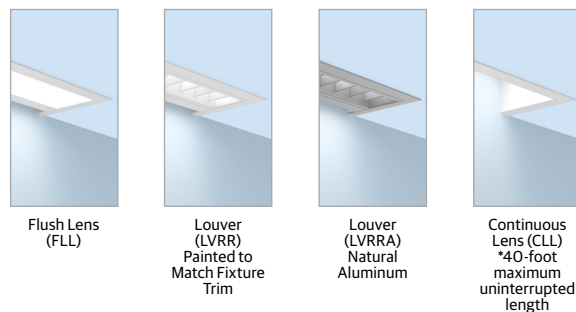

**ORDERING**

Example: S2CD LOP 8FT OD TG 90CRI TUWH RHYR 600LMF WG SCT DARK FLL 57VDC SLVT DALI8 P2P

--	--	--	--	--	--

Series	Linear Plan	Total Run Length	Lens Regress Depth	Mounting	Ceiling Type
<b>S2CD</b> Slot 2 Perimeter Direct	<b>LOP</b> Optimized Length	<b>_FT_</b> Specify continuous linear feet to nearest 1/8" increments starting at 2FT (Example 24' - 6 1/8" = 24FT6.125) <b>_FT'</b> Specify continuous linear feet to whole foot increments starting at 2FT (Example: 24' = 24FT) Unit length may affect available options. <b>For runs longer than 8FT: ALWAYS order the run by the TOTAL RUN LENGTH. Ordering the sections individually will not provide the correct joining hardware to allow run connections in the field.</b> 1. Use whole foot increment when using ADJS, LVRR, LVRRRA, or zoning options.	<b>OD</b> 0" Depth <b>1D'</b> 1" Depth <b>2D'</b> 2" Depth 1. Not available with Direct Distribution options.	<b>&lt;blank&gt;</b> Fixed Length <b>ADJS<sup>1,2</sup></b> Field Adjustable (+0/-12") Section at End of Run 1. Supplied as a 4, 6, 7, or 8-foot individual or section at end of run. Left end is field trimmed to length. 2. Not available with DAS, WG or CP options in entire run.	<b>FL</b> 5/8IN Flange (sheetrock) <b>TG</b> Grid Ceiling: 9/16" Flat Tee with Lay-In Tile, 9/16" Flat Tee with Tegular Tile, 9/16" Slot Tee with Tegular Tile, 15/16" Flat Tee with Lay-In Tile, & 15/16" Flat Tee with Tegular Tile

--	--	--	--	--	--

Direct Light Source Color Rendering	Direct Dynamic Feature	Direct Dynamic Range	Direct LED Light Output	Direct Distribution <sup>1</sup>	Switching
<b>90CRI</b> 90CRI	<b>TUWH</b> Tunable White	<b>RHYR</b> Rhythm Range (2700K-6500K)	<b>300LMF</b> 300 Lumens per Foot <b>400LMF</b> 400 Lumens per Foot <b>600LMF</b> 600 Lumens per Foot <b>800LMF</b> 800 Lumens per Foot <b>1000LMF</b> 1,000 Lumens per Foot <b>_LMF</b> Specify Lumens between 300LMF and 1000LMF in 50LMF increments	<b>&lt;blank&gt;</b> Lambertian <b>DAS</b> Direct asymmetric distribution <b>WG</b> Wall Graze Distribution 1. Direct Distribution options are only available with FLL Direct Shielding and OD Lens Regress Depth option.	<b>SCT</b> Single Circuit

--	--	--	--	--	--

Minimum Dimming Level	Optional Shielding	Voltage	Finish	Emergency Battery Packs	Control Input
<b>DARK</b> Constant Current, Dimming to 0.1%	<b>CLL<sup>3,5</sup></b> Continuous Flush Lens <b>FLL<sup>4</sup></b> Flush Lens <b>LVRR<sup>1,2</sup></b> Louver (painted same finish color as housing) <b>LVRRRA<sup>1,2</sup></b> Natural Aluminum Louver 1. Not available with TG trim. 2. Only available in whole foot increments. 3. CLL is not available with DAS or WG distributions. 4. When using distribution options, FLL will change to FLLC to designate a co-extruded lens with white and clear material. 5. 40-foot maximum uninterrupted length.	<b>57VDC</b> 57VDC, Class 2 Only	<b>WHIT</b> White (Satin) <b>AMF</b> Antimicrobial White <b>BLKT</b> Black (Satin) <b>SLVT</b> Silver (Satin) <b>RALTB<sup>1</sup>D</b> <a href="#">RAL Paint Finish</a> 1. RALTB <sup>1</sup> D is for pricing only. Replace with applicable RAL number & sheen when placing order	<b>&lt;blank&gt;</b> No Emergency Option <b>_EC</b> Total Number of Emergency Circuits	<b>DALI8</b> eldoLED Driver TWD T8

--	--	--	--	--

END Option	Primary Zone <sup>1</sup>	Secondary Zone <sup>1</sup>	Tertiary Zone Indicator <sup>1</sup>	Options
<b>W2W</b> Wall to Wall (Both Ends Terminate at Wall)	<b>&lt;blank&gt;</b> No Primary Zone	<b>&lt;blank&gt;</b> No Secondary Zone	<b>&lt;blank&gt;</b> No Tertiary Zone	<b>&lt;blank&gt;</b> No Options
<b>P2P</b> Pocket to Pocket (Both Ends Terminate at Ceiling)	<b>NS_</b> Primary Zone (Specify zone length in feet.)	<b>SNS_</b> Secondary Zone (Specify zone length in feet.)	<b>TNS_</b> Tertiary Zone (Specify zone length in feet.)	<b>CP<sup>1</sup></b> Chicago Plenum
<b>N2N</b> No Show Wall to No Show Wall (Both Ends Terminate at Wall)	1. Available in whole foot run length.	1. Available in whole foot run length.	1. Available in whole foot run length.	1. Not available in a run with ADJS option.
<b>W2P</b> Wall to Pocket (Start Terminates at Wall & End Terminates at Ceiling)				
<b>P2W</b> Pocket to Wall (Start Terminates at Ceiling & End Terminates at Wall)				
<b>N2P</b> No Show Wall to Pocket (Start Terminates at Wall & End Terminates at Ceiling)				
<b>P2N</b> Pocket to No Show Wall (Start Terminates at Ceiling & End Terminates at Wall)				
<b>N2W</b> No Show Wall to Wall (Both Ends Terminate at Wall)				
<b>W2N</b> Wall to No Show Wall (Both Ends Terminate at Wall)				

**PHOTOMETRICS**

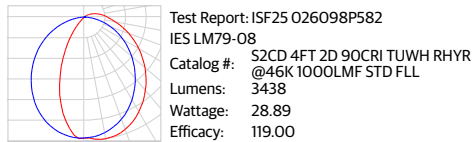
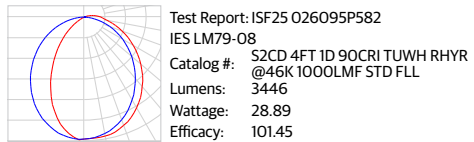
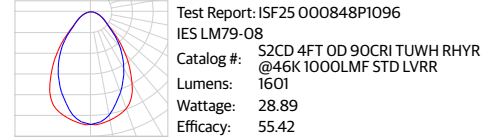
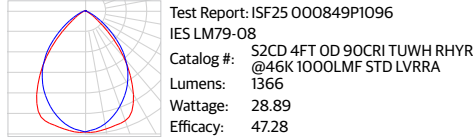
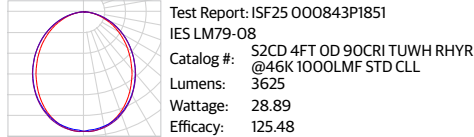
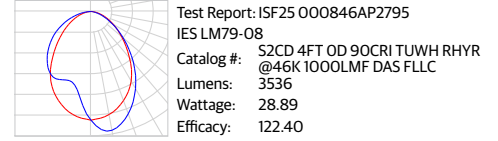
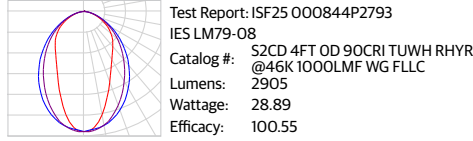
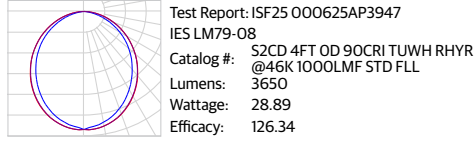

**PROJECT LED LUMEN MAINTENANCE**

Data references the extrapolated performance projections for the platforms noted in a 25°C ambient, based on 10,000 hours of LED testing (tested per IESNA LM-80-08 and projected per IESNA TM-21-11).  
To calculate LLF, use the lumen maintenance factor that corresponds to the desired number of operating hours below. For other lumen maintenance values, contact factory.

<b>Operating Hours</b>	0	10,000	60,000	100,000
<b>Lumen Maintenance Factor</b>	1	0.98	0.84	0.75

**REGRESS DEPTH SCALING CHART**

LENS REGRESS DEPTH	MULTIPLIER
OD	1.00
1D	0.90
2D	0.94

\*Base fixture with Lambertian distribution, 0° depth lens regress (OD), and flush lens (FLL)

**OPTICAL SCALING CHARTS**

DISTRIBUTIONS	MULTIPLIER
LAMBERTIAN	1.00
DAS	0.97
WG	0.80
SHIELDING	MULTIPLIER
LVRR	0.44
LVRRA	0.37
CLL	0.99
FLL	1.00

\*Base fixture with Lambertian distribution and flush lens (FLL)

**50LMF INCREMENT SCALING CHART**

NOMINAL LMF	LUMEN MULTIPLIER	WATTAGE MULTIPLIER
300LMF	0.31	0.30
350LMF	0.36	0.35
400LMF	0.41	0.40
450LMF	0.46	0.45
500LMF	0.52	0.50
550LMF	0.57	0.54
600LMF	0.62	0.59
650LMF	0.67	0.64
700LMF	0.72	0.69
750LMF	0.76	0.75
800LMF	0.81	0.80
850LMF	0.86	0.85
900LMF	0.91	0.90
950LMF	0.96	0.95
1000LMF	1.00	1.00

\*Base fixture with 0° depth lens regress (OD), standard lambertian distribution, flush lens (FLL), and 1000LMF

**TUNABLE WHITE GAMUT AND RANGE**

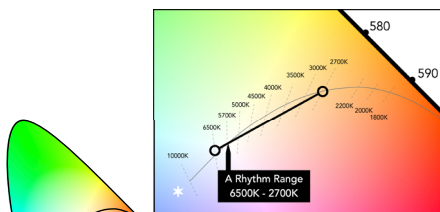

**A Rhythm Range 6500K to 2700K**

- Tunable White GPHD**
- Gamut: One-dimensional Warm-Cool (W/C)
  - Path: Single-segment 6500K to 2700K (Rhythm Range)
  - Handle: Two natural language handles: Intensity and CCT
  - Data: nLight with nTune technology for both handles of control

**UGR CHART**

Lumen Package	UGR (70% 50% 20% reflectance using a 4H x 8H room size)													
	Crosswise													
	OD FLL Lambertian	OD CLL Lambertian	OD WG	OD DAS	OD LVRR	OD LVRRRA	1D FLL Lambertian	1D CLL Lambertian	1D LVRR	1D LVRRRA	2D FLL Lambertian	2D CLL Lambertian	2D LVRR	2D LVRRRA
300LMF	21.6	21.9	19.9	19.3	15.1	10.5	21.3	21.3	18.4	17.9	22	22	19.1	18.6
400LMF	22.6	22.9	20.9	20.7	16.1	11.5	22.3	22.3	19.4	18.9	23	23	20.1	19.6
600LMF	24	24.3	22.3	21.7	17.5	12.9	23.7	23.7	20.8	20.3	24.4	24.4	21.5	21
800LMF	25	25.3	23.3	22.4	18.4	13.8	24.6	24.6	21.8	21.2	25.4	25.3	22.5	21.9
1000LMF	25.7	26	24	23	19.2	14.5	25.4	25.3	22.5	22	26.1	26.1	23.2	22.7
Lumen Package	Endwise													
	OD FLL Lambertian	OD CLL Lambertian	OD WG	OD DAS	OD LVRR	OD LVRRRA	1D FLL Lambertian	1D CLL Lambertian	1D LVRR	1D LVRRRA	2D FLL Lambertian	2D CLL Lambertian	2D LVRR	2D LVRRRA
	300LMF	22.5	21.2	19.1	21	14.4	5.2	25.1	25.1	22.3	21.7	26.7	26.7	23.8
400LMF	23.5	22.2	20.1	22.4	15.4	6.2	26.1	26.1	23.3	22.7	27.7	27.7	24.8	24.3
600LMF	24.9	23.6	21.5	23.3	16.8	7.6	27.5	27.5	24.7	24.1	29.1	29.1	26.2	25.7
800LMF	25.9	24.5	22.4	24	17.8	8.5	28.5	28.5	25.6	25.1	30.1	30	27.2	26.6
1000LMF	26.6	25.2	23.1	24.7	18.5	9.2	29.2	29.2	26.4	25.8	30.8	30.8	27.9	27.4

\*UGR varies based on luminaire options and is affected by application dependent parameters. Numbers depicted here are considered "Luminaire-UGR" and/or "Point-UGR" values. To determine a more precise maximum UGR value ("Application-UGR"), a full lighting design layout should be completed with the selected luminaire configuration for each application.

\*\*Click here for more information on: [UGR FAQ](#)

**CEILING TRIMS**

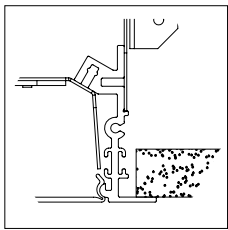

**FL**  
5/8IN Flange (sheetrock)  
Install Before Sheetrock

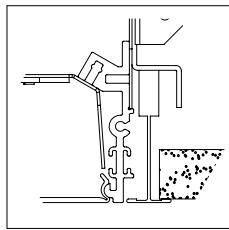

**TG**  
9/16" Flat Tee w/ Lay-in Tile

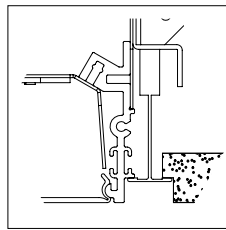

**TG**  
9/16" Flat Tee w/ Tegular Tile

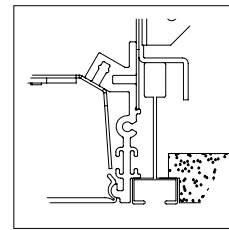

**TG**  
9/16" Slot Tee w/ Tegular Tile

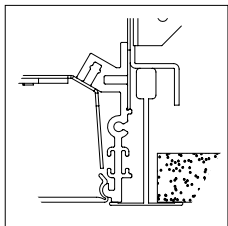

**TG**  
15/16" Flat Tee w/ Lay-in Tile

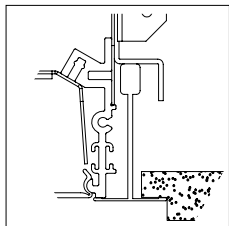

**TG**  
15/16" Flat Tee w/ Tegular Tile

**LINEAR PLAN**

Mark Lighting calculates a continuous run based on optimizing fixture section length and options selected.

**LOP- Linear Optimized Length**

This linear plan supplies the run length based on defined length combinations, resulting in an optimized solution with the fewest segments. LOP

8FT	4FT	3FT
-----	-----	-----

**Total Run Length**

This system is not modular. Runs longer than 8FT will be automatically configured with left, intermediate, and right sections based on nomenclature ordered. Always order the total run length required and not individual sections.

Example: This run to be ordered as one 32FT run.

8FT	8FT	8FT	8FT
-----	-----	-----	-----

Example: This run to be ordered as four 8FT runs. Note: Individual fixtures sections cannot be joined together in the field.

8FT	8FT	8FT	8FT
-----	-----	-----	-----

**MOUNTING**

**FL Trim Run**

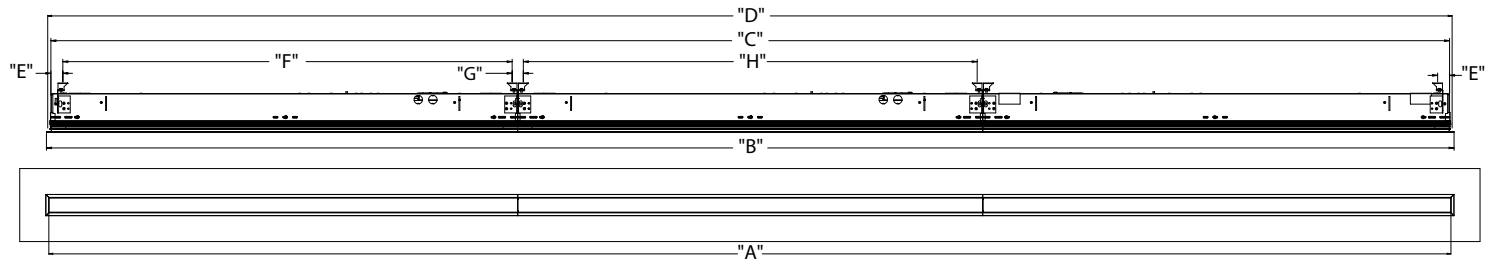

FL Run Configurations							
"A" (Illuminated Lenth)	"B" (Trim Length)	"C" (Housing Lenth)	"D" (Cut Opening Lenth)	"E" (End Mounting Location)	"F" (End Fixture Middle Mounting Point)	"G" (Mounting Point to Mounting Point)	"H" (Mounting Point to Mounting Point Intermediate Fixtures)
Order Length	Order length + 3/16" (W2W, W2N, N2W, N2N) Order length + 11/8" (P2P) Order length + 5/8" (W2P, P2W, N2P, P2N)	Order Length + 3/8"	Order length + 13/16"	13/16"	Fixture length - 1 1/2"	1 1/16"	Fixture length - 1 1/16"

**TG Trim Run**

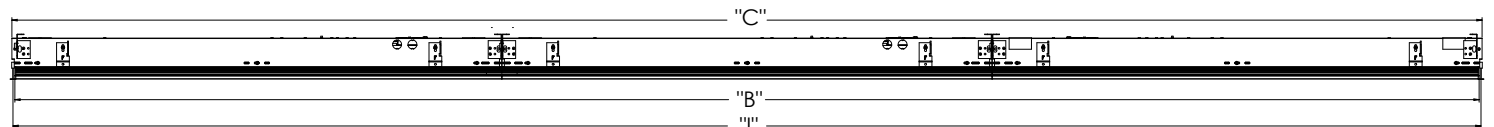

Grid Run Configurations			
"A" (Illuminated Lenth)	"B" (Trim Length)	"C" (Housing Lenth)	"I" (Grid Center to Center)
Order Length - 13/16"	Ordered Length - 5/8"	Order length - 1/32"	Order length + 13/16"

**MOUNTING (continued)**

**Ceiling Cut Out Dimensions**

		2-Foot	3-Foot	4-Foot	5-Foot	6-Foot	7-Foot	8-Foot
TG (BASED ON GRID CENTERLINE TO WALL SPACING)	GRID CL LENGTH(IN)	24	36	48	60	72	84	96
	GRID CL WIDTH(IN)	3.75 - 4.2	3.75 - 4.2	3.75 - 4.2	3.75 - 4.2	3.75 - 4.2	3.75 - 4.2	3.75 - 4.2
FL	LENGTH(IN) - W2W, W2N, N2W, N2N	24.18	36.18	48.18	60.18	72.18	84.18	96.18
	LENGTH(IN) - P2P	24.375	36.375	48.375	60.375	72.375	84.375	96.375
	LENGTH(IN) - W2P, P2W, N2P, P2N	24.25	36.25	48.25	60.25	72.25	84.25	96.25
	WIDTH(IN)	3.93-4.38	3.93-4.38	3.93-4.38	3.93-4.38	3.93-4.38	3.93-4.38	3.93-4.38

CEILING OPENING DIMENSIONS FOR INSTALLATION, +0.13"/-0.00"

**FIXTURE DIMENSIONS AND WEIGHTS**

		2-Foot	3-Foot	4-Foot	5-Foot	6-Foot	7-Foot	8-Foot	
TG	Individual	GRID CL (IN)	24	36	48	60	72	84	96
		OVERALL LENGTH (IN)	23.375	35.375	47.375	59.375	71.375	83.375	95.375
		HOUSING LENGTH (IN)	23.969	35.969	47.969	59.969	71.969	83.969	95.969
		APERTURE (IN)	23.165	35.165	47.165	59.165	71.165	83.165	95.165
	Left or Right	GRID CL (IN)	24	36	48	60	72	84	96
		PRODUCT LENGTH (IN)	23.688	35.688	47.688	59.688	71.688	83.688	95.688
		HOUSING LENGTH (IN)	23.969	35.969	47.969	59.969	71.969	83.969	95.969
		APERTURE (IN)	23.567	35.567	47.567	59.567	71.567	83.567	95.567
	Intermediate	GRID CL (IN)	24	36	48	60	72	84	96
		PRODUCT LENGTH (IN)	24	36	48	60	72	84	96
		HOUSING LENGTH (IN)	23.969	35.969	47.969	59.969	71.969	83.969	95.969
		APERTURE (IN)	24	36	48	60	72	84	96

		2-Foot	3-Foot	4-Foot	5-Foot	6-Foot	7-Foot	8-Foot		
FL	Individual	APERTURE (IN)	24	36	48	60	72	84	96	
		PRODUCT LENGTH (IN) - W2W, W2N, N2W, N2N	24.180	36.180	48.180	60.180	72.180	84.180	96.180	
		PRODUCT LENGTH (IN) - P2P	25.125	37.125	49.125	61.125	73.125	85.125	97.125	
		PRODUCT LENGTH (IN) - W2P, P2W, N2P, P2N	24.652	36.652	48.652	60.652	72.652	84.652	96.652	
		HOUSING LENGTH (IN)	24.375	36.375	48.375	60.375	72.375	84.375	96.375	
		Left	APERTURE (IN)	24	36	48	60	72	84	96
	PRODUCT LENGTH (IN) - W2x, N2x		24.090	36.090	48.090	60.090	72.090	84.090	96.090	
	PRODUCT LENGTH (IN) - P2x		24.562	36.562	48.562	60.562	72.562	84.562	96.562	
	HOUSING LENGTH (IN)		24.188	36.188	48.188	60.188	72.188	84.188	96.188	
	Right		APERTURE (IN)	24	36	48	60	72	84	96
			PRODUCT LENGTH (IN) - x2W, x2N	24.090	36.090	48.090	60.090	72.090	84.090	96.090
		PRODUCT LENGTH (IN) - x2P	24.562	36.562	48.562	60.562	72.562	84.562	96.562	
		HOUSING LENGTH (IN)	24.188	36.188	48.188	60.188	72.188	84.188	96.188	
	Intermediate	APERTURE (IN)	24	36	48	60	72	84	96	
		PRODUCT LENGTH (IN)	24	36	48	60	72	84	96	
		HOUSING LENGTH (IN)	23.969	35.969	47.969	59.969	71.969	83.969	95.969	

\*All values rounded to +/- 1/16"

Approximate Fixture Section Weights		2-Foot	3-Foot	4-Foot	5-Foot	6-Foot	7-Foot	8-Foot
WEIGHT (LBS)		10	13	16	23	25	28	31

**DIRECT SHIELDING & OPTIONS**

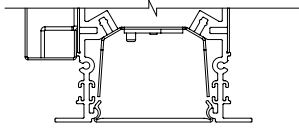

Flush Lens (FLL)  
Continuous Lens (CLL)

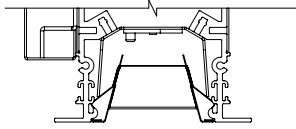

Louver (LVRR)  
Aluminum Louver (LVRR) Painted

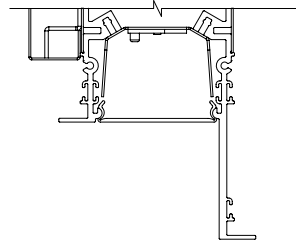

2" Regress with  
FLL or CLL

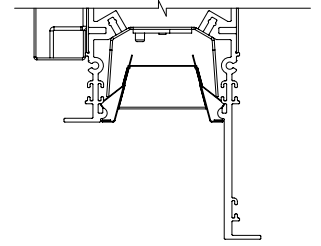

2" Regress with  
LVRR or LVRR

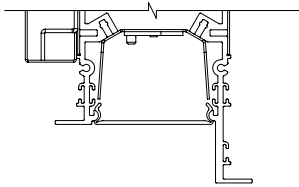

1" Regress with  
FLL or CLL

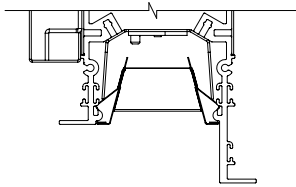

1" Regress with  
LVRR or LVRR

**DIRECT DISTRIBUTION**

Optical Film for DAS and WG distributions with co-extruded lens standard.  
Direction of light for DAS or WG distribution will be in the direction of the notches on the film.

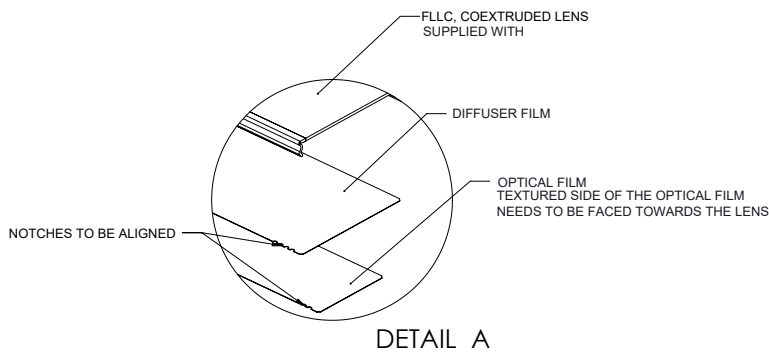
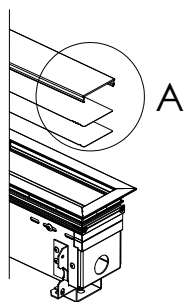

Optical Film	Number of Notches
Diffuser	4
Direct Asymmetric (DAS)	1
Wall Graze (WG)	3

**CONTINUOUS LENS**

40-foot maximum uninterrupted length. From 40-foot 1/8-inch to 106-foot, visible joiner required and supplied with lens rolls. Joiner will match color of trim. Continuous lens and joiners, if required, ship separate from the fixture. Reference installation instructions for further details and steps.

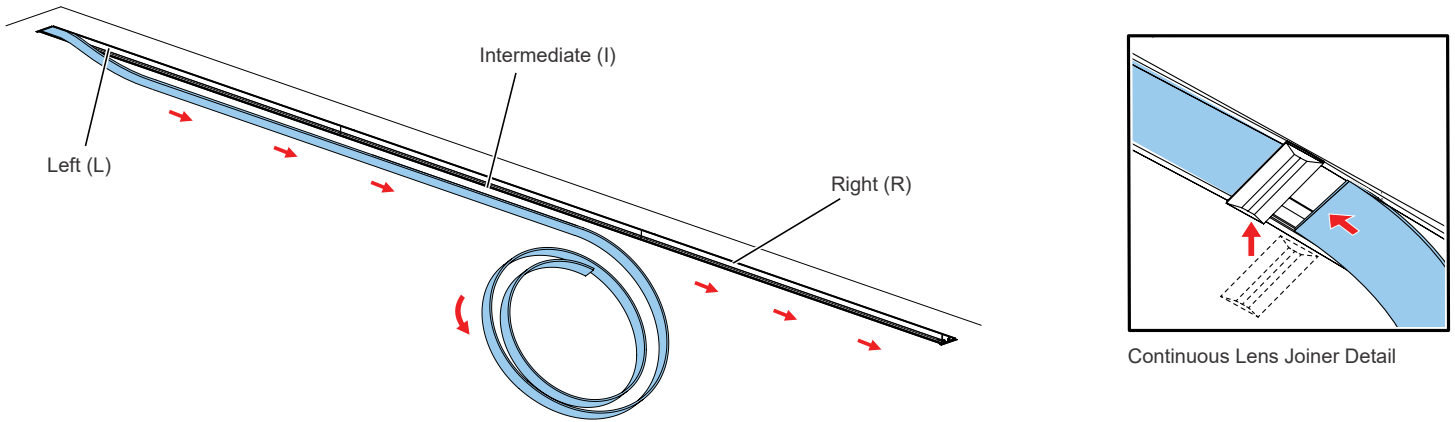

**RUN PATTERNS, CORNERS, & JUNCTIONS**

Patterns can be configured in 1" increments with illuminated L (corner), X, Y, & T connectors. Standard corner has 2' leg segments. Standard L (corner) connector angles are available in 40-179 degrees in 1 degree increments. Standard T & Y connector angles are available in 40-179 degrees in 1 degree increments. Standard X connector angle available in 40-90 degrees in 1 degree increments.

See separate pattern spec sheet for more details.

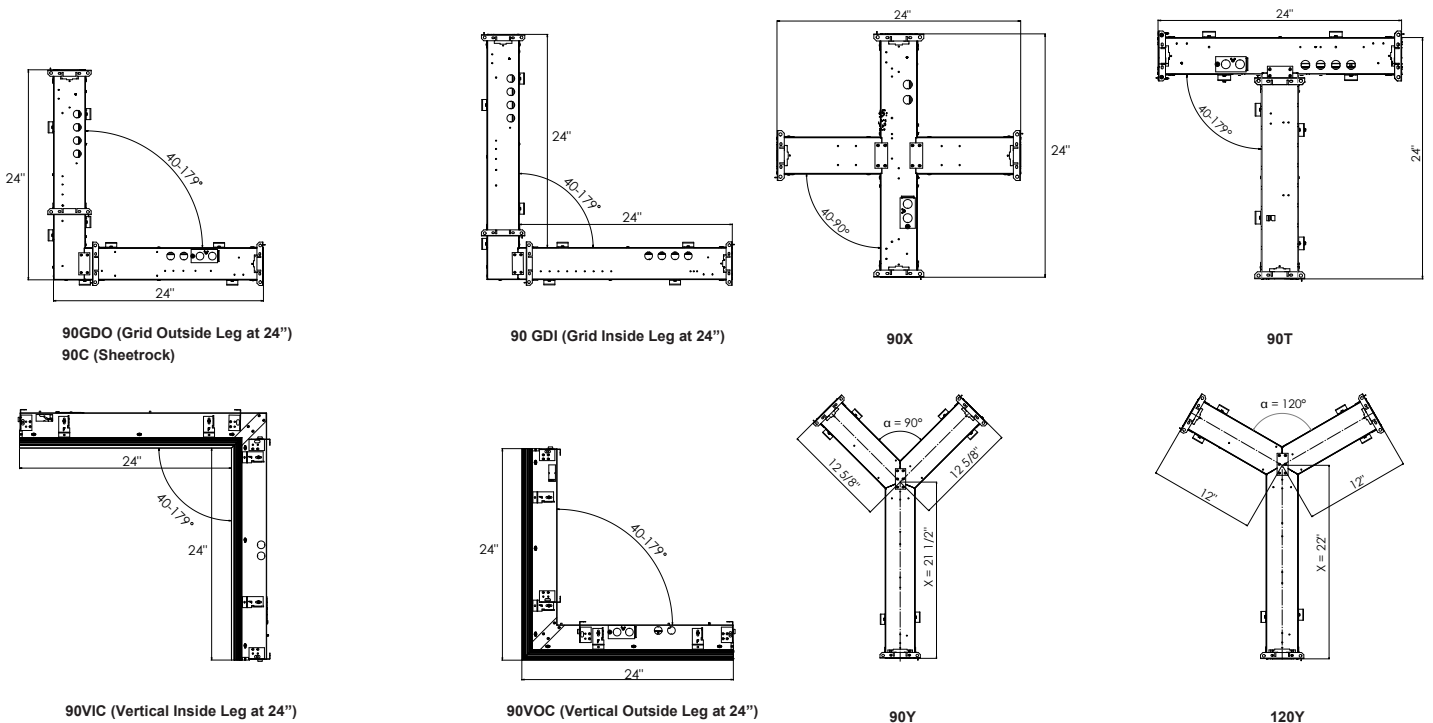

**NOTE:** For Y intersections, dimension X varies depending on the angle  $\alpha$ . Angle  $\alpha$  can be in a range of 40-179°.

**ENDPLATE DETAIL**

**FL Trim Run**

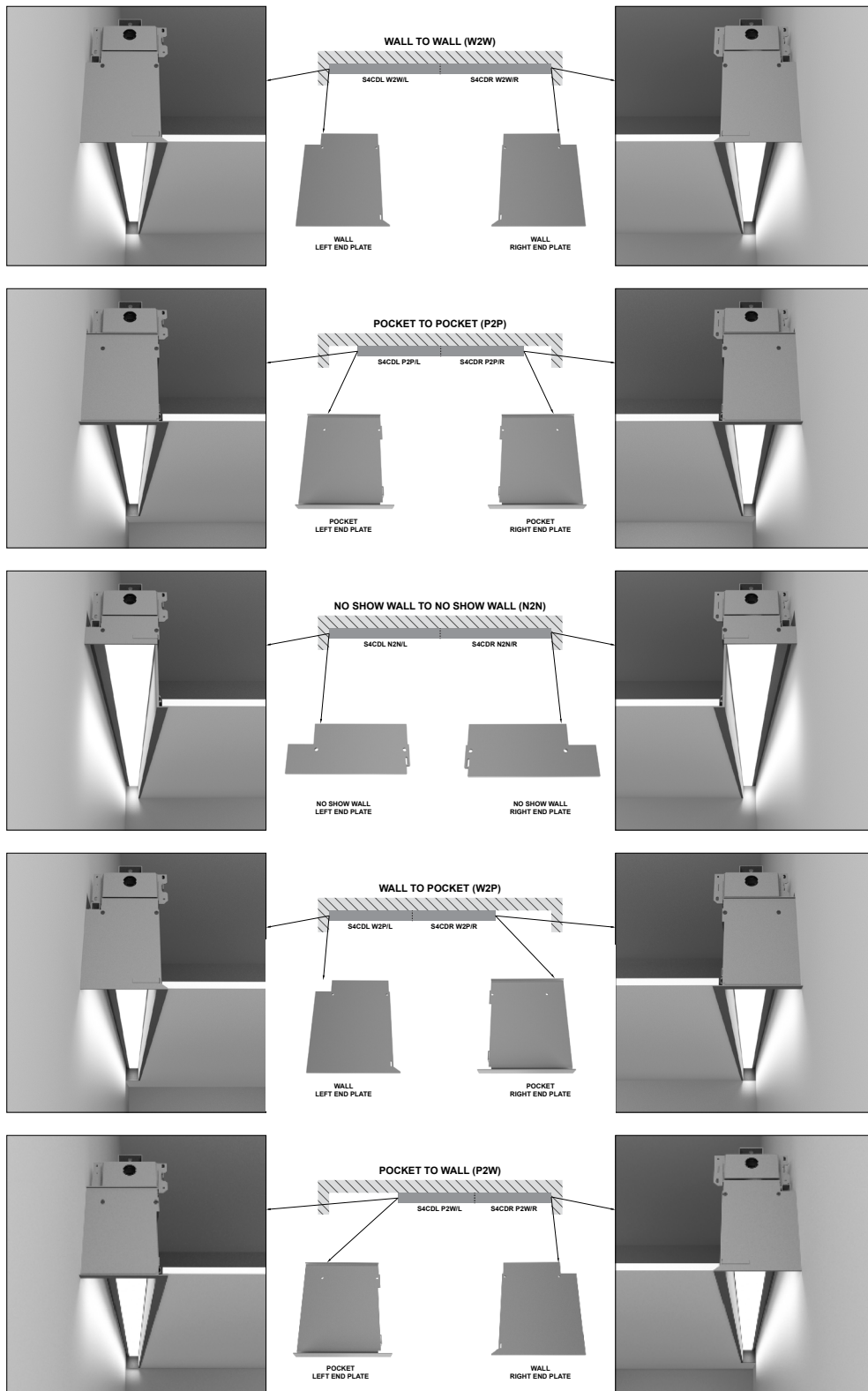

**ENDPLATE DETAIL (continued)**

**FL Trim Run**

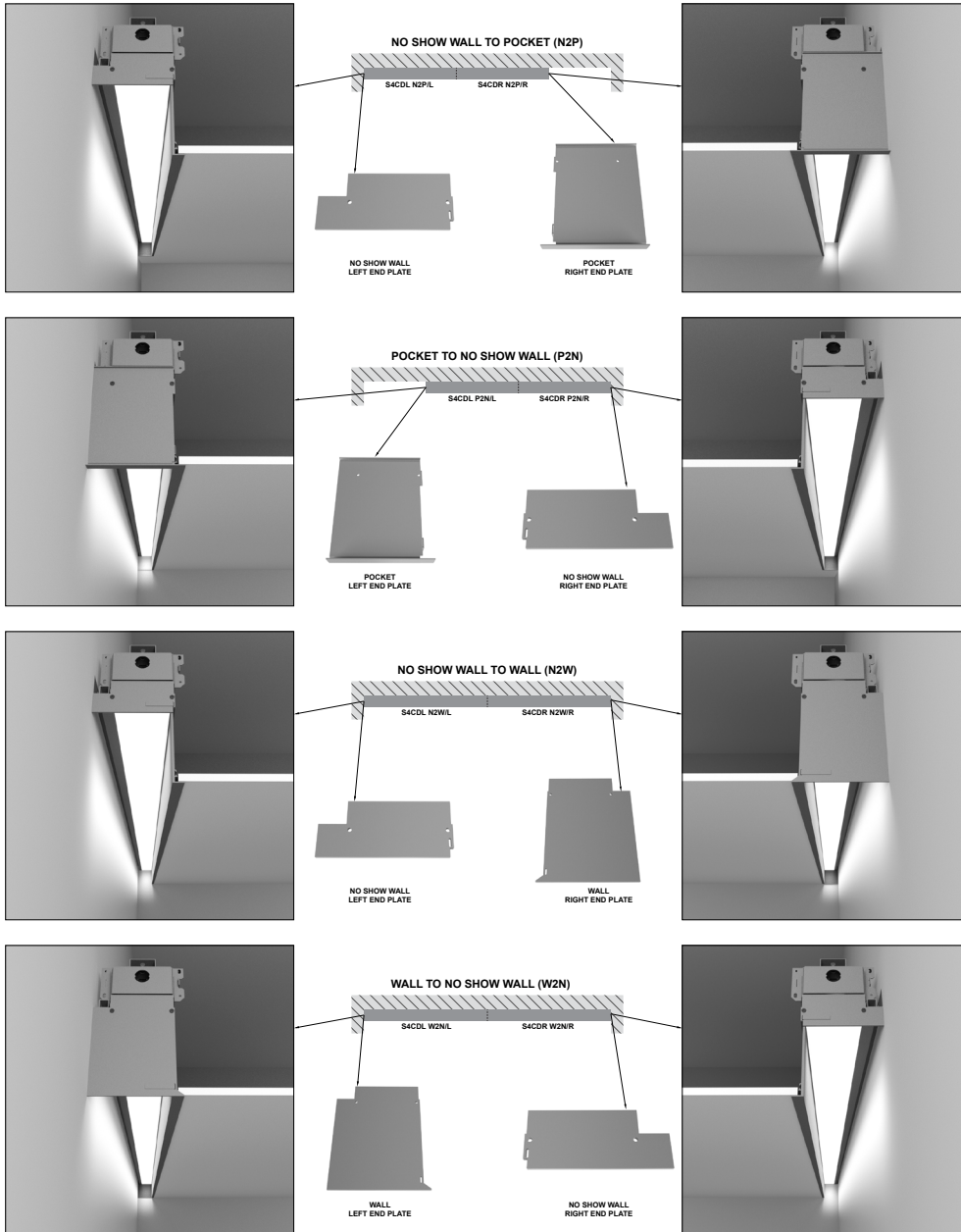

**ENDPLATE DETAIL (continued)**

**TG Trim Run**

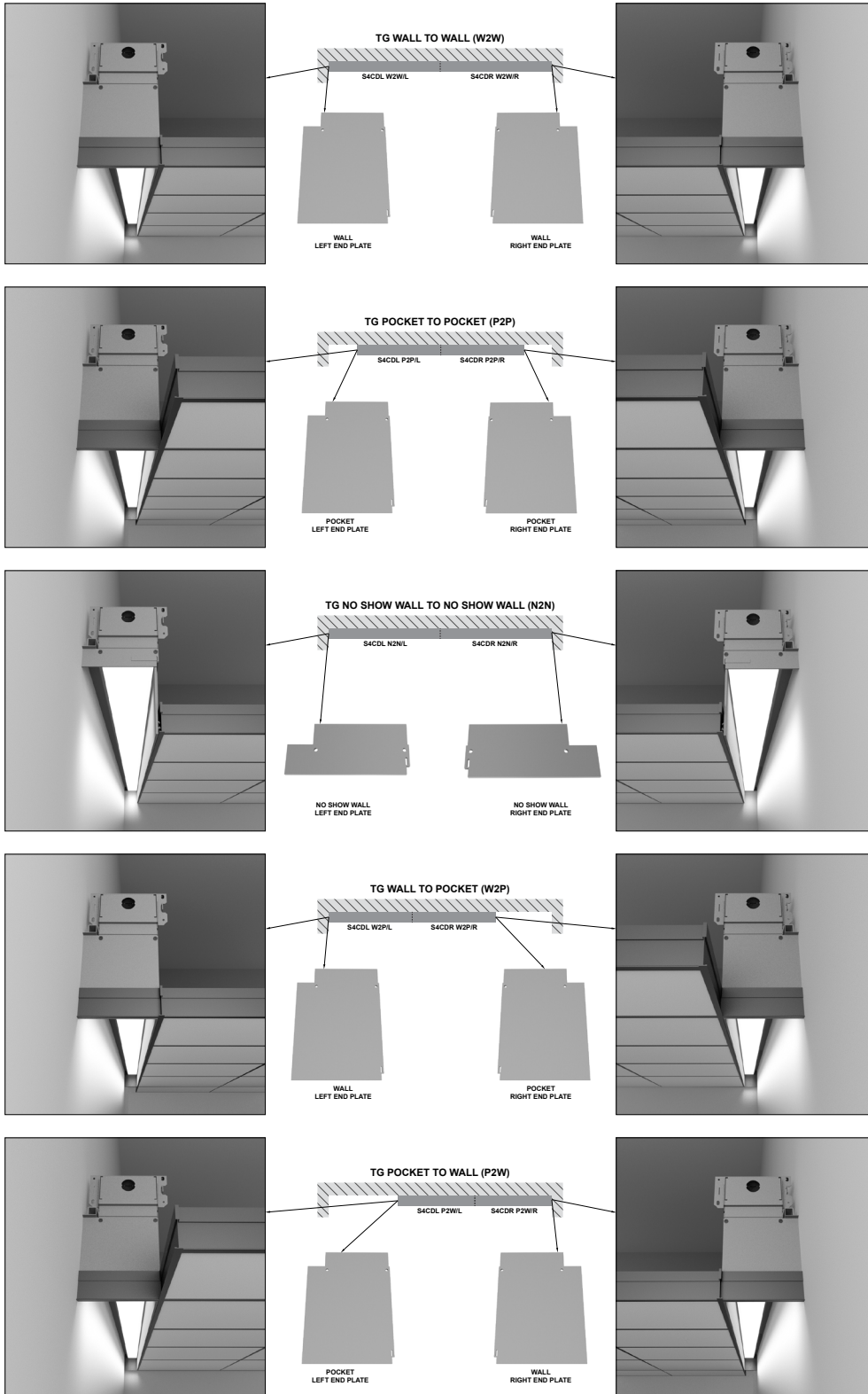

**ENDPLATE DETAIL (continued)**

**TG Trim Run**

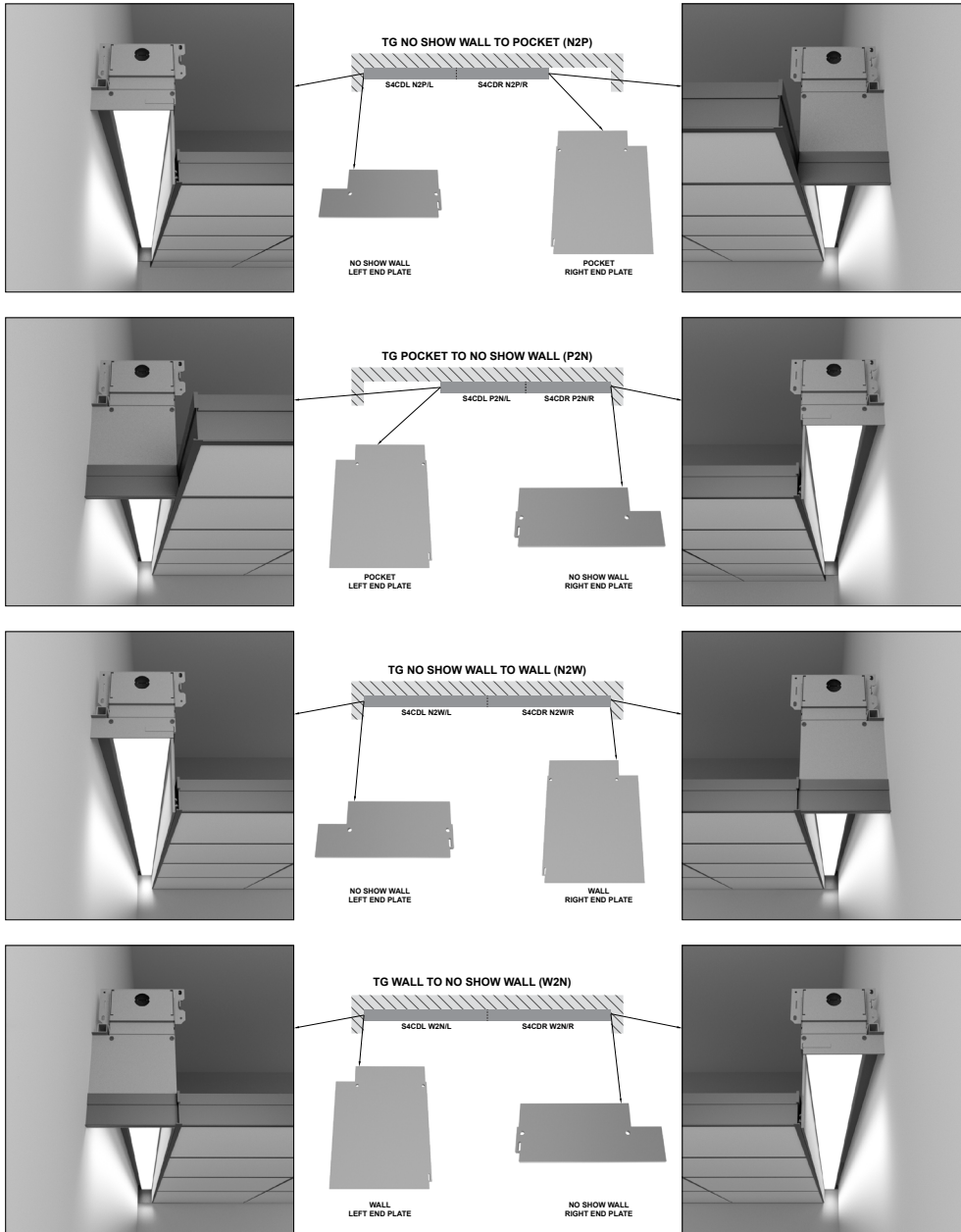

**ADDITIONAL OPTIONS**

**Field Adjustable (+0/-12") Section (ADJS)**

Shipped as a 4, 6, 7, or 8-foot individual or end of run right side fixture. Left end of fixture is field trimmed to length. Reference page 2 ORDERING section for option exclusions.

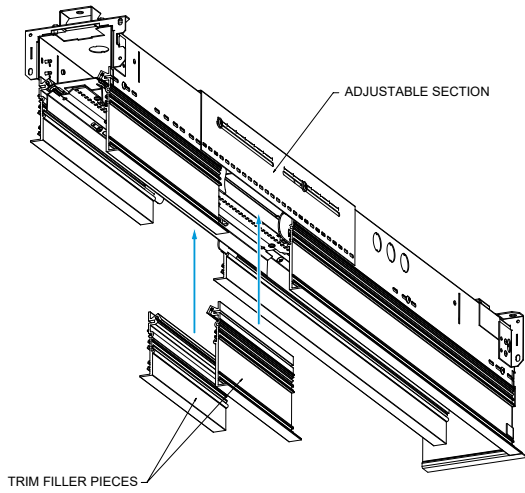

**EMERGENCY OPTIONS**

**Emergency Circuits**

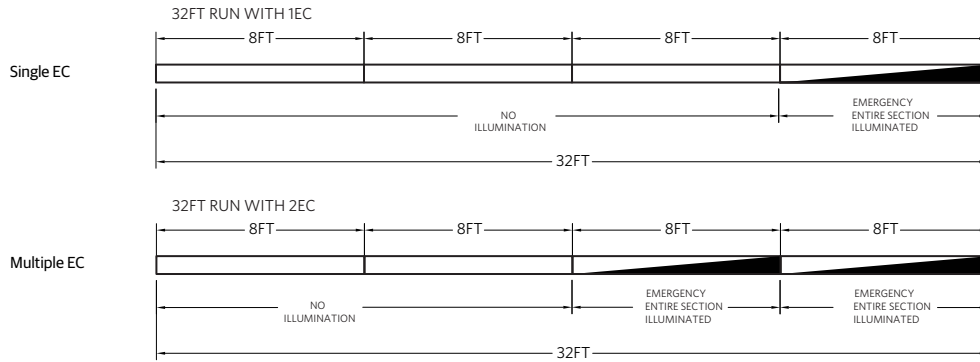

Control Input	
Section Length	EC
U2-U2/11.875	Entire Section Length
U3-U3/11.875	Entire Section Length
U4	Entire Section Length
U4/0.125-U4-11.875	Entire Section Length
U5-U5/11.875	Entire Section Length
U6-U6/11.875	Entire Section Length
U7-U7/11.875	Entire Section Length
U8	Entire Section Length

**INTELLIGENT LUMINAIRE GUIDE**

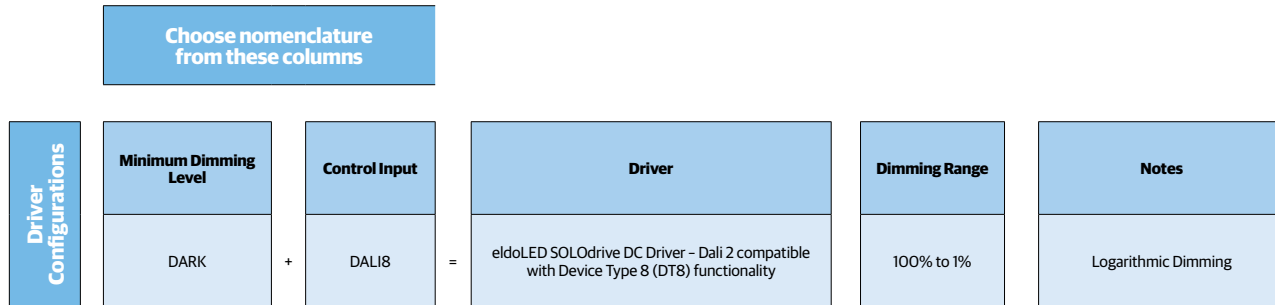

**DC2DC**

**DC-powered Lighting, DC2DC Architecture**

Acuity Brands' DC2DC architecture provides for distributed low-voltage DC power and digital controls for a range of LED luminaires, including the S2CD.

The DC2DC architecture enhances an LED lighting system's efficiency by eliminating the need and cost to convert AC to DC power at the luminaire and facilitating the installation and commissioning of lighting controls. Intrinsically more efficient by design, our DC-powered lighting architecture also delivers savings at design and installation, facilitates maintenance, and empowers lighting design focused on sustainable and well-being applications.

Components include:

- DCHUB (ordered separately), distributes DC power up to 1080 VA of DC-powered LED luminaires including support for emergency lighting.
  - 57 VDC powered LED luminaires, with Static CCT or Tunable White, based on control options.
  - nLight® lighting control
    - Integral or offboard wired networked lighting control, with nLight control devices (ordered separately).
    - Embedded nLight AIR wireless devices in 57VDC powered Static CCT LED luminaires.
  - Class 2 power and control cables.
- The number of luminaires that can be supported by a single DCHUB port is a function of luminaire wattage and conductor losses. Please refer to the fixture wattages listed and the DCHUB spec sheet for additional details. Alternatively, the LED luminaires can be supplied with an approved, UL Listed, Class 2 power source supplying between 52.3 and 57.0 VDC at the input to the luminaire.

**Note:**

All luminaires require 57VDC option along with the corresponding Control Input option for DALI or DALI8 external nPS80 DALI 57VDC wired nLight control or NLTAIR2 or NLTAIREM2 embedded wireless lighting control.

When using external wired nLight control, nPS80 DALI 57 VDC is mounted locally with the controlled luminaires. Only 2 #16 AWG (min.) conductors are necessary between the DC power source and the nPS80 DALI controller, and 4 conductors between the controller and the luminaires.

When using nLight embedded wireless controls only 2 #16 AWG (min.) conductors are necessary between the DC power source and the luminaire runs.

Click [DC2DC](#) for more information.

**FIXTURE PERFORMANCE, DEVICE ADDRESSES, & FEED CHART<sup>1</sup>**

Nominal Lumens/Foot		Slot 2 Recessed Direct <sup>1</sup>									
		300LMF		400LMF		600LMF		800LMF		1000LMF	
CCT		27K	65K	27K	65K	27K	65K	27K	65K	27K	65K
<b>Delivered Lumens/Foot</b>		280	287	380	383	580	576	780	769	979	962
<b>DC Input Watts/Foot<sup>2</sup></b>		2.4	2.3	3.2	3.2	5.0	4.8	6.8	6.5	8.6	8.1
<b>Lumens/Watt</b>		119	123	117	121	116	120	115	119	114	118
<b># Device Addresses and Feeds</b>	<b>2FT</b>	1		1		1		1		1	
	<b>3FT</b>	1		1		1		1		1	
	<b>4FT</b>	1		1		1		1		1	
	<b>5FT<sup>3</sup></b>	2		2		2		2		2	
	<b>6FT<sup>4</sup></b>	2		2		2		2		2	
	<b>7FT<sup>5</sup></b>	2		2		2		2		2	
	<b>8FT<sup>4</sup></b>	2		2		2		2		2	

**Notes**

1. Based on a 4FT 90CRI TUWH RHHR (27K-65K) fixture with 2" depth lens regress (2D), standard lambertian distribution, and flush lens (FLL). Consult factory for other section lengths.
2. Standard photometry based on AC wattage, DC wattage = AC wattage \* .93
3. For 5ft fixtures with two feeds, wattage for Feed 1 is 3/5 of the total wattage and for Feed 2 is 2/5 of the total wattage
4. For 6ft and 8ft fixtures with two feeds, wattage per feed is half of the total wattage
5. For 7ft fixtures with two feeds, wattage for Feed 1 is 4/7 of the total wattage and for Feed 2 is 3/7 of the total wattage

**General Note:** Combine feeds based on maximum port supply wattage or as shown on drawings. Refer to Mark Linear Submittal drawings for additional feed configuration information.

**Example Calculation:**

5FT 1000LMF

Device Addresses and Feeds: 2 Addresses and Feeds

Total Direct Wattage: 8.6 W/FT x 5FT = 43W  
 Direct Feed 1: 3/5 x 43W = 25.8W  
 Direct Feed 2: 2/5 x 43W = 17.2W

## SPECIFICATIONS

### Housing

Nominal 2" x 2', 3', 4', 5', 6', 7', 8' and continuous rows in 1/8" increments starting at 2', as standard. Upper housing fabricated from cold-rolled steel with extruded aluminum ceiling trim.

### Finish

Standard colors for fixture trims are polyester powder coated white, anti-microbial white, black, or silver with satin sheen. Consult factory for custom colors or specify RAL colors from Architectural brochure.

### Reflector

Precision-formed steel; high reflectance matte white powder coat; 93% reflectivity.

### Optics (Distribution)

Wall Graze (WG) and Direct Asymmetric (DAS) incorporate co-extruded lenses and films.

### Lenses/Shielding

Extruded acrylic lens, (CLL, FLL). Aluminum louver with either a powder coat finish to match housing color (LVRR) or aluminum finish (LVRRRA).

### Mounting

Sheetrock: Recessed ceiling only to accommodate sheetrock, 1/2" minimum to 1-1/2" maximum depth for FL trim option.

Grid: To accommodate 9/16" Flat Tee with Lay-In Tile, 9/16" Flat Tee with Tegular Tile, 9/16" Slot Tee with Tegular Tile, 15/16" Flat Tee with Lay-In Tile, & 15/16" Flat Tee with Tegular Tile for TG trim option.

### LED Source

Multiple lumen packages available in Rhythm Range (2700K-6500K) in 90CRI. The Acuity Brands circuit boards for the linear LED components use a precise binning algorithm which creates a consistent color temperature from board to board. Color variation of no greater than a 2.5 Step MacAdam (2.55DECM) along the black body locus from board to board.

### Electrical

Long-life LEDs, coupled with high-efficiency drivers, provide superior quantity and quality of illumination for extended service life. 90% LED lumen maintenance at 60,000 hours (L90/60,000).

### Circuits

Single switching option only.

### Dimming Driver

eldoLED constant current driver options deliver choice of dimming range for ultrasmooth dimming resolution from 100% to less than 1% , and choices for control, while assuring flicker free, low current inrush, 89% efficiency and low EMI. Luminaires operate over a voltage ranging from 53VDC to 57VDC.

### Ambient Operating Temperature Range

-20°C (-4° F) to +25°C (+77°F)

### Environment

Suitable for damp location. Indoor use only.

### Certification

CSA certified to meet U.S. and Canadian standards (UL1598 and UL8750). This product is IC rated.

### Fixture Weight

Approximately 4.0 lbs per foot, less packaging.

### Warranty

5-year limited warranty. This is the only warranty provided and no other statements in this specification sheet create any warranty of any kind. All other express and implied warranties are disclaimed. Complete warranty terms located at: [www.acuitybrands.com/support/warranty/terms-and-conditions](http://www.acuitybrands.com/support/warranty/terms-and-conditions)

**Notes:** Actual performance may differ as a result of end-user environment and application.

All values are design or typical values, measured under laboratory conditions at 25°C.

Specifications subject to change without notice