

SLOT 2

PERIMETER

HIGHLIGHTS

- Compact profile
- Uniform illumination along wall surface
- Extruded aluminum and sheet metal construction
- Regressed snap-in acrylic lens
- Field adjustable telescopic end, up to 12 inches
- Integrated control with optional nLight® or nLight Air® for system networking
- Driver options for Dim to Dark, 1% or 10% minimum dimming
- White, black or silver paint with satin finish
- UGR data available on page 4

DIMENSIONS

FL Trim with 2D Lens Regress

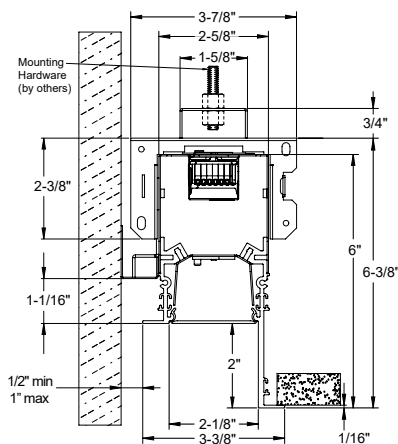

FIXTURE PERFORMANCE

Nominal Lumens/Foot	Direct						
	300LMF	400LMF	600LMF	800LMF	1000LMF	1200LMF	1300LMF
Delivered Lumens/Foot	266	355	531	698	860	1036	1114
Input Watts/Foot	2.58	3.40	5.04	6.78	8.50	10.50	11.65
Lumens/Watt	103	105	105	103	101	99	96

Based on a 4FT 90CRI 35K fixture with 2" depth lens regress (2D), standard lambertian distribution, and flush lens (FLL)



DIRECT DISTRIBUTION

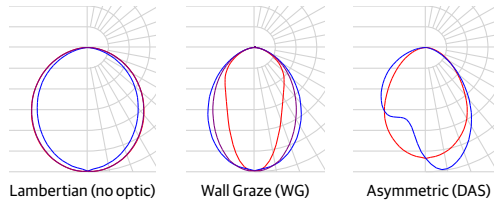

DIFFUSERS/SHIELDING

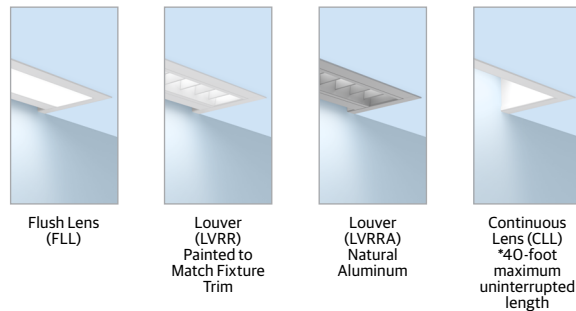

ORDERING

Example: S2CD LOP 32FT 2D ADJS FL 90CRI 35K 800LMF SCT MINI FLL MVOLT BLKT ZT W2W CP

Series	Linear Plan	Total Run Length	Lens Regress Depth	Mounting	Ceiling Type
S2CD Slot 2 Perimeter Direct	LOP Optimized Length	_FT_ Specify continuous linear feet to nearest 1/8" increments starting at 2FT (Example 24' - 6 1/8" = 24FT6.125) _FT' Specify continuous linear feet to nearest 1/8" increments starting at 2FT (Example 24' - 6 1/8" = 24FT6.125) Unit length may affect available options. For runs longer than 8FT: ALWAYS order the run by the TOTAL RUN LENGTH. Ordering the sections individually will not provide the correct joining hardware to allow run connections in the field. 1. Use whole foot increment when using ADJS, LVRR, LVRRRA, or zoning options.	OD 0" Depth 1D' 1" Depth 2D' 2" Depth 1. Not available with Direct Distribution options.	<blank> Fixed Length ADJS ^{1,2} Field Adjustable (+0/-12") Section at End of Run 1. Supplied as a 4, 6, 7, or 8-foot individual or section at end of run. Left end is field trimmed to length. 2. Not available with DAS, WG, NLTAIR2, EIOWLCP, GTD, PWS, or CP options in entire run.	FL 5/8IN Flange (sheetrock) TG Grid Ceiling: 9/16" Flat Tee with Lay-In Tile, 9/16" Flat Tee with Tegular Tile, 9/16" Slot Tee with Tegular Tile, 15/16" Flat Tee with Lay-In Tile, & 15/16" Flat Tee with Tegular Tile

Direct Light Source Color Rendering	Direct LED Color Temperature	Direct LED Light Output	Direct Distribution ^{1,2}	Switching	Minimum Dimming Level
90CRI 90CRI	27K 2700K 30K 3000K 35K 3500K 40K 4000K 50K 5000K	300LMF 300 Lumens per Foot 400LMF 400 Lumens per Foot 600LMF 600 Lumens per Foot 800LMF 800 Lumens per Foot 1000LMF 1,000 Lumens per Foot 1200LMF 1,200 Lumens per Foot 1300LMF 1,300 Lumens per Foot _LMF Specify Lumens between 300LMF and 1300LMF in 50LMF increments	<blank> Lambertian DAS Direct asymmetric distribution WG Wall Graze Distribution 1. Direct Distribution options are only available with FLL Direct Shielding and OD Lens Regress Depth option. 2. Not available with ADJS	SCT Single Circuit	DARK Constant Current, Dimming to 0.1% MINI ² Constant Current, Dimming to 1% MINIO ² Constant Current, Dimming to 10% NODIM ^{1,2} Non Dimming 1. Not available with Control Input. 2. Not available with DALI.

Optional Shielding	Voltage	Finish	Emergency Options	Control Input
CLL ^{3,5} Continuous Flush Lens FLL ⁴ Flush Lens LVRR ^{1,2} Louver (painted same finish color as housing) LVRRRA ^{1,2} Natural Aluminum Louver 1. Not available with TG trim, NLTAIR2, or emergency options EIOWLCP or GTD. 2. Only available in whole foot increments. 3. CLL is not available with DAS or WG distributions. 4. When using distribution options, FLL will change to FLLC to designate a co-extruded lens with white and clear material. 5. 40-foot maximum uninterrupted length.	MVOLT 120-277V 120 ³ 120V 277 ³ 277V 347 ^{1,2} 347V 1. Available with NODIM, MINI, or MINIO dimming and ZT. 2. Not available with EIOWLCP or GTD. 3. Required with GTD.	WHTT White (Satin) AMF Antimicrobial White BLKT Black (Satin) SLVT Silver (Satin) RALTB ¹ RAL Paint Finish 1. RALTB is for pricing only. Replace with applicable RAL number & sheen when placing order	<blank> No Emergency Option _EIOWLCP ^{1,4} Total number of 10W Battery Packs, Constant Power, Self Diagnostic, T20 Compliant _REIOWLCP Total Number of Remote 10W Battery Packs, Constant Power, Self Diagnostics, T20 Compliant Total Number of Emergency Circuits _EC Generic Transfer Device GTD ³ EC Circuit for Entire Run WEC ² 1. EIOWLCP is not available in units 2' to 3'-11-7/8", 4'-0-1/8" to 4'-11-7/8", or with 1D, 2D, ADJS, LVRR, or LVRRRA options. 2. WEC is not available with NLIGHT or NLTAIR2. 3. GTD is remote mounted. GTD is not available with ADJS, 347, or CP options and requires 120 or 277 voltage specified. 4. Available with maximum 1100LMF for complete linear run.	<blank> Non-Dimming ZT 0-10V DALI ¹ DALI NLIGHT nLight Wired NLTAIR2 ² nLight AIR 2 Wireless Enabled 1. Only available with DARK. 2. NLTAIR2 can be used as a normal power sensing device for nLight Air devices and luminaires with EM emergency options. It is not available with NODIM or ADJS.

END Option	Primary Zone	Secondary Zone	Tertiary Zone Indicator	Options
W2W Wall to Wall (Both Ends Terminate at Wall) P2P Pocket to Pocket (Both Ends Terminate at Ceiling) N2N No Show Wall to No Show Wall (Both Ends Terminate at Wall) W2P Wall to Pocket (Start Terminates at Wall & End Terminates at Ceiling) P2W Pocket to Wall (Start Terminates at Ceiling & End Terminates at Wall) N2P No Show Wall to Pocket (Start Terminates at Wall & End Terminates at Ceiling) P2N Pocket to No Show Wall (Start Terminates at Ceiling & End Terminates at Wall) N2W No Show Wall to Wall (Both Ends Terminate at Wall) W2N Wall to No Show Wall (Both Ends Terminate at Wall)	<blank> No Primary Zone NS_ Primary Zone (Specify zone length in feet.) 1. Available in whole foot run length.	<blank> No Secondary Zone SNS_ Secondary Zone (Specify zone length in feet.) 1. Available in whole foot run length.	<blank> No Tertiary Zone TNS_ Tertiary Zone (Specify zone length in feet.) 1. Available in whole foot run length.	<blank> No Options PWS ² 6' Pre-Wire, 18 Gauge, 3/8" Diameter CP ^{1,2} Chicago Plenum BAA Buy America (n) Act and/or Build America Buy America Qualified 1. Not available with NLTAIR2 or GTD. 2. Not available in a run with ADJS option.

PHOTOMETRICS

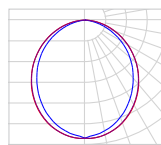

Test Report: ISF25 000625AP3947
IES LM79-08
Catalog #: S2CD 4FT OD 90CRI 35K
1000LMF STD FLL
Lumens: 3653
Wattage: 34.00
Efficacy: 107.45

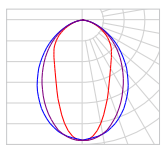

Test Report: ISF25 000844P1090
IES LM79-08
Catalog #: S2CD 4FT OD 90CRI 35K
1000LMF WG FLLC
Lumens: 2907
Wattage: 34.00
Efficacy: 85.50

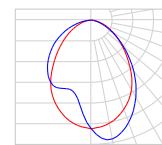

Test Report: ISF25 000846AP1092
IES LM79-08
Catalog #: S2CD 4FT OD 90CRI 35K
1000LMF DAS FLLC
Lumens: 3538
Wattage: 34.00
Efficacy: 104.08

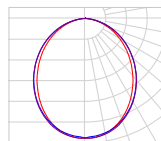

Test Report: ISF25 000843P1851
IES LM79-08
Catalog #: S2CD 4FT OD 90CRI 35K
1000LMF STD CLL
Lumens: 3627
Wattage: 34.00
Efficacy: 106.68

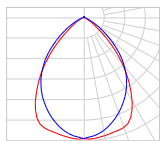

Test Report: ISF25 000849P1096
IES LM79-08
Catalog #: S2CD 4FT OD 90CRI 35K
1000LMF STD LVRRRA
Lumens: 1367
Wattage: 34.00
Efficacy: 40.21

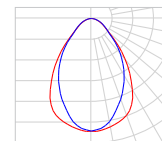

Test Report: ISF25 000848P1096
IES LM79-08
Catalog #: S2CD 4FT OD 90CRI 35K
1000LMF STD LVRR
Lumens: 1602
Wattage: 34.00
Efficacy: 47.12

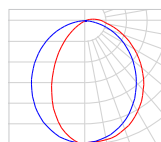

Test Report: ISF25 026095P582
IES LM79-08
Catalog #: S2CD 4FT 1D 90CRI 35K
1000LMF STD FLL
Lumens: 3306
Wattage: 34.00
Efficacy: 101.45

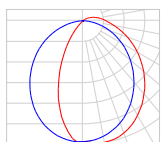

Test Report: ISF25 026098P582
IES LM79-08
Catalog #: S2CD 4FT 2D 90CRI 35K
1000LMF STD FLL
Lumens: 3438
Wattage: 34.00
Efficacy: 101.12

PROJECT LED LUMEN MAINTENANCE

Data references the extrapolated performance projections for the platforms noted in a 25°C ambient, based on 10,000 hours of LED testing (tested per IESNA LM-80-08 and projected per IESNA TM-21-11).

To calculate LLF, use the lumen maintenance factor that corresponds to the desired number of operating hours below. For other lumen maintenance values, contact factory.

Operating Hours	0	10,000	60,000	100,000
Lumen Maintenance Factor	1	0.98	0.84	0.75

CCT SCALING CHART

CCT	CRI	MULTIPLIER	R9
27K	90CRI	0.9444	54.61
30K	90CRI	0.9722	69.01
35K	90CRI	1.0000	83.41
40K	90CRI	1.0278	91.19
50K	90CRI	1.0278	90.86

Lumen scaling charts can be used to approximate the lumen values at different Kelvin temperatures, color rendering indices, optics, or sheilding.

Example: Calculating the lumen change from 90CRI 35K to 90CRI 40K = Lumen output for S2CD 4FT OD 90CRI 35K 1000LMF STD FLL (3653) x 1.0278 multiplier = 3755 lumen

REGRESS DEPTH SCALING CHART

LENS REGRESS DEPTH	MULTIPLIER
OD	1.00
1D	0.90
2D	0.94

*Base fixture with Lambertian distribution, 0" depth lens regress (OD), and flush lens (FLL)

OPTICAL SCALING CHARTS

DISTRIBUTIONS	MULTIPLIER
LAMBERTIAN	1.00
DAS	0.97
WG	0.80
SHIELDING	MULTIPLIER
LVRR	0.44
LVRRA	0.37
CLL	0.99
FLL	1.00

*Base fixture with Lambertian distribution and flush lens (FLL)

50LMF INCREMENT SCALING CHART

NOMINAL LMF	LUMEN	WATTAGE
	MULTIPLIER	MULTIPLIER
300LMF	0.31	0.30
350LMF	0.36	0.35
400LMF	0.41	0.40
450LMF	0.46	0.45
500LMF	0.52	0.50
550LMF	0.57	0.54
600LMF	0.62	0.59
650LMF	0.67	0.64
700LMF	0.72	0.69
750LMF	0.76	0.75
800LMF	0.81	0.80
850LMF	0.86	0.85
900LMF	0.91	0.90
950LMF	0.96	0.95
1000LMF	1.00	1.00
1050LMF	1.06	1.05
1100LMF	1.11	1.10
1150LMF	1.16	1.17
1200LMF	1.21	1.24
1250LMF	1.25	1.30
1300LMF	1.30	1.37

*Base fixture with 0" depth lens regress (OD), standard lambertian distribution, flush lens (FLL), and 1000LMF

UGR CHART

Lumen Package	UGR (70% 50% 20% reflectance using a 4H x 8H room size)													
	Crosswise													
	OD FLL Lambertian	OD CLL Lambertian	OD WG	OD DAS	OD LVRR	OD LVRRRA	1D FLL Lambertian	1D CLL Lambertian	1D LVRR	1D LVRRRA	2D FLL Lambertian	2D CLL Lambertian	2D LVRR	2D LVRRRA
300LMF	21.6	21.9	19.9	19.3	15.1	10.5	21.3	21.3	18.4	17.9	22	22	19.1	18.6
400LMF	22.6	22.9	20.9	20.7	16.1	11.5	22.3	22.3	19.4	18.9	23	23	20.1	19.6
600LMF	24	24.3	22.3	21.7	17.5	12.9	23.7	23.7	20.8	20.3	24.4	24.4	21.5	21
800LMF	25	25.3	23.3	22.4	18.4	13.8	24.6	24.6	21.8	21.2	25.4	25.3	22.5	21.9
1000LMF	25.7	26	24	23	19.2	14.5	25.4	25.3	22.5	22	26.1	26.1	23.2	22.7
1200LMF	26.4	26.6	24.6	23.3	19.8	15.2	26	26	23.2	22.6	26.7	26.7	23.9	23.3
1300LMF	26.6	26.9	24.9	18.3	20.1	15.4	26.3	26.2	23.4	22.9	27	27	24.1	23.6
Lumen Package	Endwise													
	OD FLL Lambertian	OD CLL Lambertian	OD WG	OD DAS	OD LVRR	OD LVRRRA	1D FLL Lambertian	1D CLL Lambertian	1D LVRR	1D LVRRRA	2D FLL Lambertian	2D CLL Lambertian	2D LVRR	2D LVRRRA
	300LMF	22.5	21.2	19.1	21	14.4	5.2	25.1	25.1	22.3	21.7	26.7	26.7	23.8
400LMF	23.5	22.2	20.1	22.4	15.4	6.2	26.1	26.1	23.3	22.7	27.7	27.7	24.8	24.3
600LMF	24.9	23.6	21.5	23.3	16.8	7.6	27.5	27.5	24.7	24.1	29.1	29.1	26.2	25.7
800LMF	25.9	24.5	22.4	24	17.8	8.5	28.5	28.5	25.6	25.1	30.1	30	27.2	26.6
1000LMF	26.6	25.2	23.1	24.7	18.5	9.2	29.2	29.2	26.4	25.8	30.8	30.8	27.9	27.4
1200LMF	27.3	25.9	23.8	24.9	19.2	9.9	29.9	29.8	27	26.4	31.4	31.4	28.6	28
1300LMF	27.5	26.1	24	20	19.4	10.1	30.1	30.1	27.3	26.7	31.7	31.7	28.8	28.3

*UGR varies based on luminaire options and is affected by application dependent parameters. Numbers depicted here are considered "Luminaire-UGR" and/or "Point-UGR" values. To determine a more precise maximum UGR value ("Application-UGR"), a full lighting design layout should be completed with the selected luminaire configuration for each application.

**Click here for more information on: [UGR FAQ](#)

CEILING TRIMS

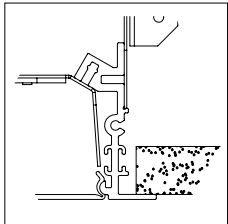

FL
5/8IN Flange (sheetrock)
Install Before Sheetrock

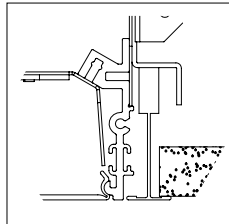

TG
9/16" Flat Tee w/ Lay-in Tile

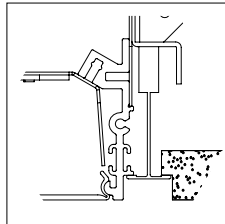

TG
9/16" Flat Tee w/ Tegular Tile

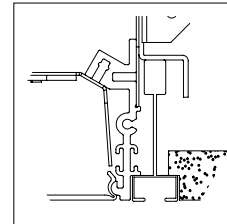

TG
9/16" Slot Tee w/ Tegular Tile

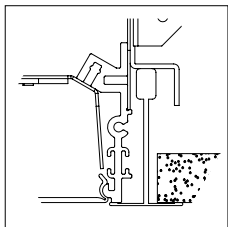

TG
15/16" Flat Tee w/ Lay-in Tile

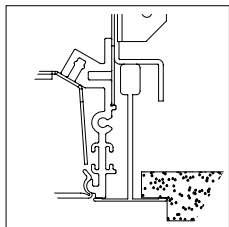

TG
15/16" Flat Tee w/ Tegular Tile

LINEAR PLAN

Mark Lighting calculates a continuous run based on optimizing fixture section length and options selected.

LOP- Linear Optimized Length

This linear plan supplies the run length based on defined length combinations, resulting in an optimized solution with the fewest segments. LOP

8FT	4FT	3FT
-----	-----	-----

Total Run Length

This system is not modular. Runs longer than 8FT will be automatically configured with left, intermediate, and right sections based on nomenclature ordered. Always order the total run length required and not individual sections.

Example: This run to be ordered as one 32FT run.

8FT	8FT	8FT	8FT
-----	-----	-----	-----

Example: This run to be ordered as four 8FT runs. Note: Individual fixtures sections cannot be joined together in the field.

8FT	8FT	8FT	8FT
-----	-----	-----	-----

MOUNTING

FL Trim Run

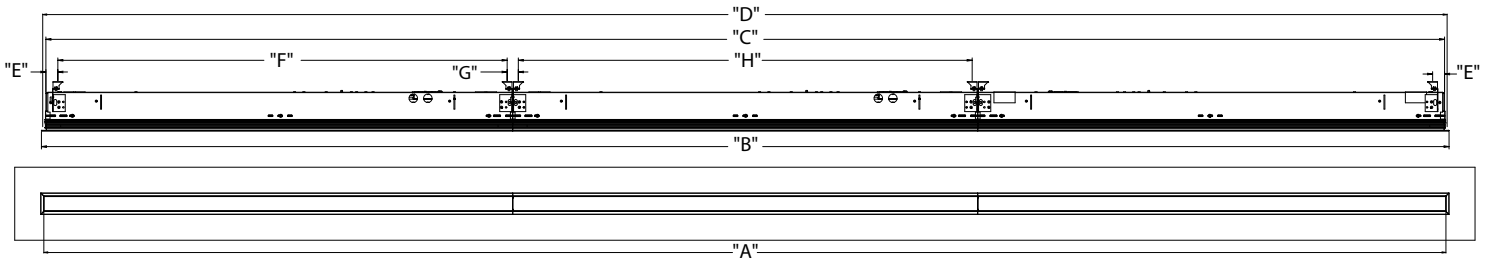

FL Run Configurations							
"A" (Illuminated Lenth)	"B" (Trim Length)	"C" (Housing Lenth)	"D" (Cut Opening Lenth)	"E" (End Mounting Location)	"F" (End Fixture Middle Mounting Point)	"G" (Mounting Point to Mounting Point)	"H" (Mounting Point to Mounting Point Intermediate Fixtures)
Order Length	Order length + 3/16" (W2W, W2N, N2W, N2N) Order length + 1 1/8" (P2P) Order length + 5/8" (W2P, P2W, N2P, P2N)	Order Length + 3/8"	Order length + 13/16"	13/16"	Fixture length - 1 1/2"	1 1/16"	Fixture length - 1 1/16"

TG Trim Run

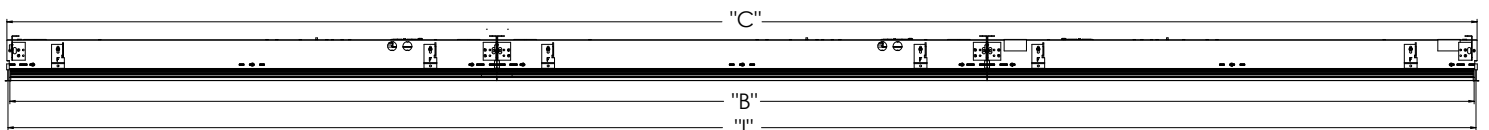

Grid Run Configurations			
"A" (Illuminated Lenth)	"B" (Trim Length)	"C" (Housing Lenth)	"I" (Grid Center to Center)
Order Length - 13/16"	Ordered Length - 5/8"	Order length - 1/32"	Order length + 13/16"

MOUNTING (continued)

Ceiling Cut Out Dimensions

		2-Foot	3-Foot	4-Foot	5-Foot	6-Foot	7-Foot	8-Foot
TG (BASED ON GRID CENTERLINE TO WALL SPACING)	GRID CL LENGTH(IN)	24	36	48	60	72	84	96
	GRID CL WIDTH(IN)	3.75 - 4.2	3.75 - 4.2	3.75 - 4.2	3.75 - 4.2	3.75 - 4.2	3.75 - 4.2	3.75 - 4.2
FL	LENGTH(IN) - W2W, W2N, N2W, N2N	24.18	36.18	48.18	60.18	72.18	84.18	96.18
	LENGTH(IN) - P2P	24.375	36.375	48.375	60.375	72.375	84.375	96.375
	LENGTH(IN) - W2P, P2W, N2P, P2N	24.25	36.25	48.25	60.25	72.25	84.25	96.25
	WIDTH(IN)	3.93-4.38	3.93-4.38	3.93-4.38	3.93-4.38	3.93-4.38	3.93-4.38	3.93-4.38

CEILING OPENING DIMENSIONS FOR INSTALLATION, +0.13"/-0.00"

FIXTURE DIMENSIONS AND WEIGHTS

			2-Foot	3-Foot	4-Foot	5-Foot	6-Foot	7-Foot	8-Foot
TG	Individual	GRID CL (IN)	24	36	48	60	72	84	96
		OVERALL LENGTH (IN)	23.375	35.375	47.375	59.375	71.375	83.375	95.375
		HOUSING LENGTH (IN)	23.969	35.969	47.969	59.969	71.969	83.969	95.969
		APERTURE (IN)	23.165	35.165	47.165	59.165	71.165	83.165	95.165
	Left or Right	GRID CL(IN)	24	36	48	60	72	84	96
		PRODUCT LENGTH(IN)	23.688	35.688	47.688	59.688	71.688	83.688	95.688
		HOUSING LENGTH(IN)	23.969	35.969	47.969	59.969	71.969	83.969	95.969
		APERTURE(IN)	23.567	35.567	47.567	59.567	71.567	83.567	95.567
	Intermediate	GRID CL(IN)	24	36	48	60	72	84	96
		PRODUCT LENGTH(IN)	24	36	48	60	72	84	96
		HOUSING LENGTH(IN)	23.969	35.969	47.969	59.969	71.969	83.969	95.969
		APERTURE(IN)	24	36	48	60	72	84	96

			2-Foot	3-Foot	4-Foot	5-Foot	6-Foot	7-Foot	8-Foot
FL	Individual	APERTURE(IN)	24	36	48	60	72	84	96
		PRODUCT LENGTH(IN) - W2W, W2N, N2W, N2N	24.180	36.180	48.180	60.180	72.180	84.180	96.180
		PRODUCT LENGTH(IN) - P2P	25.125	37.125	49.125	61.125	73.125	85.125	97.125
		PRODUCT LENGTH(IN) - W2P, P2W, N2P, P2N	24.652	36.652	48.652	60.652	72.652	84.652	96.652
		HOUSING LENGTH(IN)	24.375	36.375	48.375	60.375	72.375	84.375	96.375
	Left	APERTURE(IN)	24	36	48	60	72	84	96
		PRODUCT LENGTH(IN) - W2x, N2x	24.090	36.090	48.090	60.090	72.090	84.090	96.090
		PRODUCT LENGTH(IN) - P2x	24.562	36.562	48.562	60.562	72.562	84.562	96.562
		HOUSING LENGTH(IN)	24.188	36.188	48.188	60.188	72.188	84.188	96.188
	Right	APERTURE(IN)	24	36	48	60	72	84	96
		PRODUCT LENGTH(IN) - x2W, x2N	24.090	36.090	48.090	60.090	72.090	84.090	96.090
		PRODUCT LENGTH(IN) - x2P	24.562	36.562	48.562	60.562	72.562	84.562	96.562
		HOUSING LENGTH(IN)	24.188	36.188	48.188	60.188	72.188	84.188	96.188
	Intermediate	APERTURE(IN)	24	36	48	60	72	84	96
		PRODUCT LENGTH(IN)	24	36	48	60	72	84	96
		HOUSING LENGTH(IN)	23.969	35.969	47.969	59.969	71.969	83.969	95.969

*All values rounded to +/- 1/16"

Approximate Fixture Section Weights		2-Foot	3-Foot	4-Foot	5-Foot	6-Foot	7-Foot	8-Foot
WEIGHT(LBS)		10	13	16	23	25	28	31

DIRECT SHIELDING & OPTIONS

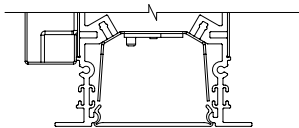

Flush Lens (FLL)
Continuous Lens (CLL)

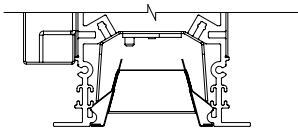

Louver (LVRR)
Aluminum Louver (LVRR) Painted

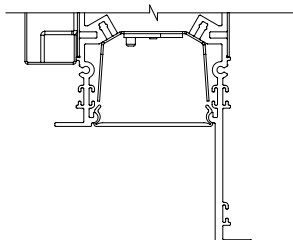

2" Regress with
FLL or CLL

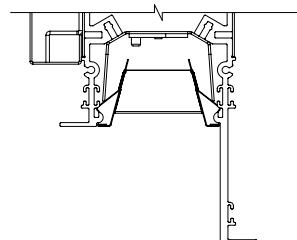

2" Regress with
LVRR or LVRR

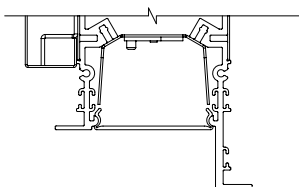

1" Regress with
FLL or CLL

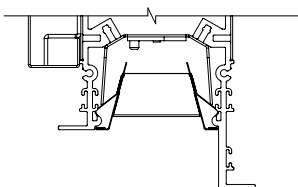

1" Regress with
LVRR or LVRR

DIRECT DISTRIBUTION

Optical Film for DAS and WG distributions with co-extruded lens standard.
Direction of light for DAS or WG distribution will be in the direction of the notches on the film.

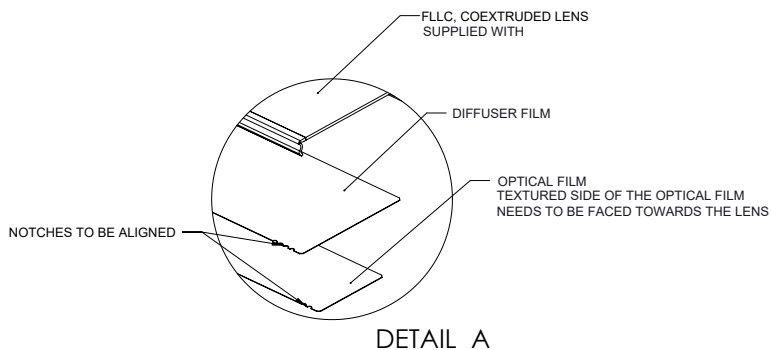
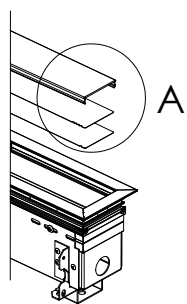

Optical Film	Number of Notches
Diffuser	4
Direct Asymmetric (DAS)	1
Wall Graze (WG)	3

CONTINUOUS LENS

40-foot maximum uninterrupted length. From 40-foot 1/8-inch to 106-foot, visible joiner required and supplied with lens rolls. Joiner will match color of trim. Continuous lens and joiners, if required, ship separate from the fixture. Reference installation instructions for further details and steps.

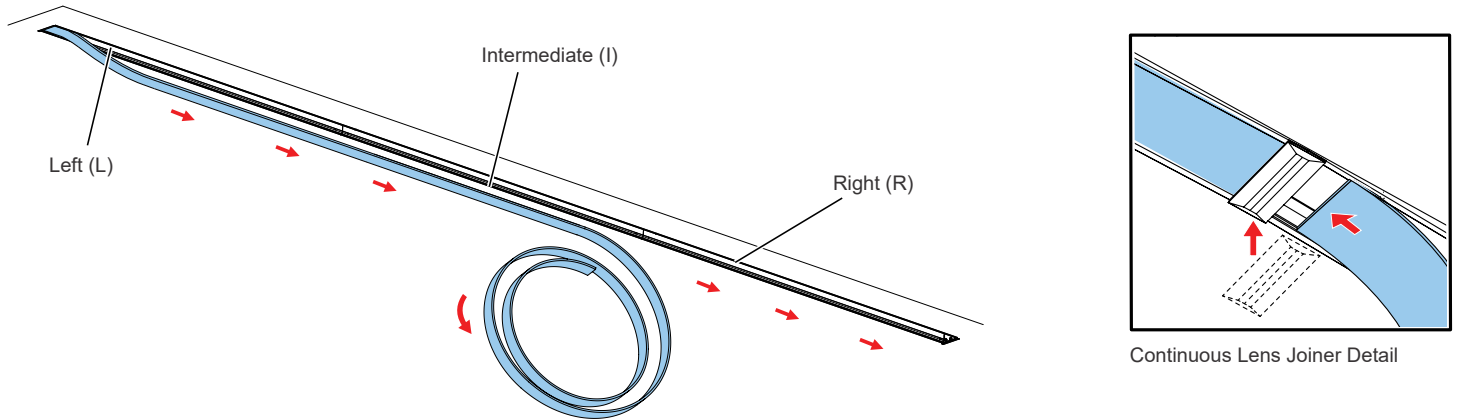

RUN PATTERNS, CORNERS, & JUNCTIONS

Patterns can be configured in 1' increments with illuminated L (corner), X, Y, & T connectors. Standard corner has 2' leg segments. Standard L (corner) connector angles are available in 40-179 degrees in 1 degree increments. Standard T & Y connector angles are available in 40-179 degrees in 1 degree increments. Standard X connector angle available in 40-90 degrees in 1 degree increments.

See separate pattern spec sheet for more details.

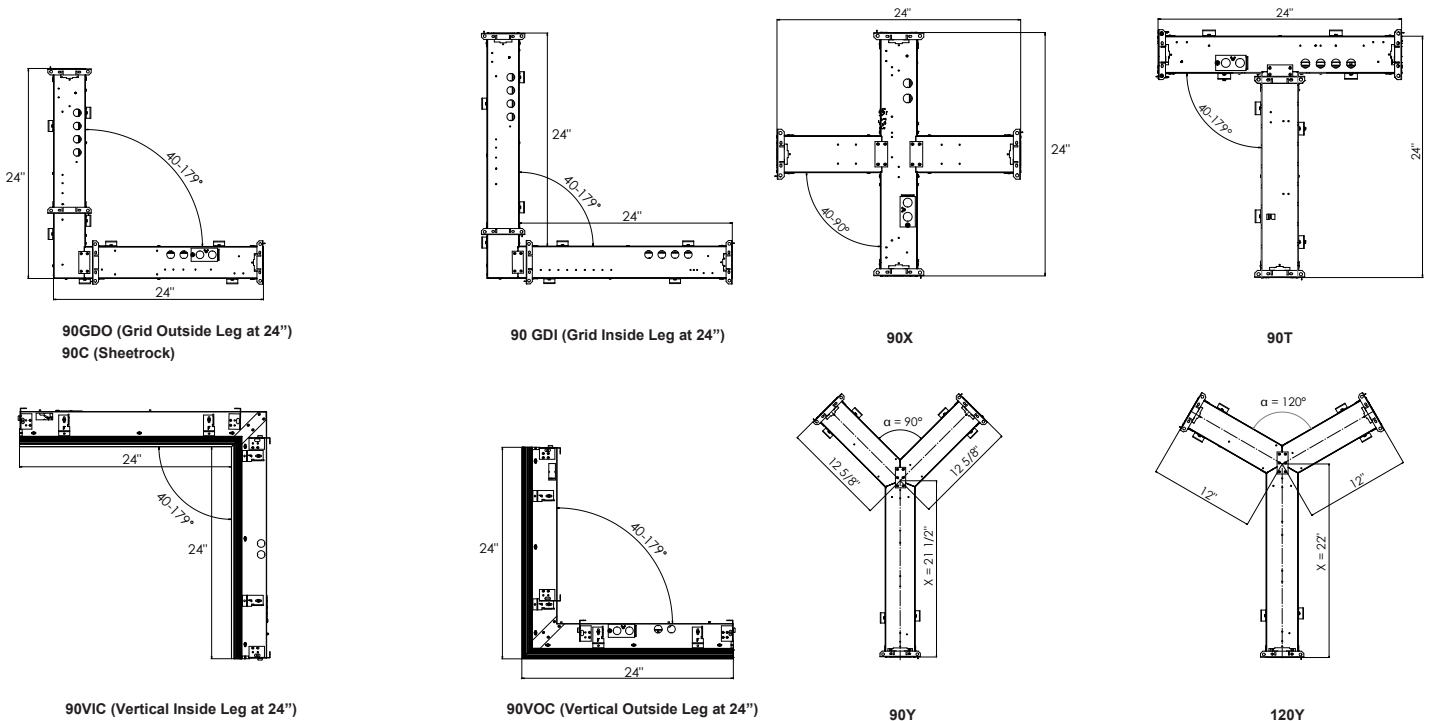

NOTE: For Y intersections, dimension X varies depending on the angle α . Angle α can be in a range of 40-179°.

ENDPLATE DETAIL

FL Trim Run

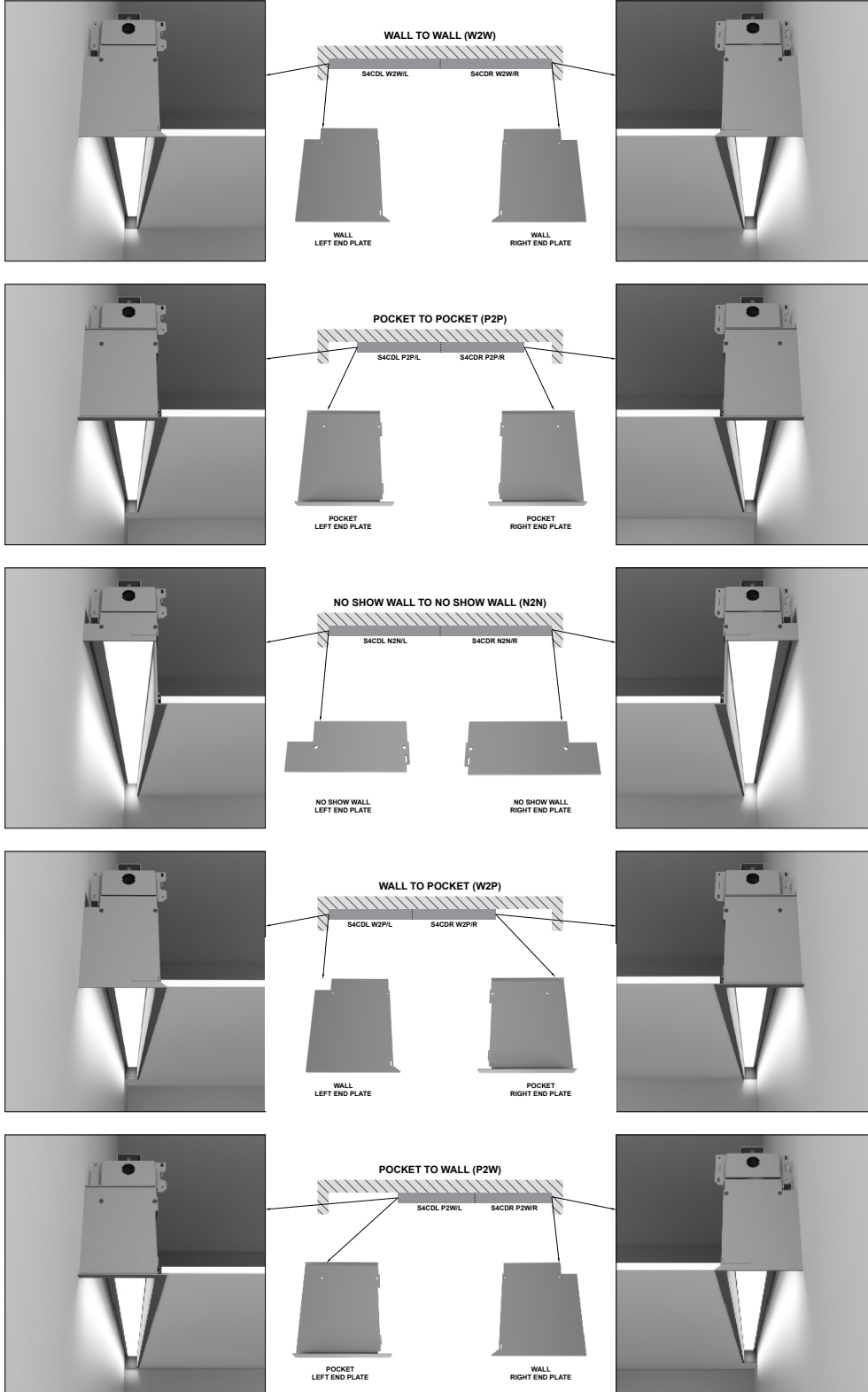

ENDPLATE DETAIL (continued)

FL Trim Run

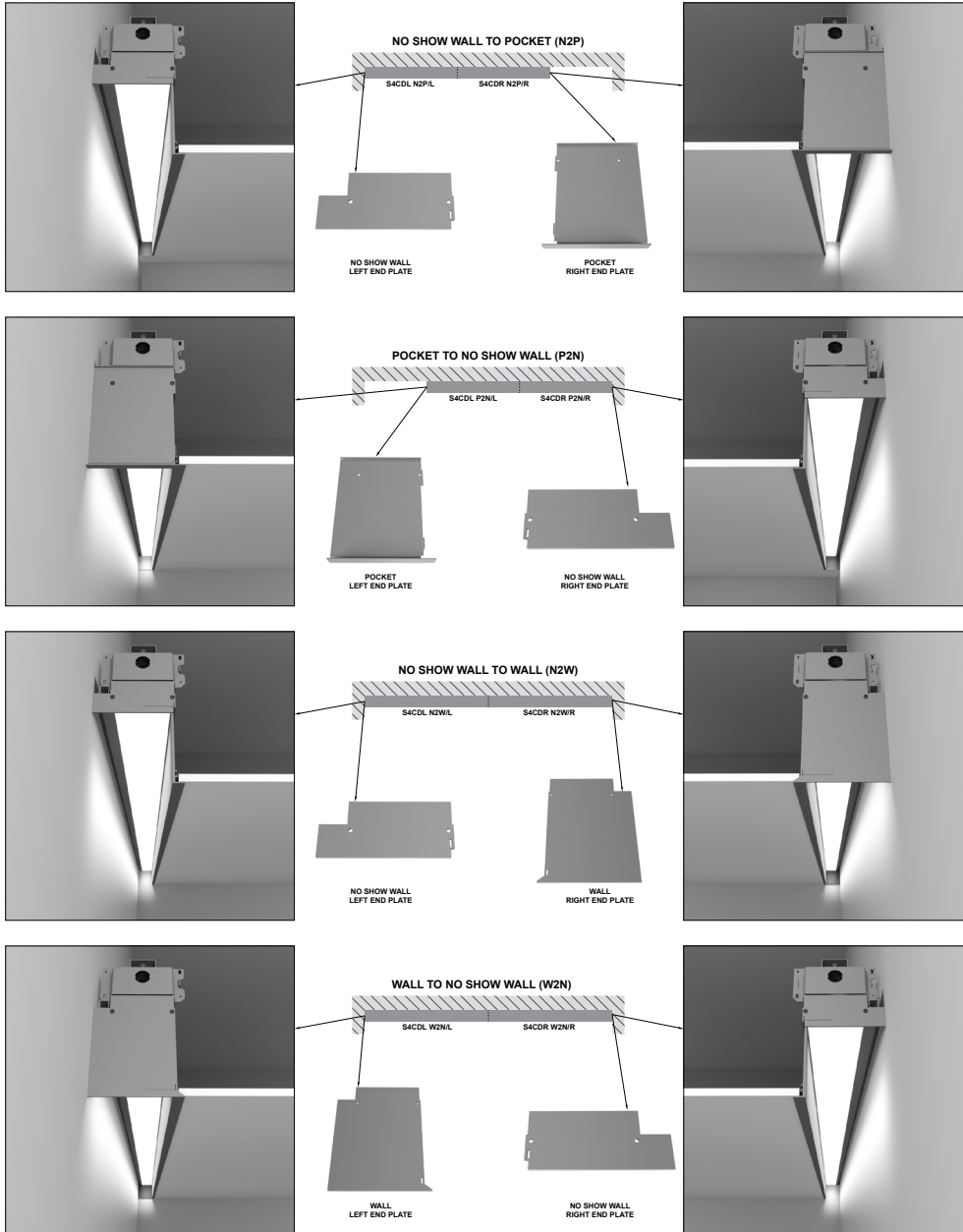

ENDPLATE DETAIL (continued)

TG Trim Run

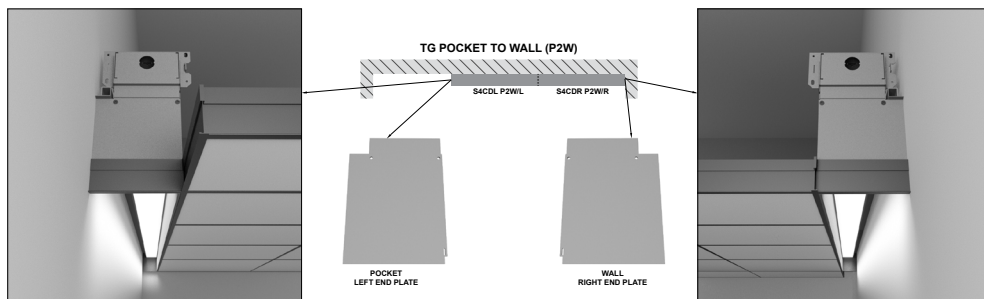
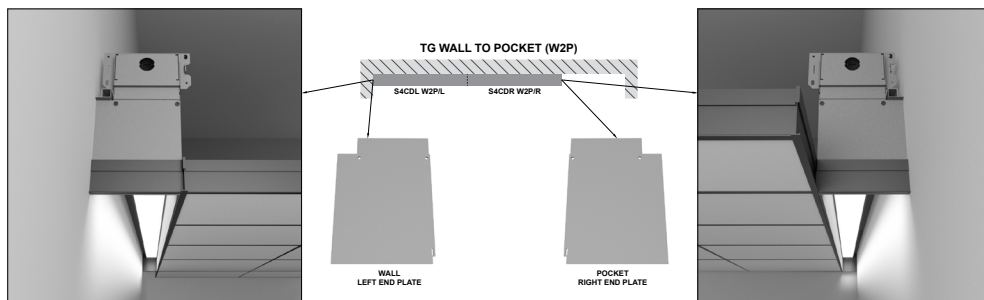
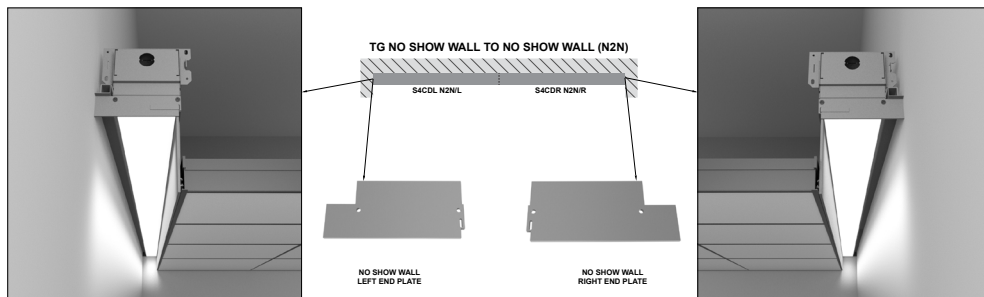
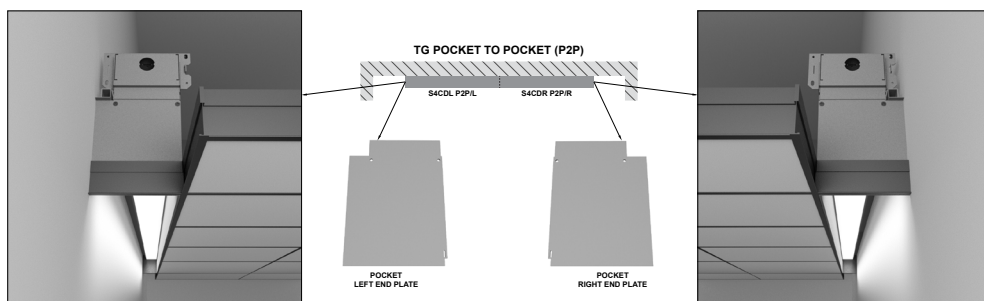
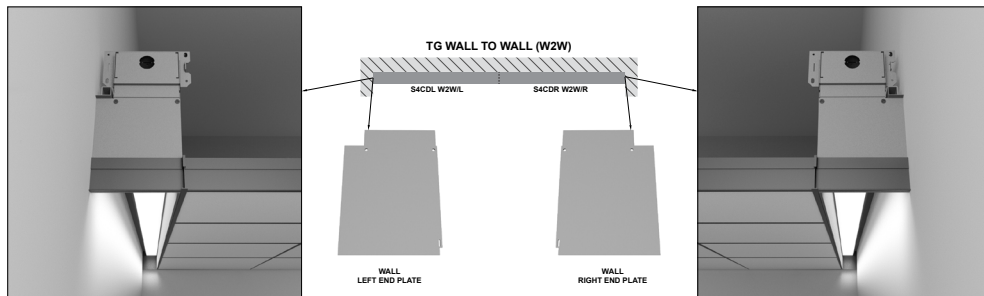

ENDPLATE DETAIL (continued)

TG Trim Run

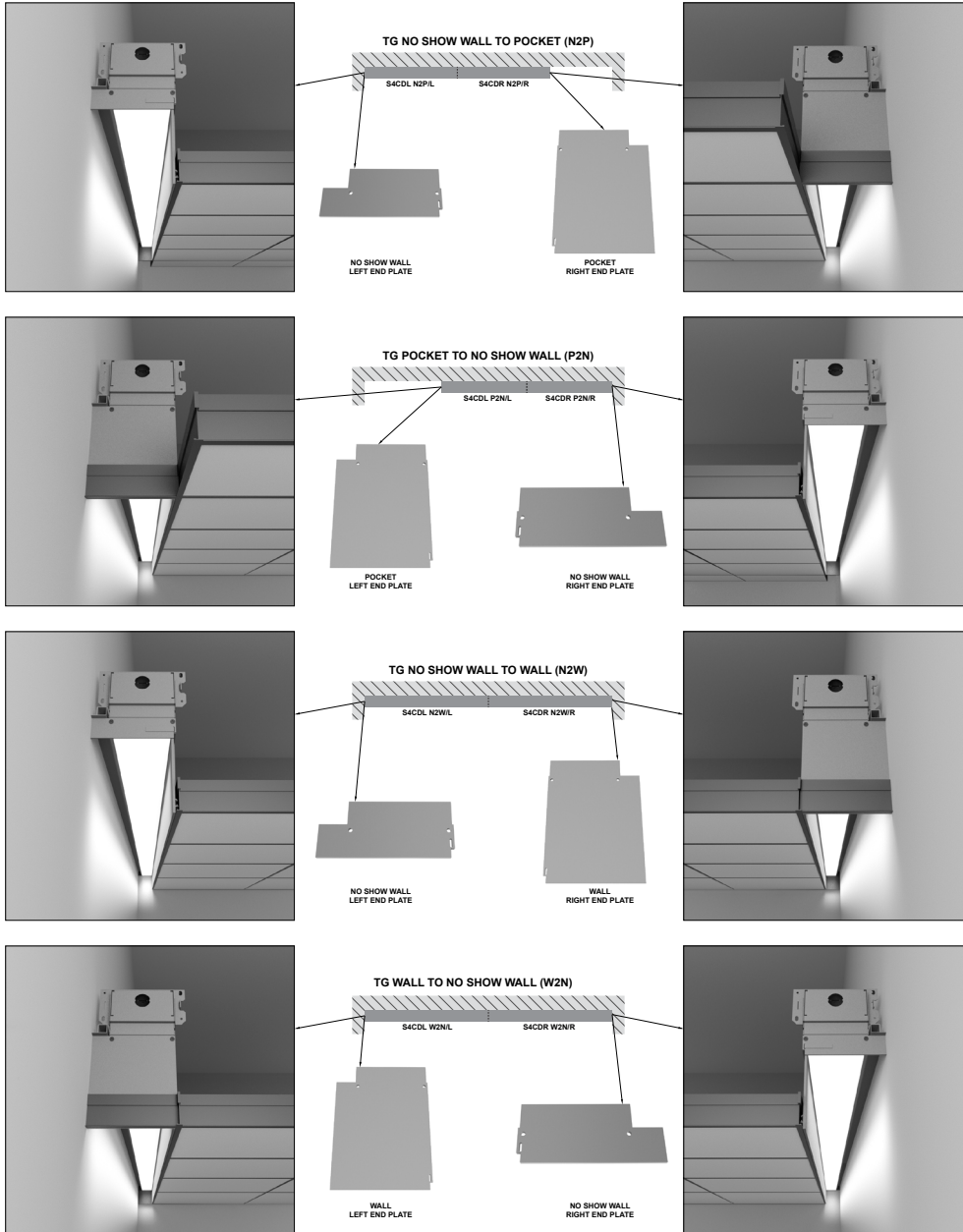

INTELLIGENT LUMINAIRE GUIDE

Choose nomenclature from these columns

	Minimum Dimming Level	Control Input	Dimming Range	Driver	Notes
Driver Configuration (MVOLT)	NODIM	(blank)		eldoLED Optotronic Oti 30/50/85	No control leads from driver
	MINIO	ZT	100% to 10%	eldoLED Optotronic Oti 30/50/85	Linear (LIN) Dimming, supplied with leads for 0-10V control
	MINI	ZT	100% to 1%	eldoLED Optotronic Oti 30/50/85	Linear (LIN) Dimming, supplied with leads for 0-10V control
	DARK	ZT	100% to 0.1%	eldoLED SOLODrive 30/50/75	Logarithmic (LOG) Dimming, supplied with leads for 0-10V control
	MINIO	NLIGHT	100% to 10%	eldoLED SOLODrive 30/50/75	Linear (LIN) Dimming, internal NIO EZ PH J100 included with luminaire
	MINI	NLIGHT	100% to 1%	eldoLED SOLODrive 30/50/75	Linear (LIN) Dimming, internal NIO EZ PH J100 included with luminaire
	DARK	NLIGHT	100% to 0.1%	eldoLED SOLODrive 30/50/75	Logarithmic (LOG) Dimming, internal NIO EZ PH J100 included with luminaire
	MINIO	NLTAIR2	100% to 10%	eldoLED SOLODrive 30/50/75	Linear (LIN) Dimming, internal RIO ZTS EXT900 ACWH 90D G2 included with luminaire
	MINI	NLTAIR2	100% to 1%	eldoLED SOLODrive 30/50/75	Linear (LIN) Dimming, internal RIO ZTS EXT900 ACWH 90D G2 included with luminaire
	DARK	NLTAIR2	100% to 0.1%	eldoLED SOLODrive 30/50/75	Logarithmic (LOG) Dimming, internal RIO ZTS EXT 900 ACWH 90D G2 included with luminaire
	DARK	DALI		eldoLED SOLODrive 30/50/75	Logarithmic (LOG) Dimming, DALI controls by others
	Driver Configuration (347)	NODIM	(blank)		eldoLED Optotronic Oti 30/50/87
MINI		ZT	100% to 1%	eldoLED Optotronic Oti 30/50/88	Linear (LIN) Dimming, supplied with leads for 0-10V control
MINIO		ZT	100% to 10%	eldoLED Optotronic Oti 30/50/89	Linear (LIN) Dimming, supplied with leads for 0-10V control

UL924 Sequence of Operation

The below information applies to all nLight AIR devices an EM option.

- EM devices will remain at their high-end trim and ignore wireless lighting control commands, unless a normal-power-sensed (NPS) broadcast is received at least every 8 seconds.
- Using the CLAIRITY+ mobile app, EM devices must be associated with a group that includes a normal power sensing device to receive NPS broadcasts.
- Only non-emergency rPP20, rLSXR, rSBOR, rSDGR, and nLight AIR luminaires with version 3.4 or later firmware can provide normal power sensing for EM devices. See specification sheets for control devices and luminaires for more information on options that support normal power sensing.

nLight® Wired Control Accessories

Order as separate catalog number

Wall Switches	Model Number
On/Off single pole	nPODMA (color)
On/Off two pole	nPODMA 2P (color)
On/Off single pole, dimming	nPODMA DX (color)
On/Off two pole, dimming	nPODMA 2P DX (color)
On/Off, two level	nPODMA 2L (color)
Graphic touchscreen	nPOD TOUCH (color)

For more information see [nPODMA](#) and [nPOD TOUCH](#) spec sheets.

nLight® Wired Control Accessories

Order as separate catalog number

Wall Switches	Model Number
On/Off single pole	rPODBA (color)
On/Off two pole	rPODBA 2P (color)
On/Off single pole, dimming	rPODBA DX (color)
On/Off two pole, dimming	rPODBA 2P DX (color)
On/Off, 4 scene control	rPODBA 4S (color)

For more information see [rPODBA](#) spec sheets

INTEGRATED CONTROLS

Optional nLight® integrated controls make Slot LED luminaires addressable- allowing them to digitally communicate with other nLight enabled controls such as dimmers, switches, occupancy sensors and photocontrols. Simply connect all the nLight enabled control devices using standard CAT5 Cabling (by others).

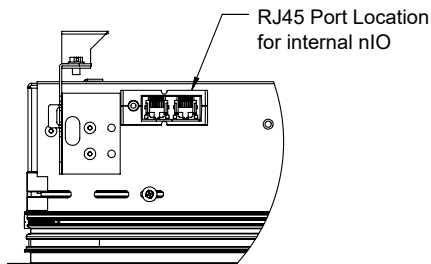

nLight Air Wireless Antenna Detail

Note: Antenna will be shipped separately and will need to be attached to the coax base.

*Images used as reference for antenna and dimension.

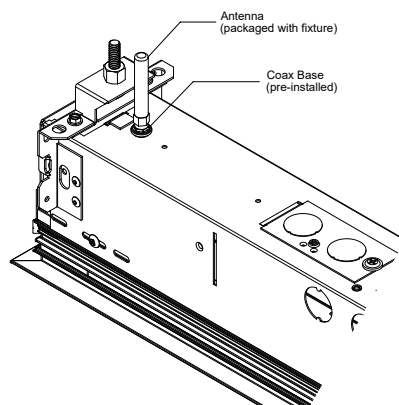
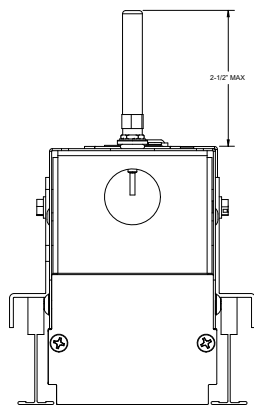

ADDITIONAL OPTIONS

Prewire Whip (PWS)

6-foot long, 3/8" diameter, (3) or (5) 18-gauge wire, 1-circuit Fixtures with PWS Option have conduit with preinstalled wires. Conduit is packed inside the same box as the fixture and it needs to be installed on the fixture by installation contractor.

*Image used as reference for prewire whip and dimension.

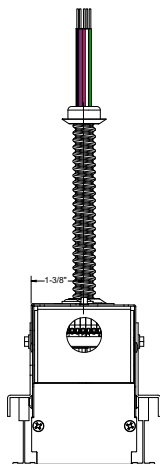

Field Adjustable (+0/-12") Section (ADJS)

Shipped as a 4, 6, 7, or 8-foot individual or end of run right side fixture. Left end of fixture is field trimmed to length. Reference page 2 ORDERING section for option exclusions.

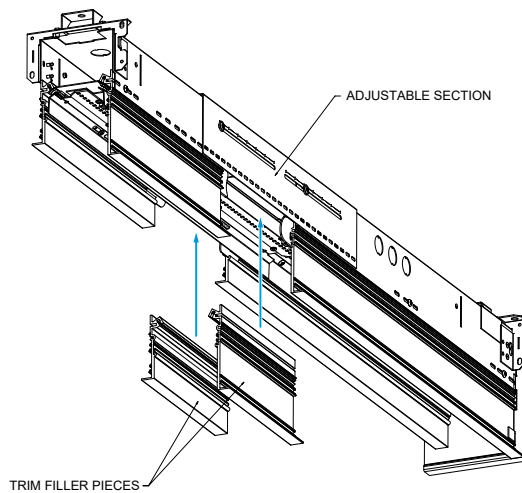

EMERGENCY OPTIONS

Emergency Battery Pack

The [PS1055LCP](#) battery is integral or remote to the fixture and comes standard with test switch and self-diagnostics. Standard emergency operation as indicated below.

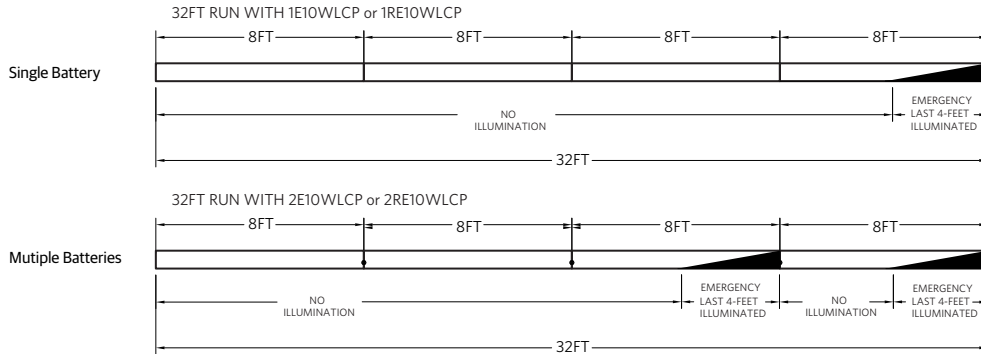

Emergency Circuits

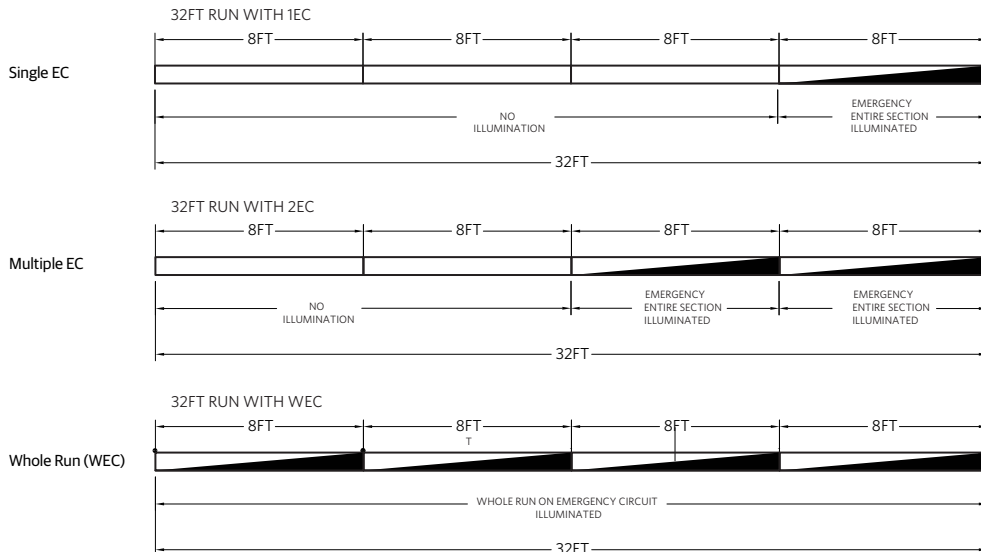

How to Estimate Delivered Lumens in Emergency Mode (E10WLCP or RE10WLCP)
Use the formula below to estimate the delivered lumens in emergency mode

Delivered Lumens = 1.25 x P x LPW
P = 10W for PS1055LCP
LPW = Lumen per watt rating of the luminaire (Available on page 1 of this spec sheet or appropriate IES file.)
(Available on page 1 of this spec sheet or appropriate IES file.)

Per tested performance data, maximum mount height of 17-feet calculated to achieve 1 footcandle (10.8 lux) of illumination below emergency battery powered fixture on the path of egress. (Based on fixture tested with 90CRI 27K LED.)
*Images used as reference for emergency test switch and dimension.

Integral Emergency Test Switch

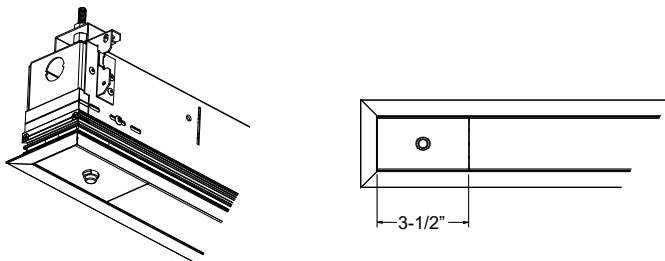

Section Length	Control Input		
	Integral (E10WLCP)	Remote (RE10WLCP)	EC
U2-U2/11.875	n/a	Entire Section Length	Entire Section Length
U3-U3/11.875	n/a	Entire Section Length	Entire Section Length
U4	Entire Section Length	Entire Section Length	Entire Section Length
U4/0.125-U4-11.875	n/a	Last 2-feet of Section Length	Entire Section Length
U5-U5/11.875	Last 3-feet of Section Length	Last 3-feet of Section Length	Entire Section Length
U6-U6/11.875	Last 3-feet of Section Length	Last 3-feet of Section Length	Entire Section Length
U7-U7/11.875	Last 4-feet of Section Length	Last 4-feet of Section Length	Entire Section Length
U8	Last 4-feet of Section Length	Last 4-feet of Section Length	Entire Section Length

EMERGENCY OPTIONS (Continued)

Remote Emergency Battery Pack

10w linear constant power emergency LED driver is remote mounted from the luminaire. The emergency driver switches power from the normal AC driver and operates the fixture for 90 minutes in the emergency mode from the unit's battery supply. Consists of (1) emergency LED driver within (1) remote mounting enclosure, flexible conduit, test switch, indicator light, cover plate and junction box supplied.

Maximum remote mounting distance from test switch to fixture not to exceed 25-feet.

The maximum emergency remote distance recommended by the manufacturer is 25-feet with 18 AWG wires.

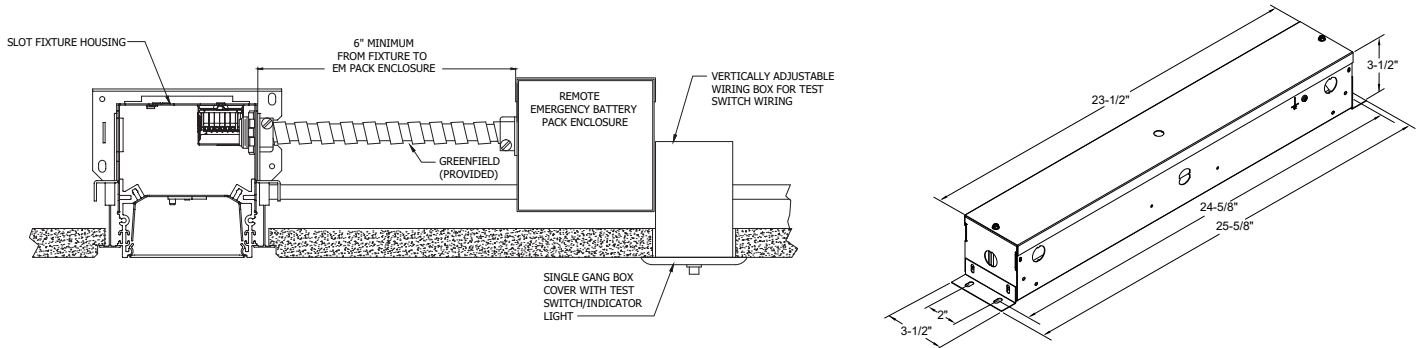

*Images used as reference for remote emergency components/box connection and dimension.

Remote GTD Mounting Option

Emergency generator transfer device is remote mounted from the luminaire. The generator transfer device senses the loss of normal AC power and switches the LED driver input power connection to an unswitched, generator (or central inverter) supplied lighting circuit bypassing the fixture wall switch. Consists of (1) emergency generator transfer device within (1) remote mounting enclosure with 6-foot long flexible conduit.

Maximum remote mounting distance is 6 feet from fixture.

*Images used as reference for remote GTD box connection and dimension.

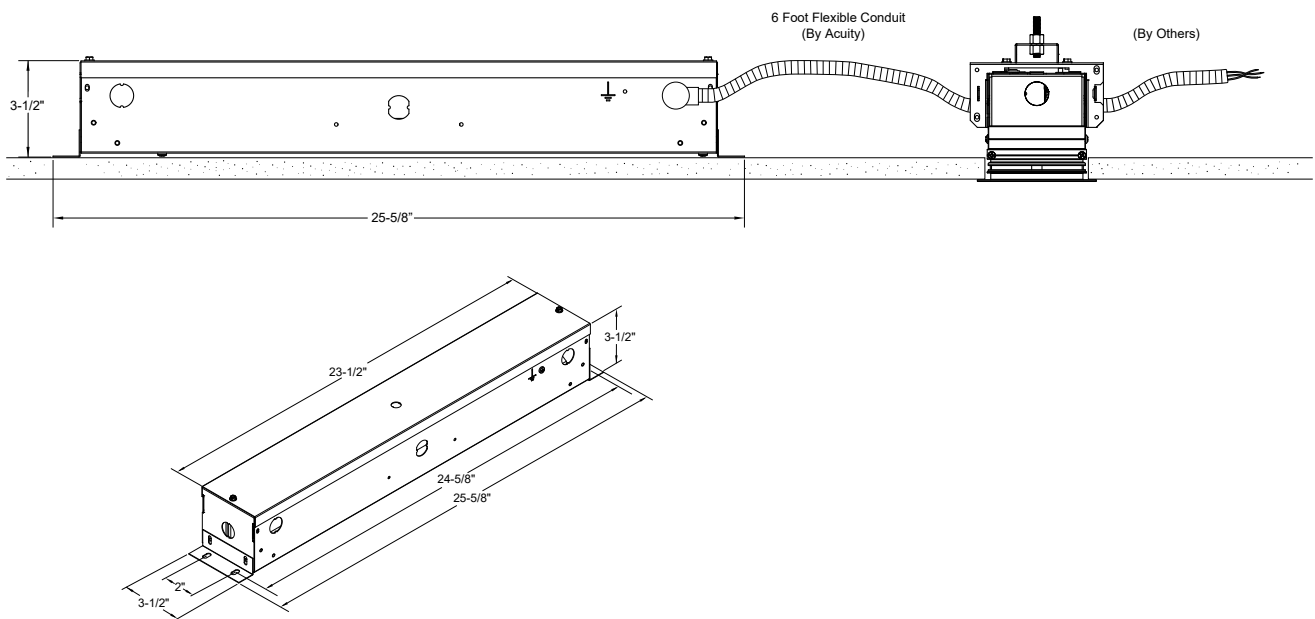

SPECIFICATIONS

Housing

Nominal 2" x 2', 3', 4', 5', 6', 7', 8' and continuous rows in 1/8" increments starting at 2', as standard. Upper housing fabricated from cold-rolled steel with extruded aluminum ceiling trim.

Finish

Standard colors for fixture trims are polyester powder coated white, antimicrobial white, black, or silver with satin sheen. Consult factory for custom colors or specify RAL colors from Architectural brochure.

Reflector

Precision-formed steel; high reflectance matte white powder coat; 93% reflectivity.

Optics (Distribution)

Wall Graze (WG) and Direct Asymmetric (DAS) incorporate co-extruded lenses and films.

Lenses/Shielding

Extruded acrylic lens, (CLL, FLL). Aluminum louver with either a powder coat finish to match housing color (LVRR) or aluminum finish (LVRRRA).

Mounting

Sheetrock: Recessed ceiling only to accommodate sheetrock, ½" minimum to 1-1/2" maximum depth for FL trim option.

Grid: To accommodate 9/16" Flat Tee with Lay-In Tile, 9/16" Flat Tee with Tegular Tile, 9/16" Slot Tee with Tegular Tile, 15/16" Flat Tee with Lay-In Tile, & 15/16" Flat Tee with Tegular Tile for TG trim option.

LED Source

Multiple lumen packages available with 2700K, 3000K, 3500K, 4000K, and 5000K CCT in 90CRI. The Acuity Brands circuit boards for the linear LED components use a precise binning algorithm which creates a consistent color temperature from board to board. Color variation of no greater than a 2.5 Step MacAdam (2.55DECM) along the black body locus from board to board.

Electrical

Long-life LEDs, coupled with high-efficiency drivers, provide superior quantity and quality of illumination for extended service life. 90% LED lumen maintenance at 60,000 hours (L90/60,000).

Circuits

Single switching option only.

Dimming Driver

Factory tuned constant current electronic dimming driver is standard. Flicker free dimming available down to <1%. LED drivers perform within the recommended operating areas for flicker as a function of frequency and modulation (%) IEEE Standard 1789-2015 (IEEE Recommended Practices for Modulating Current in High-Brightness LEDs for Mitigating Health Risks to Viewers), in typical operating conditions at representative dimming levels. Electrical specifications at maximum driver load: PF > 0.9 and THD <20%. Meets FCC Title 47 Class A or Class B. Other available drivers include Lutron and DALI protocol drivers. All drivers are RoHS compliant.

Controls System Networking Options

Optional integrated nLight® controls make each fixture addressable - allowing it to digitally communicate with other nLight enabled controls such as dimmers, switches, occupancy sensors, and photocontrols. Connection to nLight is simple. It can be accomplished with remote nLight AIR wireless or through standard Cat-5 cabling. (cabling "by others") nLight offers unique plug-and-play convenience as devices and luminaires automatically discover each other, while nLight AIR is commissioned easily through an intuitive mobile app.

Emergency Battery (Optional)

Integral emergency battery (E10WLCP) for 90 minutes of operation. Emergency battery pack, 10W, Linear Constant Power Certified in CA Title 20 MAEDBS. Integrated test switch and indicator light. Remote emergency battery (RE10WLCP) for 90 minutes of operation. Emergency battery pack, 10W, Linear Constant Power Certified in CA Title 20 MAEDBS. Remote enclosure, flexible conduit, test switch, indicator light, cover plate and junction box supplied. Remote generator transfer device (GTD) works in conjunction with an auxiliary generator or a central inverter system to power fixtures for safe egress lighting.

Ambient Operating Temperature Range

-20°C (-4° F) to +25°C (+77°F)

Environment

Suitable for damp location. Indoor use only.

Certification

CSA certified to meet U.S. and Canadian standards (UL1598 and UL8750). This product is IC rated.

Fixture Weight

Approximately 4.0 lbs per foot, less packaging.

Government Procurement

BAA - Buy America(n) Act: Product qualifies as a domestic end product under the Buy American Act as implemented in the FAR and DFARS. Product also qualifies as manufactured in the United States under DOT Buy America regulations.

BABA - Build America Buy America: Product qualifies as produced in the United States under the definitions of the Build America, Buy America Act.

Please refer to www.acuitybrands.com/buy-american for additional information.

Warranty

5-year limited warranty. This is the only warranty provided and no other statements in this specification sheet create any warranty of any kind. All other express and implied warranties are disclaimed. Complete warranty terms located at: www.acuitybrands.com/support/warranty/terms-and-conditions

Notes: Actual performance may differ as a result of end-user environment and application.

All values are design or typical values, measured under laboratory conditions at 25 °C.

Specifications subject to change without notice.