

SLOT 4

PERIMETER
DC2DC ARCHITECTURE

HIGHLIGHTS

- Compact profile
- Uniform illumination along wall surface
- Extruded aluminum and sheet metal construction
- Regressed snap-in acrylic lens
- Field adjustable telescopic end, up to 12 inches
- Driver options for Dim to Dark
- White, black or silver paint with satin finish
- UGR data available on page 4.



FIXTURE PERFORMANCE

Nominal Lumens/Foot	Direct*				
	300LMF	400LMF	600LMF	800LMF	1000LMF
Delivered Lumens/Foot	297	395	592	777	957
DC Input Watts/Foot**	2.40	3.16	4.68	6.30	7.90
Lumens/Watt	124	125	126	123	121

*Based on a 4FT 90CRI 35K fixture with 4" depth lens regress (4D), standard lambertian distribution, and flush lens (FLL)
 **Standard photometry based on AC wattage, DC wattage = AC wattage * .93.
Note: See page 6 for Device Addresses and Feed details.



DIRECT DISTRIBUTION

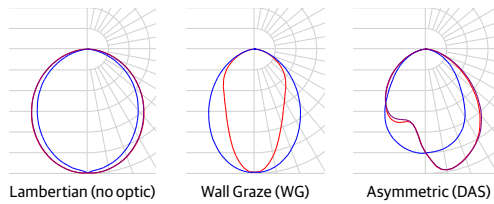

DIMENSIONS

FL Trim with 4D Lens Regress

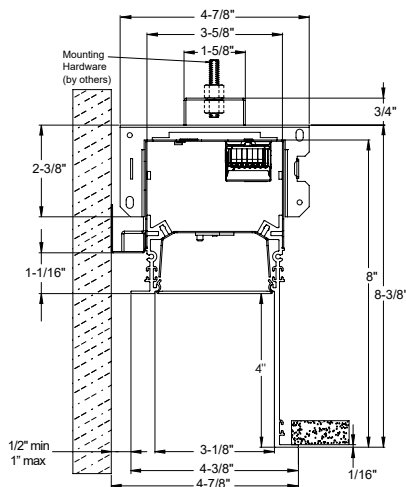

DIFFUSERS/SHIELDING

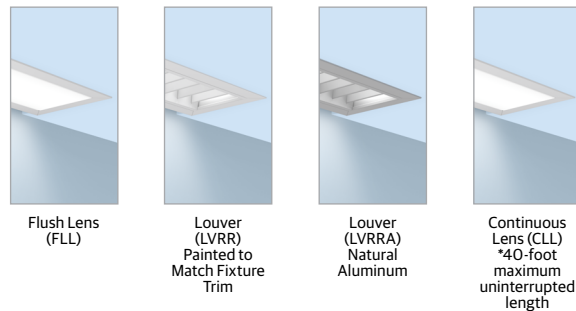

ORDERING

Example: S4CD LOP 26FT6.25 4D FL 90CRI 40K 1000LMF SCT DARK FLL 57VDC WHTT 3EC DALI W2P

--	--	--	--	--	--

Series	Linear Plan	Total Run Length	Lens Regress Depth	Mounting	Ceiling Type
S4CD Slot 4 Perimeter Direct	LOP Optimized Length	_FT_ Specify continuous linear feet to nearest 1/8" increments starting at 2FT (Example: 24' - 6 1/8" = 24FT6.125) _FT' Specify continuous linear feet to whole foot increments starting at 2FT (Example: 24' = 24FT) Unit length may affect available options. For runs longer than 8FT: ALWAYS order the run by the TOTAL RUN LENGTH. Ordering the sections individually will not provide the correct joining hardware to allow run connections in the field. 1. Use whole foot increment when using ADJS, LVRR, LVRRRA, or zoning options.	OD 0" Depth 1D' 1" Depth 4D' 4" Depth 1. Not available with Direct Distribution options.	<blank> Fixed Length ADJS^{1,2} Field Adjustable (+0/-12") Section at End of Run 1. Supplied as 4, 6, 7, or 8-foot individual or section at end of run. Left end is field trimmed to length. 2. Not available with DAS, WG or CP options in entire run.	FL 5/8IN Flange (sheetrock) TG Grid Ceiling: 9/16" Flat Tee with Lay-In Tile, 9/16" Flat Tee with Tegular Tile, 9/16" Slot Tee with Tegular Tile, 15/16" Flat Tee with Lay-In Tile, & 15/16" Flat Tee with Tegular Tile

--	--	--	--	--	--

Direct Light Source Color Rendering	Direct LED Color Temperature	Direct LED Light Output	Direct Distribution ¹	Switching	Minimum Dimming Level
90CRI 90CRI	27K 2700K 30K 3000K 35K 3500K 40K 4000K 50K 5000K	300LMF 300 Lumens per Foot 400LMF 400 Lumens per Foot 600LMF 600 Lumens per Foot 800LMF 800 Lumens per Foot 1000LMF 1,000 Lumens per Foot _LMF Specify Lumens between 300LMF and 1000LMF in 50LMF increments.	<blank> Lambertian DAS Direct asymmetric distribution WG Wall Graze Distribution 1. Direct Distribution options are only available with FLL Direct Shielding and OD Lens Regress Depth option.	SCT Single Circuit	DARK Constant Current, Dimming to 0.1%

--	--	--	--	--	--

Optional Shielding	Voltage	Finish	Emergency Battery Packs	Control Input	END Option
CLL^{3,5} Continuous Flush Lens FLL⁴ Flush Lens LVRR^{1,2} Louver (painted same finish color as housing) LVRRRA^{1,2} Natural Aluminum Louver 1. Not available with TG trim. 2. Only available in whole foot increments. 3. CLL is not available with DAS or WG distributions. 4. When using distribution options, FLL will change to FLLC to designate a co-extruded lens with white and clear material. 5. 40-foot maximum uninterrupted length.	57VDC 57VDC, Class 2 Only	WHTT White (Satin) AMF Antimicrobial White BLKT Black (Satin) SLVT Silver (Satin) RALTB¹ RAL Paint Finish 1. RALTB ¹ is for pricing only. Replace with applicable RAL number & sheen when placing order	<blank> No Emergency Option _EC Total Number of Emergency Circuits	DALI eldoLED Driver DT6	W2W Wall to Wall (Both Ends Terminate at Wall) P2P Pocket to Pocket (Both Ends Terminate at Ceiling) N2N No Show Wall to No Show Wall (Both Ends Terminate at Wall) W2P Wall to Pocket (Start Terminates at Wall & End Terminates at Ceiling) P2W Pocket to Wall (Start Terminates at Ceiling & End Terminates at Wall) N2P No Show Wall to Pocket (Start Terminates at Wall & End Terminates at Ceiling) P2N Pocket to No Show Wall (Start Terminates at Ceiling & End Terminates at Wall) N2W No Show Wall to Wall (Both Ends Terminate at Wall) W2N Wall to No Show Wall (Both Ends Terminate at Wall)

--	--	--	--

Primary Zone ¹	Secondary Zone ¹	Tertiary Zone Indicator ¹	Options
<blank> No Primary Zone NS_ Primary Zone (Specify zone length in feet.) 1. Available in whole foot run length.	<blank> No Secondary Zone SNS_ Secondary Zone (Specify zone length in feet.) 1. Available in whole foot run length.	<blank> No Tertiary Zone TNS_ Tertiary Zone (Specify zone length in feet.) 1. Available in whole foot run length.	<blank> No Options CP¹ Chicago Plenum 1. Not available in a run with ADJS option.

PHOTOMETRICS

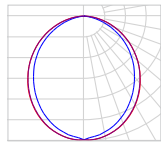

Test Report: ISF25 000625AP3048
IES LM79-08
Catalog #: S4CD 4FT OD 90CRI 35K
1000LMF STD FLL
Lumens: 4045
DC Wattage:31.62
Efficacy: 127.93

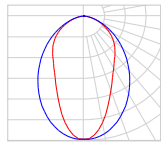

Test Report: ISF25 000817P1338
IES LM79-08
Catalog #: S4CD 4FT OD 90CRI 35K
1000LMF WG FLLC
Lumens: 3492
DC Wattage:31.62
Efficacy: 110.44

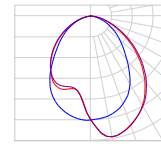

Test Report: ISF25 000819P1338
IES LM79-08
Catalog #: S4CD 4FT OD 90CRI 35K
1000LMF DAS FLLC
Lumens: 4397
DC Wattage:31.62
Efficacy: 139.06

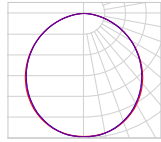

Test Report: ISF25 000816AP2293
IES LM79-08
Catalog #: S4CD 4FT OD 90CRI 35K
1000LMF STD CLL
Lumens: 4009
DC Wattage:31.62
Efficacy: 126.79

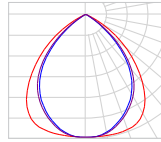

Test Report: ISF25 000822B
IES LM79-08
Catalog #: S4CD 4FT OD 90CRI 35K
1000LMF STD LVRRRA
Lumens: 2159
DC Wattage:31.62
Efficacy: 68.28

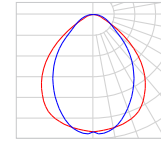

Test Report: ISF25 000821B
IES LM79-08
Catalog #: S4CD 4FT OD 90CRI 35K
1000LMF STD LVRR
Lumens: 2271
DC Wattage:31.62
Efficacy: 71.82

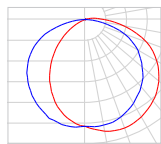

Test Report: ISF25 025332P726
IES LM79-08
Catalog #: S4CD 4FT 1D 90CRI 35K
1000LMF STD FLL
Lumens: 3918
DC Wattage:31.62
Efficacy: 123.91

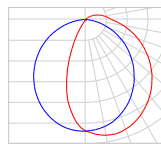

Test Report: ISF25 025338P726
IES LM79-08
Catalog #: S4CD 4FT 4D 90CRI 35K
1000LMF STD FLL
Lumens: 3827
DC Wattage:31.62
Efficacy: 121.03

PROJECT LED LUMEN MAINTENANCE

Data references the extrapolated performance projections for the platforms noted in a 25°C ambient, based on 10,000 hours of LED testing (tested per IESNA LM-80-08 and projected per IESNA TM-21-11).
To calculate LLF, use the lumen maintenance factor that corresponds to the desired number of operating hours below. For other lumen maintenance values, contact factory.

Operating Hours	0	10,000	60,000	100,000
Lumen Maintenance Factor	1	0.98	0.84	0.75

CCT SCALING CHART

CCT	CRI	MULTIPLIER	R9
27K	90CRI	0.9444	54.61
30K	90CRI	0.9722	69.01
35K	90CRI	1.0000	83.41
40K	90CRI	1.0278	91.19
50K	90CRI	1.0278	90.86

Lumen scaling charts can be used to approximate the lumen values at different Kelvin temperatures, color rendering indices, optics, or shielding.
Example: Calculating the lumen change from 90CRI 35K to 90CRI 40K = Lumen output for S4CD 4FT OD 90CRI 35K 1000LMF STD FLL (4045) x 1.0278 multiplier = 4157 lumen

OPTICAL SCALING CHARTS

DISTRIBUTIONS	MULTIPLIER
LAMBERTIAN	1.00
DAS	0.97
WG	0.80
SHIELDING	MULTIPLIER
LVRR	0.44
LVRRA	0.37
CLL	0.99
FLL	1.00

*Base fixture with Lambertian distribution and flush lens (FLL)

50LMF INCREMENT SCALING CHART

NOMINAL LMF	LUMEN	WATTAGE
	MULTIPLIER	MULTIPLIER
300LMF	0.31	0.30
350LMF	0.36	0.35
400LMF	0.41	0.40
450LMF	0.46	0.45
500LMF	0.52	0.50
550LMF	0.57	0.54
600LMF	0.62	0.59
650LMF	0.67	0.64
700LMF	0.72	0.69
750LMF	0.76	0.75
800LMF	0.81	0.80
850LMF	0.86	0.85
900LMF	0.91	0.90
950LMF	0.96	0.95
1000LMF	1.00	1.00

*Base fixture with 0" depth lens regress (OD), standard lambertian distribution, flush lens (FLL), and 1000LMF

REGRESS DEPTH SCALING CHART

LENS REGRESS DEPTH	MULTIPLIER
OD	1.00
1D	0.97
4D	0.95

*Base fixture with Lambertian distribution, 0" depth lens regress (OD), and flush lens (FLL)

UGR CHART

Lumen Package	UGR (70% 50% 20% reflectance using a 4H x 8H room size)													
	Crosswise													
	OD FLL Lambertian	OD CLL Lambertian	OD WG	OD DAS	OD LVRR	OD LVRRRA	1D FLL Lambertian	1D CLL Lambertian	1D LVRR	1D LVRRRA	4D FLL Lambertian	4D CLL Lambertian	4D LVRR	4D LVRRRA
300LMF	20.7	21.4	19.3	18.9	18.7	18.5	22.4	22.5	20.4	20.3	21	20.9	19	18.8
400LMF	21.7	22.4	20.3	19.9	19.7	19.5	23.4	23.5	21.4	21.3	22	21.9	20	19.8
600LMF	23.1	23.8	21.7	21.3	21.1	20.9	24.8	24.9	22.8	22.7	23.4	23.3	21.4	21.2
800LMF	24.1	24.7	22.7	22.3	22.1	21.9	25.8	25.8	23.8	23.6	24.3	24.3	22.3	22.1
1000LMF	24.8	25.4	23.4	23	22.8	22.6	26.5	26.5	24.5	24.3	25	25	23	22.9
Lumen Package	Endwise													
	OD FLL Lambertian	OD CLL Lambertian	OD WG	OD DAS	OD LVRR	OD LVRRRA	1D FLL Lambertian	1D CLL Lambertian	1D LVRR	1D LVRRRA	4D FLL Lambertian	4D CLL Lambertian	4D LVRR	4D LVRRRA
	300LMF	21.6	21.4	18.8	21	19.6	19.4	26.3	26.4	24.3	24.1	26.9	26.9	24.9
400LMF	22.6	22.4	19.8	21.9	20.6	20.4	27.3	27.4	25.3	25.1	27.9	27.9	25.9	25.7
600LMF	24	23.8	21.2	23.4	22	21.8	28.7	28.8	26.7	26.5	29.3	29.3	27.3	27.2
800LMF	25	24.8	22.2	24.3	23	22.8	29.7	29.7	27.7	27.5	30.3	30.2	28.3	28.1
1000LMF	25.7	25.5	22.9	25	23.7	23.5	30.4	30.4	28.4	28.2	31	31	29	28.8

*UGR varies based on luminaire options and is affected by application dependent parameters. Numbers depicted here are considered "Luminaire-UGR" and/or "Point-UGR" values. To determine a more precise maximum UGR value ("Application-UGR"), a full lighting design layout should be completed with the selected luminaire configuration for each application.

**Click here for more information on: [UGR FAQ](#)

CEILING TRIMS

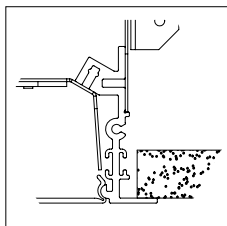

FL
5/8IN Flange (sheetrock)
Install Before Sheetrock

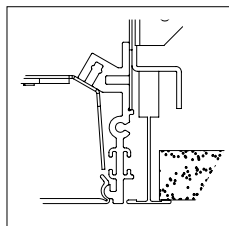

TG
9/16" Flat Tee w/ Lay-in Tile

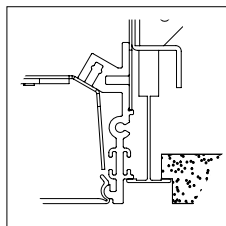

TG
9/16" Flat Tee w/ Tegular Tile

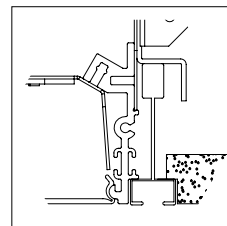

TG
9/16" Slot Tee w/ Tegular Tile

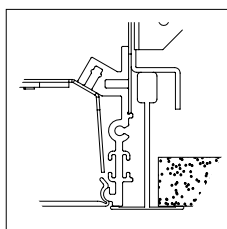

TG
15/16" Flat Tee w/ Lay-in Tile

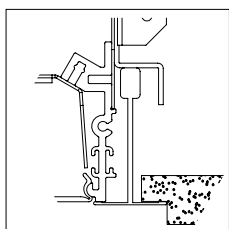

TG
15/16" Flat Tee w/ Tegular Tile

LINEAR PLAN

Mark Lighting calculates a continuous run based on optimizing fixture section length and options selected.

LOP- Linear Optimized Length

This linear plan supplies the run length based on defined length combinations, resulting in an optimized solution with the fewest segments. LOP

8FT	4FT	3FT
-----	-----	-----

Total Run Length

This system is not modular. Runs longer than 8FT will be automatically configured with left, intermediate, and right sections based on nomenclature ordered. Always order the total run length required and not individual sections.

Example: This run to be ordered as one 32FT run.

8FT	8FT	8FT	8FT
-----	-----	-----	-----

Example: This run to be ordered as four 8FT runs. Note: Individual fixtures sections cannot be joined together in the field.

8FT	8FT	8FT	8FT
-----	-----	-----	-----

MOUNTING

FL Trim Run

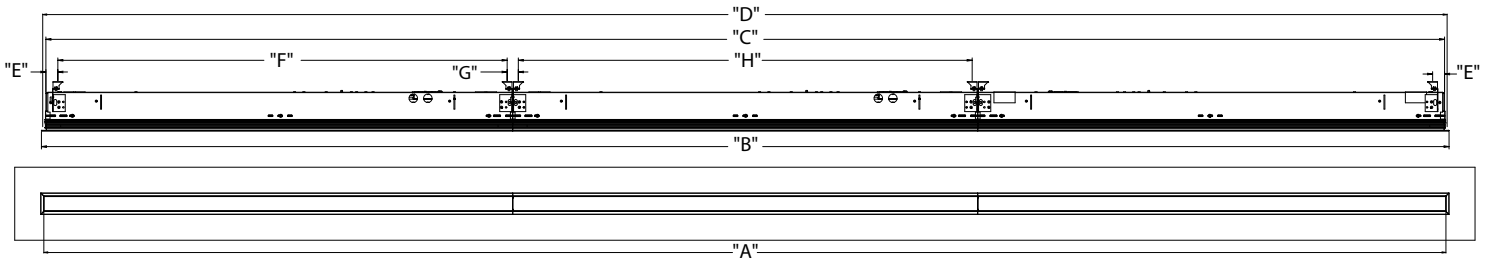

FL Run Configurations							
"A" (Illuminated Lenth)	"B" (Trim Length)	"C" (Housing Lenth)	"D" (Cut Opening Lenth)	"E" (End Mounting Location)	"F" (End Fixture Middle Mounting Point)	"G" (Mounting Point to Mounting Point)	"H" (Mounting Point to Mounting Point Intermediate Fixtures)
Order Length	Order length + 3/16" (W2W, W2N, N2W, N2N) Order length + 1 1/8" (P2P) Order length + 5/8" (W2P, P2W, N2P, P2N)	Order Length + 3/8"	Order length + 13/16"	13/16"	Fixture length - 1 1/2"	1 1/16"	Fixture length - 1 1/16"

TG Trim Run

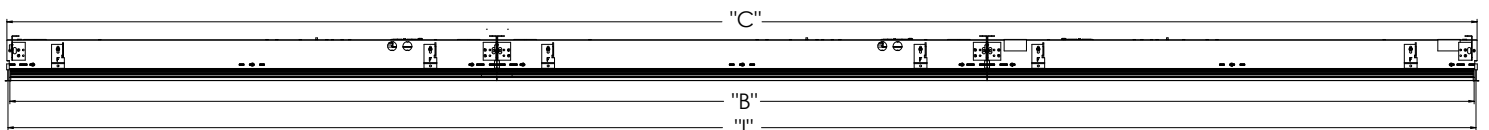

Grid Run Configurations			
"A" (Illuminated Lenth)	"B" (Trim Length)	"C" (Housing Lenth)	"I" (Grid Center to Center)
Order Length - 13/16"	Ordered Length - 5/8"	Order length - 1/32"	Order length + 13/16"

MOUNTING (continued)

Ceiling Cut Out Dimensions

		2-Foot	3-Foot	4-Foot	5-Foot	6-Foot	7-Foot	8-Foot
TG (BASED ON GRID CENTERLINE TO WALL SPACING)	GRID CL LENGTH(IN)	24	36	48	60	72	84	96
	GRID CL WIDTH(IN)	4.75-5.2	4.75-5.2	4.75-5.2	4.75-5.2	4.75-5.2	4.75-5.2	4.75-5.2
FL	LENGTH(IN) - W2W, W2N, N2W, N2N	24.18	36.18	48.18	60.18	72.18	84.18	96.18
	LENGTH(IN) - P2P	24.375	36.375	48.375	60.375	72.375	84.375	96.375
	LENGTH(IN) - W2P, P2W, N2P, P2N	24.25	36.25	48.25	60.25	72.25	84.25	96.25
	WIDTH(IN)	4.93-5.38	4.93-5.38	4.93-5.38	4.93-5.38	4.93-5.38	4.93-5.38	4.93-5.38

CEILING OPENING DIMENSIONS FOR INSTALLATION, +0.13"/-0.00"

FIXTURE DIMENSIONS AND WEIGHTS

			2-Foot	3-Foot	4-Foot	5-Foot	6-Foot	7-Foot	8-Foot
Individual	GRID CL (IN)		24	36	48	60	72	84	96
	OVERALL LENGTH (IN)		23.375	35.375	47.375	59.375	71.375	83.375	95.375
	HOUSING LENGTH (IN)		23.969	35.969	47.969	59.969	71.969	83.969	95.969
	APERTURE (IN)		23.165	35.165	47.165	59.165	71.165	83.165	95.165
TG Left or Right	GRID CL(IN)		24	36	48	60	72	84	96
	PRODUCT LENGTH(IN)		23.688	35.688	47.688	59.688	71.688	83.688	95.688
	HOUSING LENGTH(IN)		23.969	35.969	47.969	59.969	71.969	83.969	95.969
	APERTURE(IN)		23.567	35.567	47.567	59.567	71.567	83.567	95.567
Intermediate	GRID CL(IN)		24	36	48	60	72	84	96
	PRODUCT LENGTH(IN)		24	36	48	60	72	84	96
	HOUSING LENGTH(IN)		23.969	35.969	47.969	59.969	71.969	83.969	95.969
	APERTURE(IN)		24	36	48	60	72	84	96

			2-Foot	3-Foot	4-Foot	5-Foot	6-Foot	7-Foot	8-Foot
Individual	APERTURE(IN)		24	36	48	60	72	84	96
	PRODUCT LENGTH(IN) - W2W, W2N, N2W, N2N		24.180	36.180	48.180	60.180	72.180	84.180	96.180
	PRODUCT LENGTH(IN) - P2P		25.125	37.125	49.125	61.125	73.125	85.125	97.125
	PRODUCT LENGTH(IN) - W2P, P2W, N2P, P2N		24.652	36.652	48.652	60.652	72.652	84.652	96.652
	HOUSING LENGTH(IN)		24.375	36.375	48.375	60.375	72.375	84.375	96.375
FL Left	APERTURE(IN)		24	36	48	60	72	84	96
	PRODUCT LENGTH(IN) - W2x, N2x		24.090	36.090	48.090	60.090	72.090	84.090	96.090
	PRODUCT LENGTH(IN) - P2x		24.562	36.562	48.562	60.562	72.562	84.562	96.562
	HOUSING LENGTH(IN)		24.188	36.188	48.188	60.188	72.188	84.188	96.188
Right	APERTURE(IN)		24	36	48	60	72	84	96
	PRODUCT LENGTH(IN) - x2W, x2N		24.090	36.090	48.090	60.090	72.090	84.090	96.090
	PRODUCT LENGTH(IN) - x2P		24.562	36.562	48.562	60.562	72.562	84.562	96.562
	HOUSING LENGTH(IN)		24.188	36.188	48.188	60.188	72.188	84.188	96.188
Intermediate	APERTURE(IN)		24	36	48	60	72	84	96
	PRODUCT LENGTH(IN)		24	36	48	60	72	84	96
	HOUSING LENGTH(IN)		23.969	35.969	47.969	59.969	71.969	83.969	95.969

*All values rounded to +/- 1/16"

Approximate Fixture Section Weights		2-Foot	3-Foot	4-Foot	5-Foot	6-Foot	7-Foot	8-Foot
	WEIGHT(LBS)	11	14	17	24	27	30	34

DIRECT SHIELDING & OPTIONS

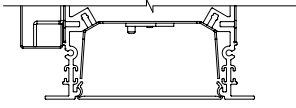

Flush Lens (FLL)
Continuous Lens (CLL)

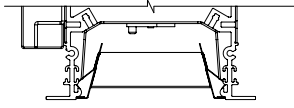

Louver (LVRR)
Aluminum Louver
(LVRR) Painted

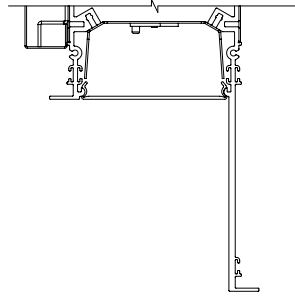

4" Regress with
FLL or CLL

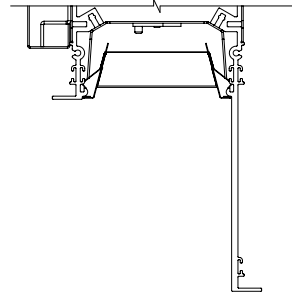

4" Regress with
LVRR or LVRR

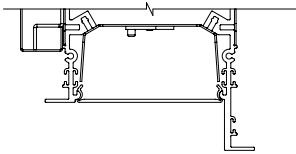

1" Regress with
FLL or CLL

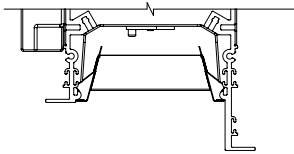

1" Regress with
LVRR or LVRR

DIRECT DISTRIBUTION

Optical Film for DAS and WG distributions with co-extruded lens standard.
Direction of light for DAS or WG distribution will be in the direction of the notches on the film.

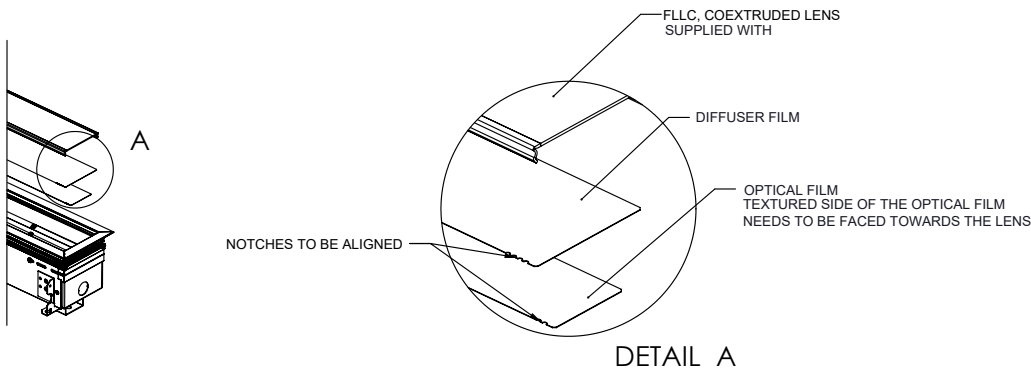

Optical Film	Number of Notches
Diffuser	4
Direct Asymmetric (DAS)	1
Wall Graze (WG)	3

CONTINUOUS LENS

40-foot maximum uninterrupted length. From 40-foot 1/8-inch to 106-foot, visible joiner required and supplied with lens rolls. Joiner will match color of trim. Continuous lens and joiners, if required, ship separate from the fixture. Reference installation instructions for further details and steps.

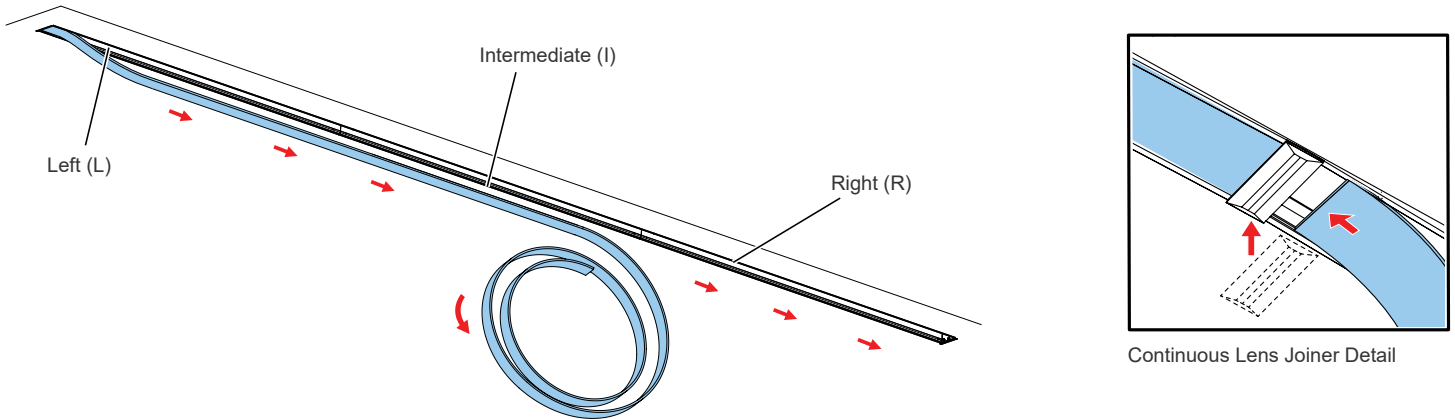

RUN PATTERNS, CORNERS, & JUNCTIONS

Patterns can be configured in 1' increments with illuminated L (corner), X, Y, & T connectors. Standard corner has 2' leg segments. Standard L (corner) connector angles are available in 40-179 degrees in 1 degree increments. Standard T & Y connector angles are available in 40-179 degrees in 1 degree increments. Standard X connector angle available in 40-90 degrees in 1 degree increments.

See separate pattern spec sheet for more details.

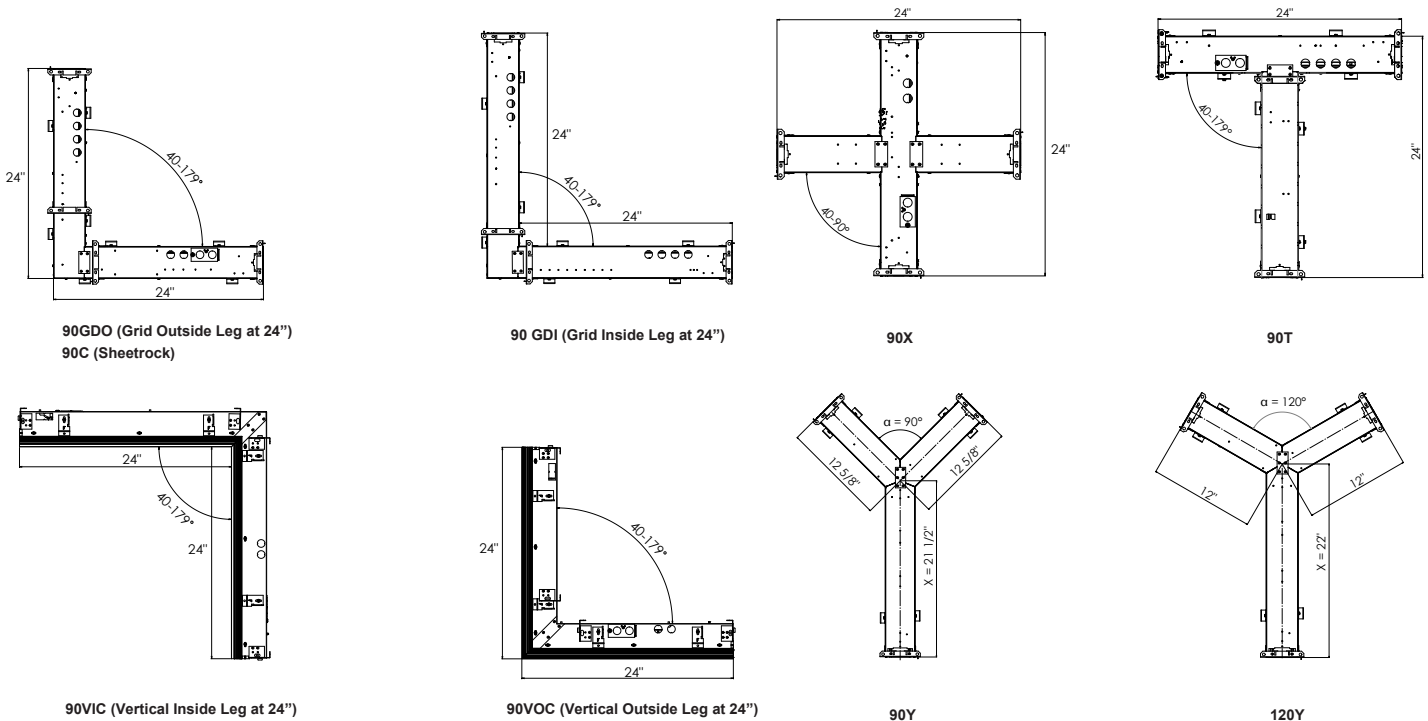

NOTE: For Y intersections, dimension X varies depending on the angle α . Angle α can be in a range of 40-179°.

ENDPLATE DETAIL

FL Trim Run

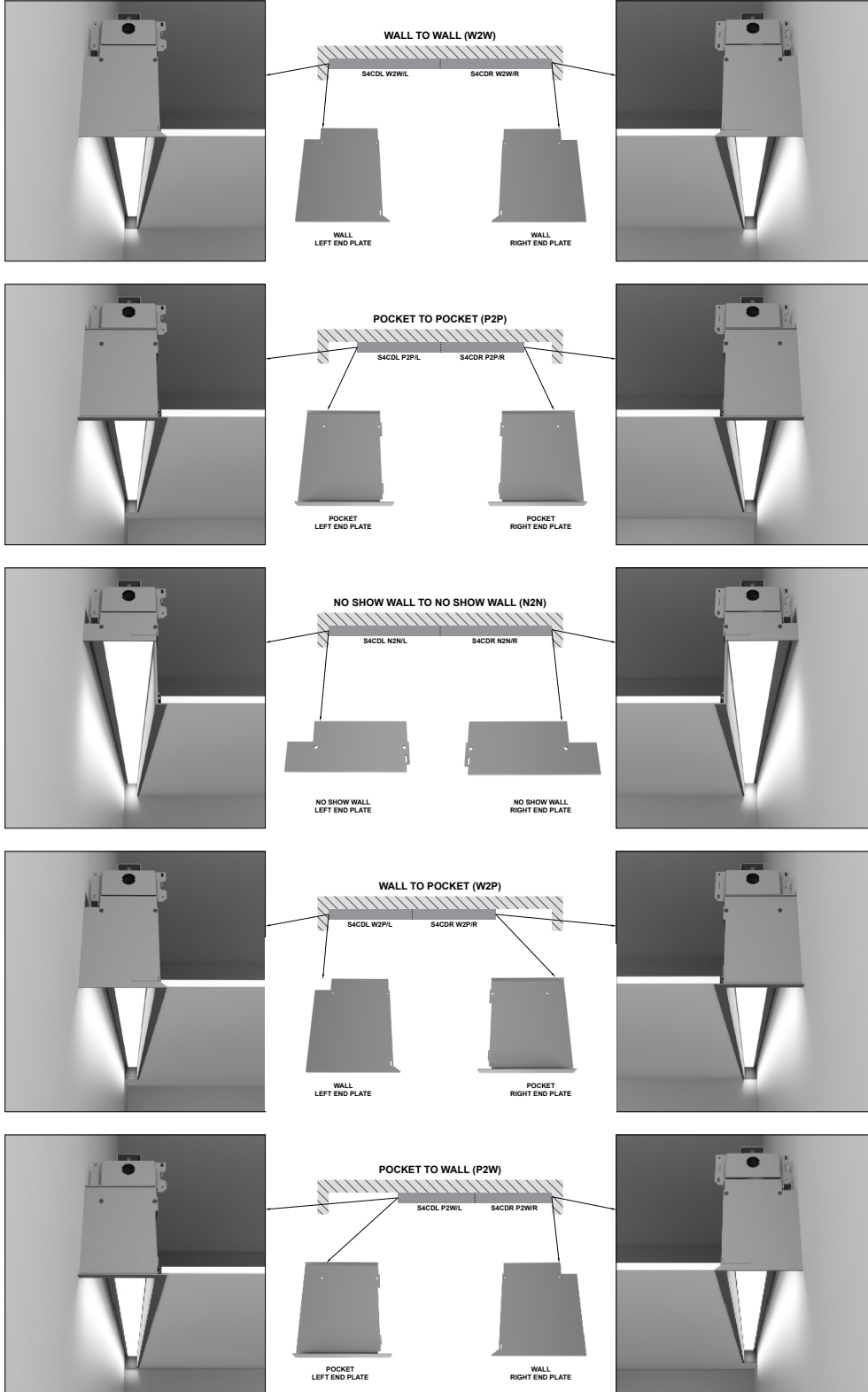

ENDPLATE DETAIL (continued)

FL Trim Run

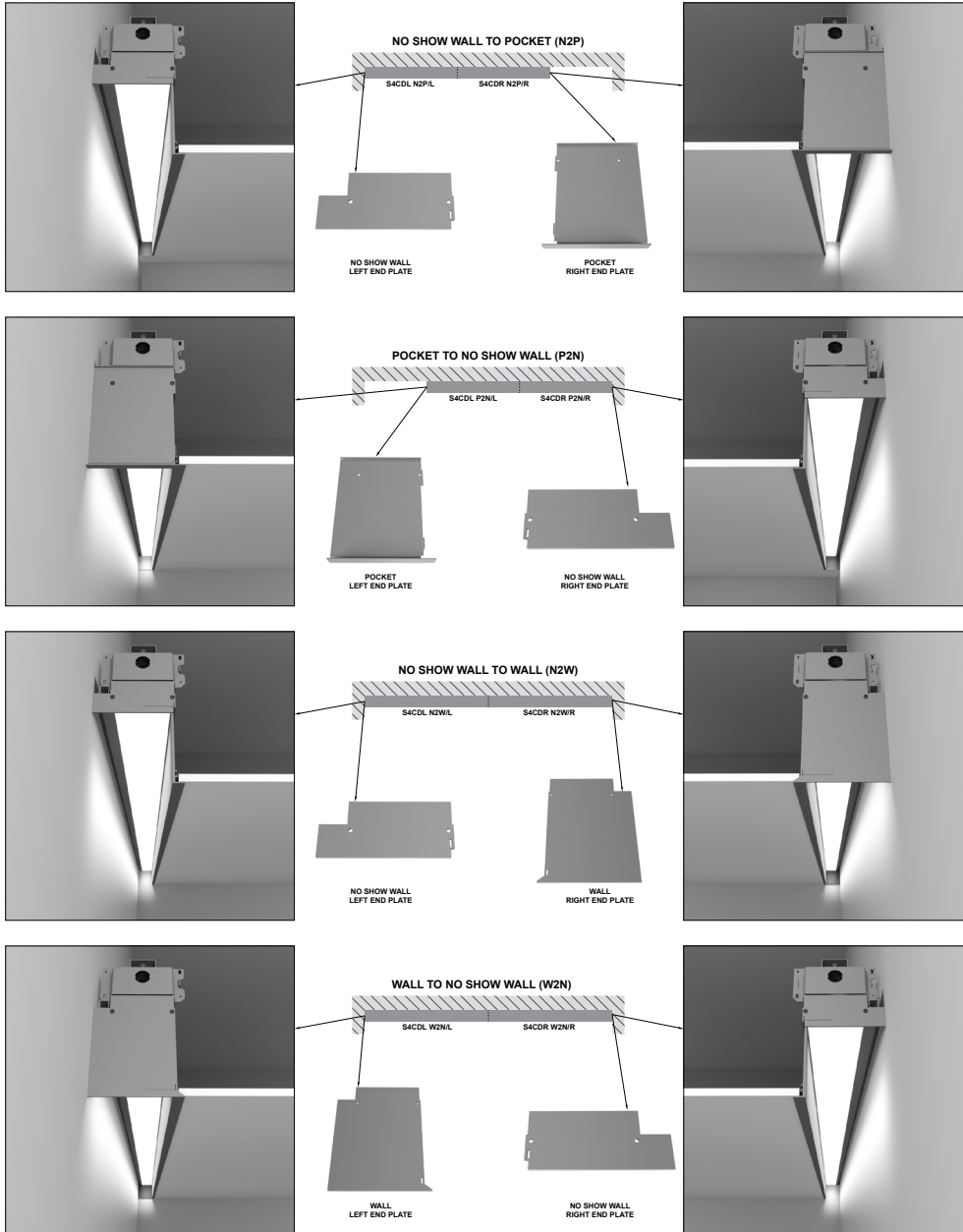

ENDPLATE DETAIL (continued)

TG Trim Run

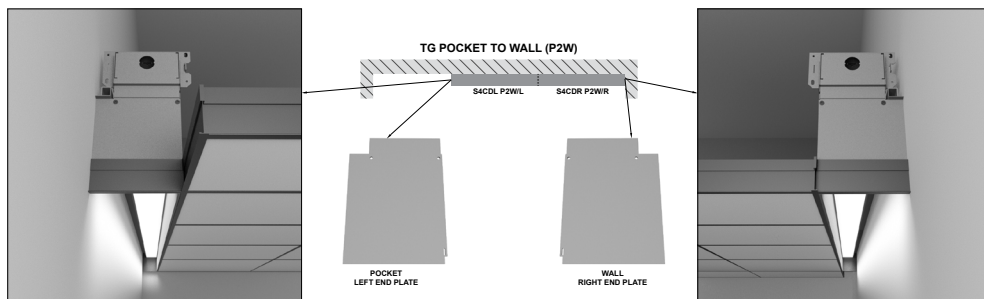
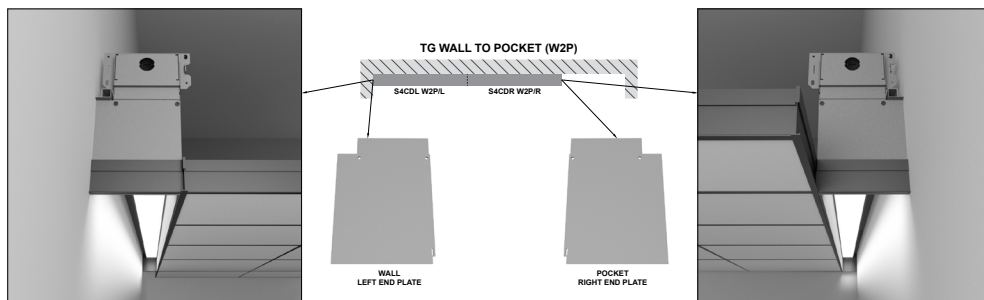
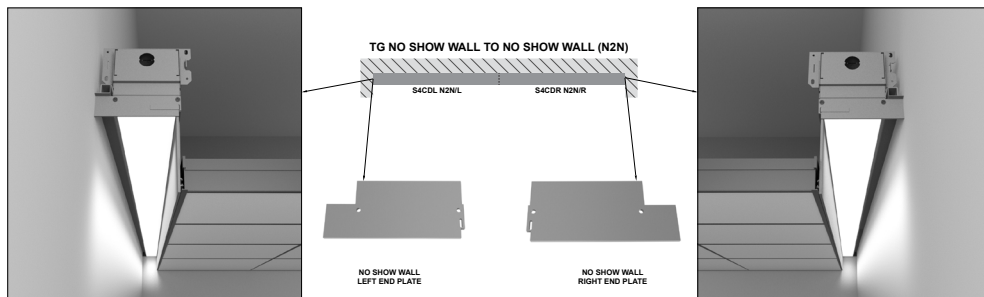
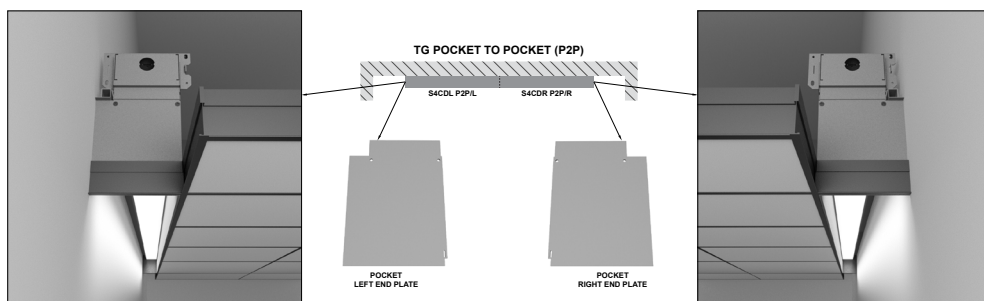
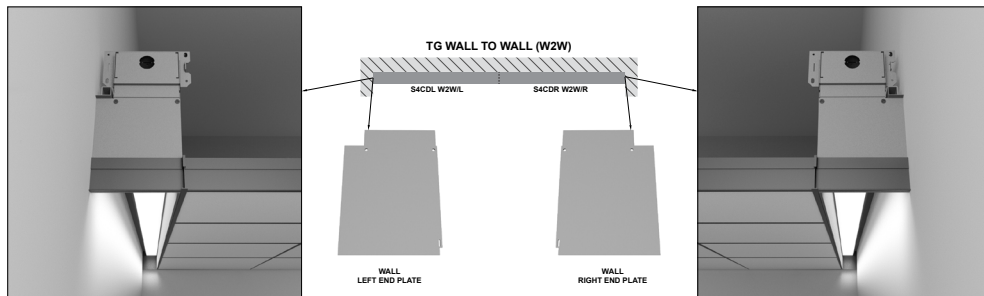

ENDPLATE DETAIL (continued)

TG Trim Run

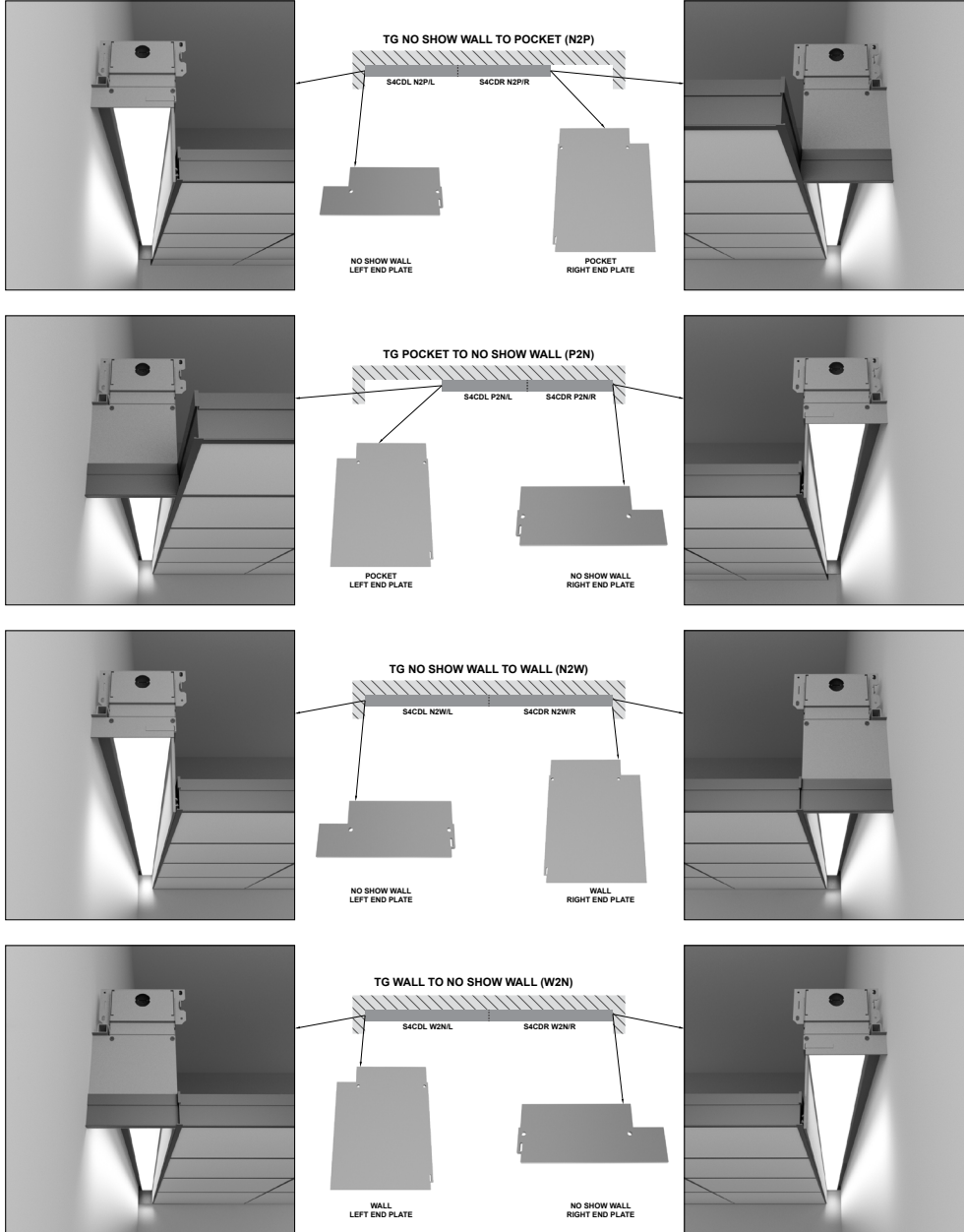

ADDITIONAL OPTIONS

Field Adjustable (+0/-12") Section (ADJS)

Shipped as a 4, 6, 7, or 8-foot individual or end of run right side fixture.
Left end of fixture is field trimmed to length. Reference page 2 ORDERING
section for option exclusions.

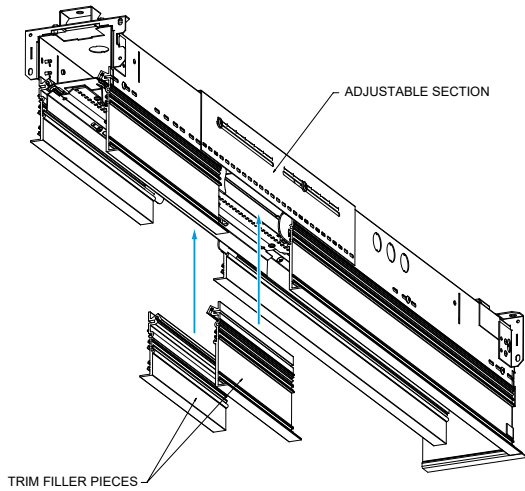

EMERGENCY OPTIONS

Emergency Circuits

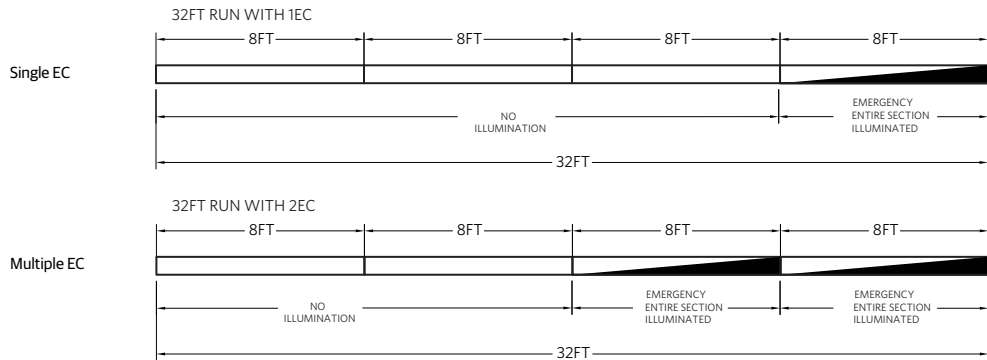

Control Input	
Section Length	EC
U2-U2/11.875	Entire Section Length
U3-U3/11.875	Entire Section Length
U4	Entire Section Length
U4/0.125-U4-11.875	Entire Section Length
U5-U5/11.875	Entire Section Length
U6-U6/11.875	Entire Section Length
U7-U7/11.875	Entire Section Length
U8	Entire Section Length

INTELLIGENT LUMINAIRE GUIDE

Choose nomenclature from these columns

Driver Configurations	Minimum Dimming Level	Control Input	Driver	Dimming Range	Notes
	DARK	DALI	eldoLED SOLOdrive DC Driver - Dali 2 compatible with Device Type 6 (DT6) functionality	100% to 0.1%	Logarithmic Dimming

DC2DC

DC-powered Lighting, DC2DC Architecture

Acuity Brands' DC2DC architecture provides for distributed low-voltage DC power and digital controls for a range of LED luminaires, including the S4CD.

The DC2DC architecture enhances an LED lighting system's efficiency by eliminating the need and cost to convert AC to DC power at the luminaire and facilitating the installation and commissioning of lighting controls. Intrinsically more efficient by design, our DC-powered lighting architecture also delivers savings at design and installation, facilitates maintenance, and empowers lighting design focused on sustainable and well-being applications.

Components include:

- DCHUB (ordered separately), distributes DC power up to 1080 VA of DC-powered LED luminaires including support for emergency lighting.
- 57 VDC powered LED luminaires, with Static CCT or Tunable White, based on control options.
- nLight® lighting control
- Integral or offboard wired networked lighting control, with nLight control devices (ordered separately).
- Embedded nLight AIR wireless devices in 57VDC powered Static CCT LED luminaires.
- Class 2 power and control cables.
- The number of luminaires that can be supported by a single DCHUB port is a function of luminaire wattage and conductor losses. Please refer to the fixture wattages listed and the DCHUB spec sheet for additional details. Alternatively, the LED luminaires can be supplied with an approved, UL Listed, Class 2 power source supplying between 52.3 and 57.0 VDC at the input to the luminaire.

Note:

All luminaires require 57VDC option along with the corresponding Control Input option for DALI or DALI8 external nPS80 DALI 57VDC wired nLight control or NLTAIR2 or NLTAIREM2 embedded wireless lighting control.

When using external wired nLight control, nPS80 DALI 57 VDC is mounted locally with the controlled luminaires. Only 2 #16 AWG (min.) conductors are necessary between the DC power source and the nPS80 DALI controller, and 4 conductors between the controller and the luminaires.

When using nLight embedded wireless controls only 2 #16 AWG (min.) conductors are necessary between the DC power source and the luminaire runs.

Click [DC2DC](#) for more information.

FIXTURE PERFORMANCE, DEVICE ADDRESSES, & FEED CHART¹

		Slot 4 Perimeter Direct ¹				
Nominal Lumens/Foot		300LMF	400LMF	600LMF	800LMF	1000LMF
Delivered Lumens/Foot		297	395	592	777	957
DC Input Watts/Foot ²		2.40	3.16	4.68	6.30	7.90
Lumens/Watt		124	125	126	123	121
# Device Addresses and Feeds	2FT	1	1	1	1	1
	3FT	1	1	1	1	1
	4FT	1	1	1	1	1
	5FT ³	2	2	2	2	2
	6FT ⁴	2	2	2	2	2
	7FT ⁵	2	2	2	2	2
	8FT ⁴	2	2	2	2	2

Notes

1. Based on a 4FT 90CRI 35K fixture with 4" depth lens regress (4D), standard lambertian distribution, and flush lens (FLL). Consult factory for other section lengths.
2. Standard photometry based on AC wattage, DC wattage = AC wattage * .93
3. For 5ft fixtures with two feeds, wattage for Feed 1 is 3/5 of the total wattage and for Feed 2 is 2/5 of the total wattage
4. For 6ft and 8ft fixtures with two feeds, wattage per feed is half of the total wattage
5. For 7ft fixtures with two feeds, wattage for Feed 1 is 4/7 of the total wattage and for Feed 2 is 3/7 of the total wattage

General Note: Combine feeds based on maximum port supply wattage or as shown on drawings. Refer to Mark Linear Submittal drawings for additional feed configuration information.

Example Calculation:

8FT 1000LMF

Device Addresses and Feeds: 2 Addresses and Feeds

Total Wattage: 7.90 W/FT x 8FT = 63.2W
 Feed 1: 4/8 x 63.2W = 31.6W
 Feed 2: 4/8 x 63.2W = 31.6W

SPECIFICATIONS

Housing

Nominal 4" x 2', 3', 4', 5', 6', 7', 8' and continuous rows in 1/8" increments starting at 2', as standard. Upper housing fabricated from cold-rolled steel with extruded aluminum ceiling trim.

Finish

Standard colors for fixture trims are polyester powder coated white, anti-microbial white, black, or silver with satin sheen. Consult factory for custom colors or specify RAL colors from Architectural brochure.

Reflector

Precision-formed steel; high reflectance matte white powder coat; 93% reflectivity.

Optics (Distribution)

Wall Graze (WG) and Direct Asymmetric (DAS) incorporate co-extruded lenses and films.

Lenses/Shielding

Extruded acrylic lens, (CLL, FLL). Aluminum louver with either a powder coat finish to match housing color (LVRR) or aluminum finish (LVRRRA).

Mounting

Sheetrock: Recessed ceiling only to accommodate sheetrock, 1/2" minimum to 1-1/2" maximum depth for FL trim option.

Grid: To accommodate 9/16" Flat Tee with Lay-In Tile, 9/16" Flat Tee with Tegular Tile, 9/16" Slot Tee with Tegular Tile, 15/16" Flat Tee with Lay-In Tile, & 15/16" Flat Tee with Tegular Tile for TG trim option.

LED Source

Multiple lumen packages available with 2700K, 3000K, 3500K, 4000K, and 5000K CCT in 90CRI. The Acuity Brands circuit boards for the linear LED components use a precise binning algorithm which creates a consistent color temperature from board to board. Color variation of no greater than a 2.5 Step MacAdam (2.55DECM) along the black body locus from board to board.

Electrical

Long-life LEDs, coupled with high-efficiency drivers, provide superior quantity and quality of illumination for extended service life. 90% LED lumen maintenance at 60,000 hours (L90/60,000).

Circuits

Single switching option only.

Dimming Driver

eldoLED constant current driver options deliver choice of dimming range for ultrasmooth dimming resolution from 100% to less than 1% , and choices for control, while assuring flicker free, low current inrush, 89% efficiency and low EMI. Luminaires operate over a voltage ranging from 53VDC to 57VDC.

Ambient Operating Temperature Range

-20°C (-4° F) to +25°C (+77°F)

Environment

Suitable for damp location. Indoor use only.

Certification

CSA certified to meet U.S. and Canadian standards (UL1598 and UL8750). This product is IC rated.

Fixture Weight

Approximately 4.0 lbs per foot, less packaging.

Warranty

5-year limited warranty. This is the only warranty provided and no other statements in this specification sheet create any warranty of any kind. All other express and implied warranties are disclaimed. Complete warranty terms located at: www.acuitybrands.com/support/warranty/terms-and-conditions

Notes: Actual performance may differ as a result of end-user environment and application.

All values are design or typical values, measured under laboratory conditions at 25°C.

Specifications subject to change without notice