

# SLOT 4

PERIMETER  
TUNABLE WHITE

## HIGHLIGHTS

- Compact profile
- Uniform illumination along wall surface
- Extruded aluminum and sheet metal construction
- Regressed snap-in acrylic lens
- Field adjustable telescopic end, up to 12 inches
- Mainstream Dynamic Tunable White with nTune™ Technology
- White, black or silver paint with satin finish
- UGR data available on page 4.



## FIXTURE PERFORMANCE

Nominal Lumens/Foot	Direct*											
	300LMF			400LMF			600LMF			800LMF		
CCT	27K	46K	65K	27K	46K	65K	27K	46K	65K	27K	46K	65K
Delivered Lumens/Foot	283	289	314	388	382	417	599	568	625	810	753	832
Input Watts/Foot	2.52	2.50	2.72	3.52	3.28	3.67	5.51	4.84	5.57	7.50	6.41	7.48
Lumens/Watt	112	116	115	110	116	114	109	117	112	108	117	111

Nominal Lumens/Foot	Direct*								
	1000LMF			1200LMF			1300LMF		
CCT	27K	46K	65K	27K	46K	65K	27K	46K	65K
Delivered Lumens/Foot	987	948	1011	1113	1083	1133	1176	1150	1194
Input Watts/Foot	9.20	8.01	9.13	10.84	9.36	10.62	11.66	10.03	11.36
Lumens/Watt	107	118	111	103	116	107	101	115	105

Based on a 4FT 90CRI TUWH RHYR (27K-65K) fixture with 4" depth lens regress (4D), standard lambertian distribution, and flush lens (FLL)



## DIRECT DISTRIBUTION

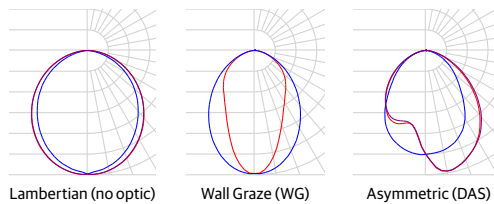

## DIMENSIONS

FL Trim with 4D Lens Regress

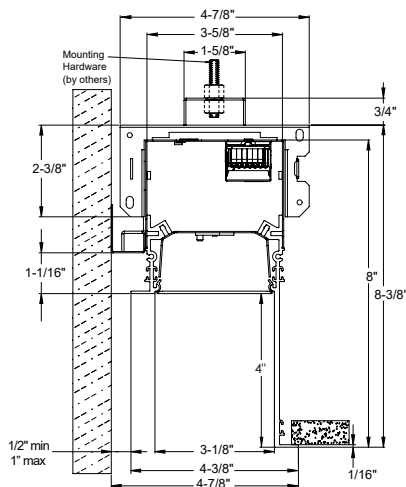

## DIFFUSERS/SHIELDING

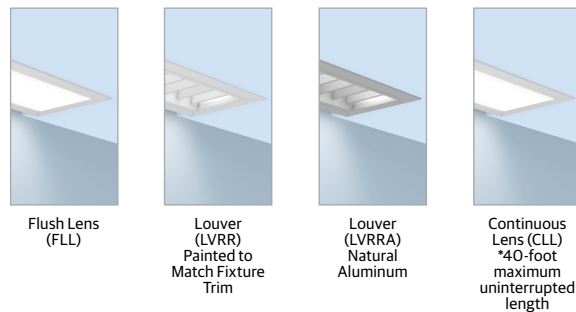

**ORDERING**

Example: S4CD LOP 38FT5.75 4D FL 90CRI TUWH RHYP 1000LMF SCT DARK CLL MVOLT AMF NLT W2W

--	--	--	--	--	--

Series	Linear Plan	Total Run Length	Lens Regress Depth	Mounting	Ceiling Type
<b>S4CD</b> Slot 4 Perimeter Direct	<b>LOP</b> Optimized Length	<b>.FT_</b> Specify continuous linear feet to nearest 1/8" increments starting at 2FT (Example: 24' - 6 1/8" = 24FT6.125) <b>.FT'</b> Specify continuous linear feet to whole foot increments starting at 2FT (Example: 24' = 24FT) Unit length may affect available options. <b>For runs longer than 8FT: ALWAYS order the run by the TOTAL RUN LENGTH. Ordering the sections individually will not provide the correct joining hardware to allow run connections in the field.</b> 1. Use whole foot increment when using ADJS, LVRR, LVRRRA, or zoning options.	<b>OD</b> 0" Depth <b>1D'</b> 1" Depth <b>4D'</b> 4" Depth 1. Not available with Direct Distribution options.	<b>&lt;blank&gt;</b> Fixed Length <b>ADJS<sup>1,2</sup></b> Field Adjustable (+0/-12") Section at End of Run 1. Supplied as a 4, 6, 7, or 8-foot individual or section at end of run. Left end is field trimmed to length. 2. Not available with DAS, WG, E10WLCP, GTD, or CP options in entire run.	<b>FL</b> 5/8IN Flange (sheetrock) <b>TG</b> Grid Ceiling: 9/16" Flat Tee with Lay-In Tile, 9/16" Flat Tee with Tegular Tile, 9/16" Slot Tee with Tegular Tile, 15/16" Flat Tee with Lay-In Tile, & 15/16" Flat Tee with Tegular Tile

--	--	--	--	--	--

Direct Light Source Color Rendering	Direct Dynamic Feature	Direct Dynamic Range	Direct LED Light Output	Direct Distribution <sup>1</sup>	Switching
<b>90CRI</b> 90CRI	<b>TUWH</b> Tunable White	<b>RHYR</b> Rhythm Range (2700K-6500K)	<b>300LMF</b> 300 Lumens per Foot <b>400LMF</b> 400 Lumens per Foot <b>600LMF</b> 600 Lumens per Foot <b>800LMF</b> 800 Lumens per Foot <b>1000LMF</b> 1,000 Lumens per Foot <b>1200LMF</b> 1,200 Lumens per Foot <b>1300LMF</b> 1,300 Lumens per Foot <b>_LMF</b> Specify Lumens between 300LMF and 1300LMF in 50LMF increments	<b>&lt;blank&gt;</b> Lambertian <b>DAS</b> Direct asymmetric distribution <b>WG</b> Wall Graze Distribution 1. Direct Distribution options are only available with FLL Direct Shielding and OD Lens Regress Depth option.	<b>SCT</b> Single Circuit

--	--	--	--	--	--

Minimum Dimming Level	Optional Shielding	Voltage	Finish	Emergency Battery Packs	Control Input
<b>DARK</b> Constant Current, Dimming to 0.1%	<b>CLL<sup>3,5</sup></b> Continuous Flush Lens <b>FLL<sup>4</sup></b> Flush Lens <b>LVRR<sup>1,2</sup></b> Louver (painted same finish color as housing) <b>LVRRRA<sup>1,2</sup></b> Natural Aluminum Louver 1. Not available with TG trim or emergency options E10WLCP or GTD. 2. Only available in whole foot increments. 3. CLL is not available with DAS or WG distributions. 4. When using distribution options, FLL will change to FLLC to designate a co-extruded lens with white and clear material. 5. 40-foot maximum uninterrupted length.	<b>MVOLT</b> 120-277V <b>120'</b> 120V <b>277'</b> 277V 1. Required with GTD option.	<b>WHIT</b> White (Satin) <b>AMF</b> Antimicrobial White <b>BLKT</b> Black (Satin) <b>SLVT</b> Silver (Satin) <b>RALTB<sup>1</sup></b> <b>RAL Paint Finish</b> 1. RALTB <sup>1</sup> is for pricing only. Replace with applicable RAL number & sheen when placing order	<b>&lt;blank&gt;</b> No Emergency Option <b>_E10WLCP<sup>1,2</sup></b> Total Number of 10W Battery Packs, Constant Power, Self Diagnostic, T20 Compliant <b>_RE10WLCP</b> Total Number of Remote 10W Battery Packs, Constant Power, Self Diagnostics, T20 Compliant <b>_EC</b> Total Number of Emergency Circuits <b>GTD<sup>2</sup></b> Generic Transfer Device 1. E10WLCP is not available in units 2' to 3'-11 7/8", 4'-0-1/8" to 4'-11 7/8", or with 1D, 4D, ADJS, LVRR, or LVRRRA options. 2. GTD is remote mounted. GTD is not available with ADJS or CP options and requires 120 or 277 voltage specified. 3. Available with maximum 1100LMF for complete linear run.	<b>NLT</b> nLight nTune Device

--	--	--	--	--	--

END Option	Primary Zone <sup>1</sup>	Secondary Zone <sup>1</sup>	Tertiary Zone Indicator <sup>1</sup>	Options
<b>W2W</b> Wall to Wall (Both Ends Terminate at Wall) <b>P2P</b> Pocket to Pocket (Both Ends Terminate at Ceiling) <b>N2N</b> No Show Wall to No Show Wall (Both Ends Terminate at Wall) <b>W2P</b> Wall to Pocket (Start Terminates at Wall & End Terminates at Ceiling) <b>P2W</b> Pocket to Wall (Start Terminates at Ceiling & End Terminates at Wall) <b>N2P</b> No Show Wall to Pocket (Start Terminates at Wall & End Terminates at Ceiling) <b>P2N</b> Pocket to No Show Wall (Start Terminates at Ceiling & End Terminates at Wall) <b>N2W</b> No Show Wall to Wall (Both Ends Terminate at Wall) <b>W2N</b> Wall to No Show Wall (Both Ends Terminate at Wall)	<b>&lt;blank&gt;</b> No Primary Zone <b>NS_</b> Primary Zone (Specify zone length in feet.) 1. Available in whole foot run length.	<b>&lt;blank&gt;</b> No Secondary Zone <b>SNS_</b> Secondary Zone (Specify zone length in feet.) 1. Available in whole foot run length.	<b>&lt;blank&gt;</b> No Tertiary Zone <b>TNS_</b> Tertiary Zone (Specify zone length in feet.) 1. Available in whole foot run length.	<b>&lt;blank&gt;</b> No Options <b>CP<sup>1,2</sup></b> Chicago Plenum <b>BAA</b> Buy America(n) Act and/or Build America Buy America Qualified 1. Not available with GTD. 2. Not available in a run with ADJS option.

**PHOTOMETRICS**

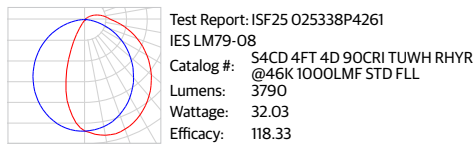
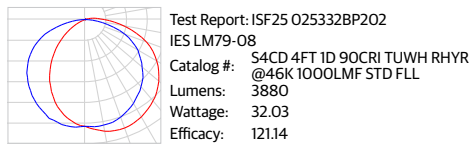
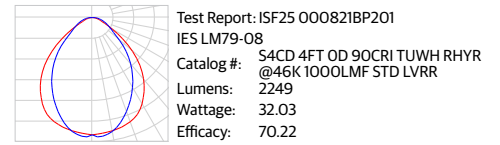
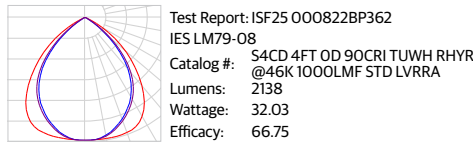
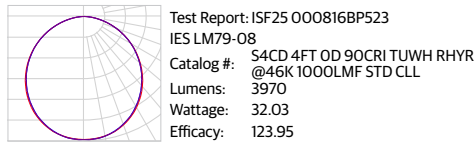
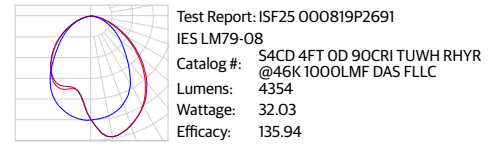
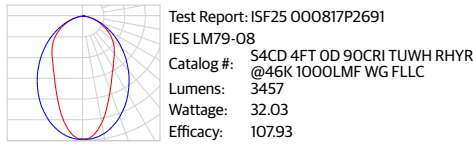
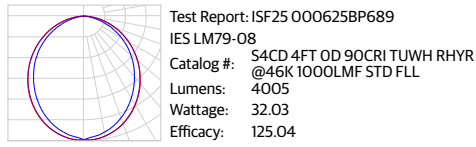

**PROJECT LED LUMEN MAINTENANCE**

Data references the extrapolated performance projections for the platforms noted in a 25°C ambient, based on 10,000 hours of LED testing (tested per IESNA LM-80-08 and projected per IESNA TM-21-11).

To calculate LLF, use the lumen maintenance factor that corresponds to the desired number of operating hours below. For other lumen maintenance values, contact factory.

<b>Operating Hours</b>	0	10,000	60,000	100,000
<b>Lumen Maintenance Factor</b>	1	0.98	0.84	0.75

**REGRESS DEPTH SCALING CHART**

LENS REGRESS DEPTH	MULTIPLIER
OD	1.00
1D	0.97
4D	0.95

\*Base fixture with Lambertian distribution, 0" depth lens regress (OD), and flush lens (FLL)

**OPTICAL SCALING CHARTS**

DISTRIBUTIONS	MULTIPLIER
LAMBERTIAN	1.00
DAS	0.97
WG	0.80
SHIELDING	MULTIPLIER
LVRR	0.44
LVRRA	0.37
CLL	0.99
FLL	1.00

\*Base fixture with Lambertian distribution and flush lens (FLL)

**50LMF INCREMENT SCALING CHART**

NOMINAL LMF	LUMEN MULTIPLIER	WATTAGE MULTIPLIER
300LMF	0.31	0.30
350LMF	0.36	0.35
400LMF	0.41	0.40
450LMF	0.46	0.45
500LMF	0.52	0.50
550LMF	0.57	0.54
600LMF	0.62	0.59
650LMF	0.67	0.64
700LMF	0.72	0.69
750LMF	0.76	0.75
800LMF	0.81	0.80
850LMF	0.86	0.85
900LMF	0.91	0.90
950LMF	0.96	0.95
1000LMF	1.00	1.00
1050LMF	1.06	1.05
1100LMF	1.11	1.10
1150LMF	1.16	1.17
1200LMF	1.21	1.24
1250LMF	1.25	1.30
1300LMF	1.30	1.37

\*Base fixture with 0" depth lens regress (OD), standard lambertian distribution, flush lens (FLL), and 1000LMF

**TUNABLE WHITE GAMUT AND RANGE**

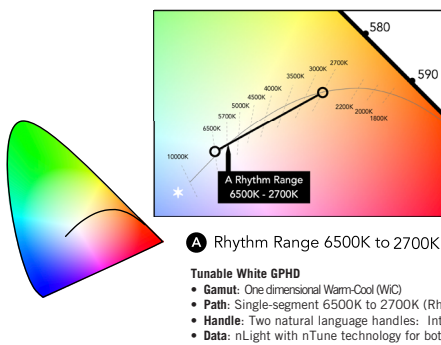

**UGR CHART**

Lumen Package	UGR (70% 50% 20% reflectance using a 4H x 8H room size)													
	Crosswise													
	OD FLL Lambertian	OD CLL Lambertian	OD WG	OD DAS	OD LVRR	OD LVRRRA	1D FLL Lambertian	1D CLL Lambertian	1D LVRR	1D LVRRRA	4D FLL Lambertian	4D CLL Lambertian	4D LVRR	4D LVRRRA
300LMF	20.7	21.4	19.3	18.9	18.7	18.5	22.4	22.5	20.4	20.3	21	20.9	19	18.8
400LMF	21.7	22.4	20.3	19.9	19.7	19.5	23.4	23.5	21.4	21.3	22	21.9	20	19.8
600LMF	23.1	23.8	21.7	21.3	21.1	20.9	24.8	24.9	22.8	22.7	23.4	23.3	21.4	21.2
800LMF	24.1	24.7	22.7	22.3	22.1	21.9	25.8	25.8	23.8	23.6	24.3	24.3	22.3	22.1
1000LMF	24.8	25.4	23.4	23	22.8	22.6	26.5	26.5	24.5	24.3	25	25	23	22.9
1200LMF	25.4	26.1	24.1	23.6	23.4	23.3	27.2	27.2	25.2	25	25.7	25.7	23.7	23.5
1300LMF	25.9	26.6	24.6	24.1	23.9	23.8	27.6	27.7	25.6	25.5	26.2	26.2	24.2	24
Lumen Package	Endwise													
	OD FLL Lambertian	OD CLL Lambertian	OD WG	OD DAS	OD LVRR	OD LVRRRA	1D FLL Lambertian	1D CLL Lambertian	1D LVRR	1D LVRRRA	4D FLL Lambertian	4D CLL Lambertian	4D LVRR	4D LVRRRA
	300LMF	21.6	21.4	18.8	21	19.6	19.4	26.3	26.4	24.3	24.1	26.9	26.9	24.9
400LMF	22.6	22.4	19.8	21.9	20.6	20.4	27.3	27.4	25.3	25.1	27.9	27.9	25.9	25.7
600LMF	24	23.8	21.2	23.4	22	21.8	28.7	28.8	26.7	26.5	29.3	29.3	27.3	27.2
800LMF	25	24.8	22.2	24.3	23	22.8	29.7	29.7	27.7	27.5	30.3	30.2	28.3	28.1
1000LMF	25.7	25.5	22.9	25	23.7	23.5	30.4	30.4	28.4	28.2	31	31	29	28.8
1200LMF	26.3	26.2	23.5	25.7	24.3	24.2	31	31.1	29	28.9	31.7	31.6	29.6	29.5
1300LMF	26.8	26.6	24	26.2	24.8	24.7	31.5	31.6	29.5	29.3	32.1	32.1	30.1	30

\*UGR varies based on luminaire options and is affected by application dependent parameters. Numbers depicted here are considered "Luminaire-UGR" and/or "Point-UGR" values. To determine a more precise maximum UGR value ("Application-UGR"), a full lighting design layout should be completed with the selected luminaire configuration for each application.

\*\*Click here for more information on: [UGR FAQ](#)

**CEILING TRIMS**

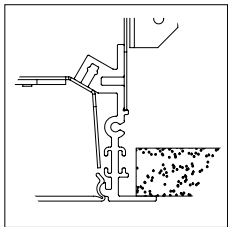

**FL**  
5/8IN Flange (sheetrock)  
Install Before Sheetrock

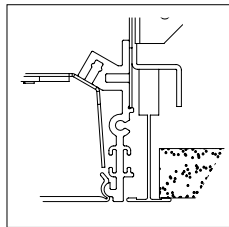

**TG**  
9/16" Flat Tee w/ Lay-in Tile

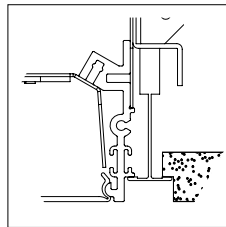

**TG**  
9/16" Flat Tee w/ Tegular Tile

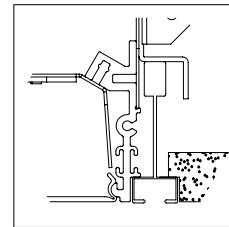

**TG**  
9/16" Slot Tee w/ Tegular Tile

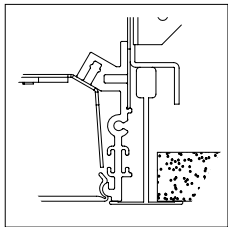

**TG**  
15/16" Flat Tee w/ Lay-in Tile

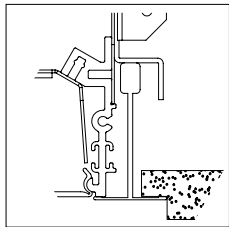

**TG**  
15/16" Flat Tee w/ Tegular Tile

**LINEAR PLAN**

Mark Lighting calculates a continuous run based on optimizing fixture section length and options selected.

**LOP- Linear Optimized Length**

This linear plan supplies the run length based on defined length combinations, resulting in an optimized solution with the fewest segments. LOP

8FT	4FT	3FT
-----	-----	-----

**Total Run Length**

This system is not modular. Runs longer than 8FT will be automatically configured with left, intermediate, and right sections based on nomenclature ordered. Always order the total run length required and not individual sections.

Example: This run to be ordered as one 32FT run.

8FT	8FT	8FT	8FT
-----	-----	-----	-----

Example: This run to be ordered as four 8FT runs. Note: Individual fixtures sections cannot be joined together in the field.

8FT	8FT	8FT	8FT
-----	-----	-----	-----

**MOUNTING**

**FL Trim Run**

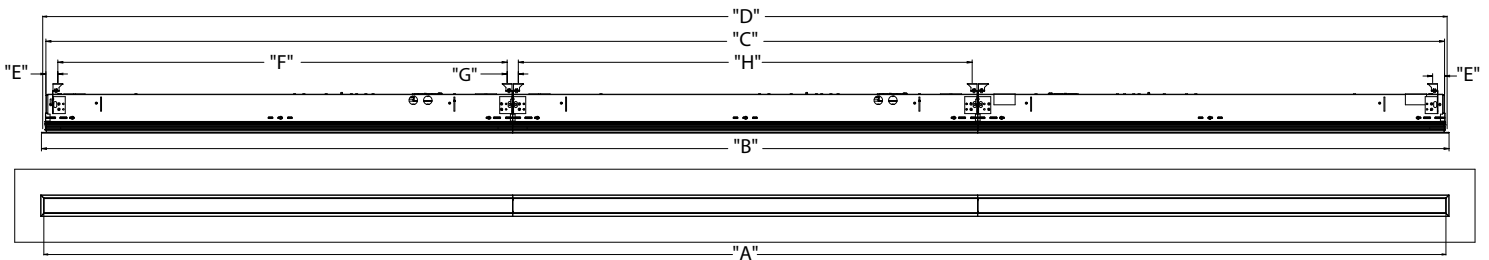

FL Run Configurations							
"A" (Illuminated Lenth)	"B" (Trim Length)	"C" (Housing Lenth)	"D" (Cut Opening Lenth)	"E" (End Mounting Location)	"F" (End Fixture Middle Mounting Point)	"G" (Mounting Point to Mounting Point)	"H" (Mounting Point to Mounting Point Intermediate Fixtures)
Order Length	Order length + 3/16" (W2W, W2N, N2W, N2N) Order length + 1 1/8" (P2P) Order length + 5/8" (W2P, P2W, N2P, P2N)	Order Length + 3/8"	Order length + 13/16"	13/16"	Fixture length - 1 1/2"	1 1/16"	Fixture length - 1 1/16"

**TG Trim Run**

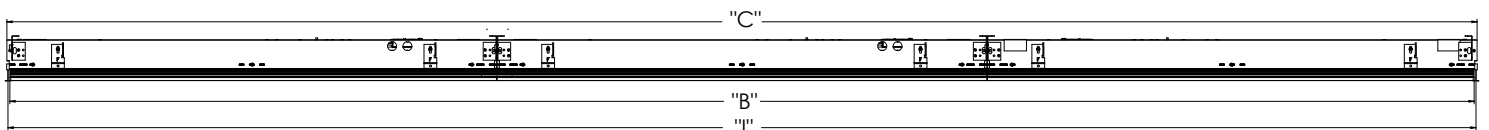

Grid Run Configurations			
"A" (Illuminated Lenth)	"B" (Trim Length)	"C" (Housing Lenth)	"I" (Grid Center to Center)
Order Length - 13/16"	Ordered Length - 5/8"	Order length - 1/32"	Order length + 13/16"

**MOUNTING (continued)**

**Ceiling Cut Out Dimensions**

		2-Foot	3-Foot	4-Foot	5-Foot	6-Foot	7-Foot	8-Foot
TG (BASED ON GRID CENTERLINE TO WALL SPACING)	GRID CL LENGTH(IN)	24	36	48	60	72	84	96
	GRID CL WIDTH(IN)	4.75-5.2	4.75-5.2	4.75-5.2	4.75-5.2	4.75-5.2	4.75-5.2	4.75-5.2
FL	LENGTH(IN) - W2W, W2N, N2W, N2N	24.18	36.18	48.18	60.18	72.18	84.18	96.18
	LENGTH(IN) - P2P	24.375	36.375	48.375	60.375	72.375	84.375	96.375
	LENGTH(IN) - W2P, P2W, N2P, P2N	24.25	36.25	48.25	60.25	72.25	84.25	96.25
	WIDTH(IN)	4.93-5.38	4.93-5.38	4.93-5.38	4.93-5.38	4.93-5.38	4.93-5.38	4.93-5.38

CEILING OPENING DIMENSIONS FOR INSTALLATION, +0.13"/-0.00"

**FIXTURE DIMENSIONS AND WEIGHTS**

			2-Foot	3-Foot	4-Foot	5-Foot	6-Foot	7-Foot	8-Foot
Individual	GRID CL (IN)		24	36	48	60	72	84	96
	OVERALL LENGTH (IN)		23.375	35.375	47.375	59.375	71.375	83.375	95.375
	HOUSING LENGTH (IN)		23.969	35.969	47.969	59.969	71.969	83.969	95.969
	APERTURE (IN)		23.165	35.165	47.165	59.165	71.165	83.165	95.165
TG Left or Right	GRID CL(IN)		24	36	48	60	72	84	96
	PRODUCT LENGTH(IN)		23.688	35.688	47.688	59.688	71.688	83.688	95.688
	HOUSING LENGTH(IN)		23.969	35.969	47.969	59.969	71.969	83.969	95.969
	APERTURE(IN)		23.567	35.567	47.567	59.567	71.567	83.567	95.567
Intermediate	GRID CL(IN)		24	36	48	60	72	84	96
	PRODUCT LENGTH(IN)		24	36	48	60	72	84	96
	HOUSING LENGTH(IN)		23.969	35.969	47.969	59.969	71.969	83.969	95.969
	APERTURE(IN)		24	36	48	60	72	84	96

			2-Foot	3-Foot	4-Foot	5-Foot	6-Foot	7-Foot	8-Foot
Individual	APERTURE(IN)		24	36	48	60	72	84	96
	PRODUCT LENGTH(IN) - W2W, W2N, N2W, N2N		24.180	36.180	48.180	60.180	72.180	84.180	96.180
	PRODUCT LENGTH(IN) - P2P		25.125	37.125	49.125	61.125	73.125	85.125	97.125
	PRODUCT LENGTH(IN) - W2P, P2W, N2P, P2N		24.652	36.652	48.652	60.652	72.652	84.652	96.652
	HOUSING LENGTH(IN)		24.375	36.375	48.375	60.375	72.375	84.375	96.375
FL Left	APERTURE(IN)		24	36	48	60	72	84	96
	PRODUCT LENGTH(IN) - W2x, N2x		24.090	36.090	48.090	60.090	72.090	84.090	96.090
	PRODUCT LENGTH(IN) - P2x		24.562	36.562	48.562	60.562	72.562	84.562	96.562
	HOUSING LENGTH(IN)		24.188	36.188	48.188	60.188	72.188	84.188	96.188
Right	APERTURE(IN)		24	36	48	60	72	84	96
	PRODUCT LENGTH(IN) - x2W, x2N		24.090	36.090	48.090	60.090	72.090	84.090	96.090
	PRODUCT LENGTH(IN) - x2P		24.562	36.562	48.562	60.562	72.562	84.562	96.562
	HOUSING LENGTH(IN)		24.188	36.188	48.188	60.188	72.188	84.188	96.188
Intermediate	APERTURE(IN)		24	36	48	60	72	84	96
	PRODUCT LENGTH(IN)		24	36	48	60	72	84	96
	HOUSING LENGTH(IN)		23.969	35.969	47.969	59.969	71.969	83.969	95.969

\*All values rounded to +/- 1/16"

Approximate Fixture Section Weights		2-Foot	3-Foot	4-Foot	5-Foot	6-Foot	7-Foot	8-Foot
WEIGHT(LBS)		11	14	17	24	27	30	34

**DIRECT SHIELDING & OPTIONS**

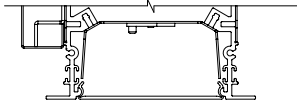

Flush Lens (FLL)  
Continuous Lens (CLL)

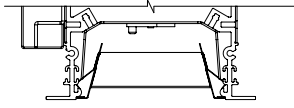

Louver (LVRR)  
Aluminum Louver  
(LVRR) Painted

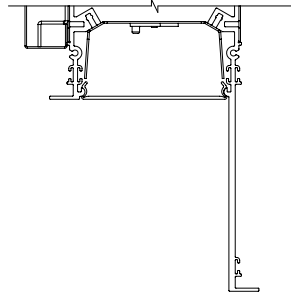

4" Regress with  
FLL or CLL

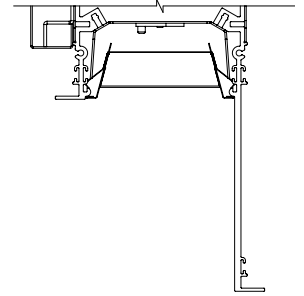

4" Regress with  
LVRR or LVRR

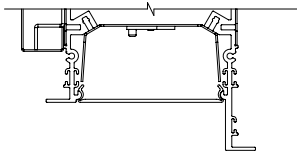

1" Regress with  
FLL or CLL

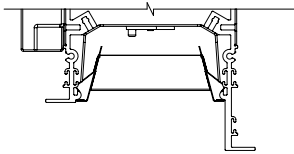

1" Regress with  
LVRR or LVRR

**DIRECT DISTRIBUTION**

Optical Film for DAS and WG distributions with co-extruded lens standard.  
Direction of light for DAS or WG distribution will be in the direction of the notches on the film.

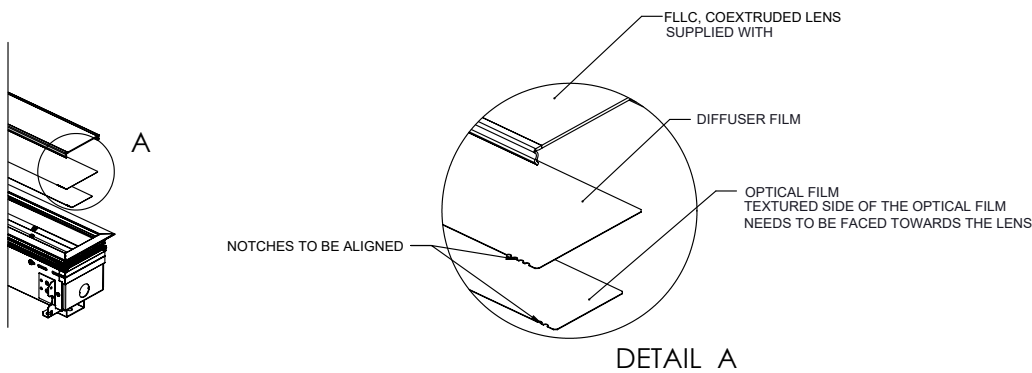

Optical Film	Number of Notches
Diffuser	4
Direct Asymmetric (DAS)	1
Wall Graze (WG)	3

**CONTINUOUS LENS**

40-foot maximum uninterrupted length. From 40-foot 1/8-inch to 106-foot, visible joiner required and supplied with lens rolls. Joiner will match color of trim. Continuous lens and joiners, if required, ship separate from the fixture. Reference installation instructions for further details and steps.

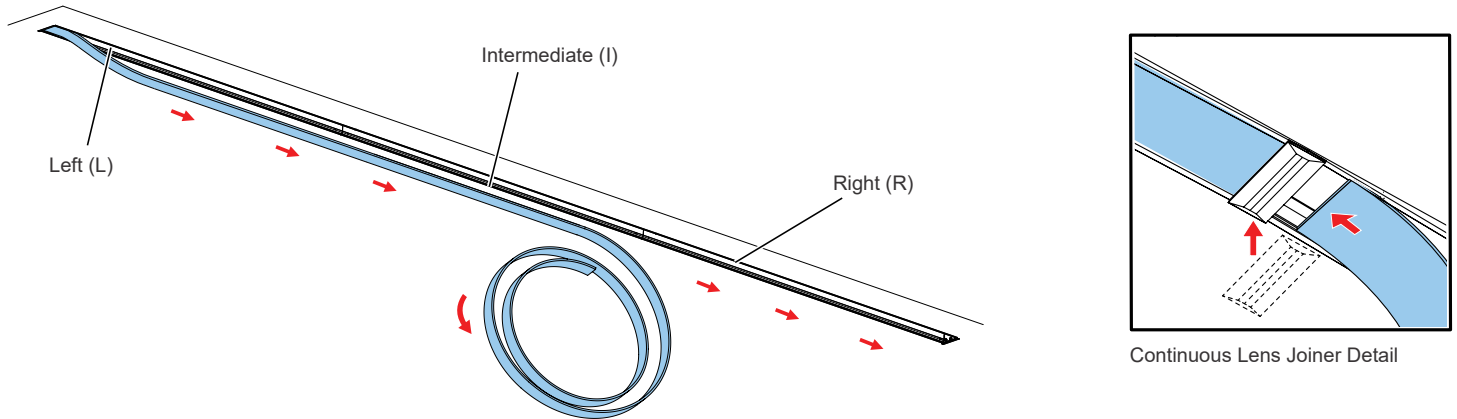

**RUN PATTERNS, CORNERS, & JUNCTIONS**

Patterns can be configured in 1' increments with illuminated L (corner), X, Y, & T connectors. Standard corner has 2' leg segments. Standard L (corner) connector angles are available in 40-179 degrees in 1 degree increments. Standard T & Y connector angles are available in 40-179 degrees in 1 degree increments. Standard X connector angle available in 40-90 degrees in 1 degree increments.

See separate pattern spec sheet for more details.

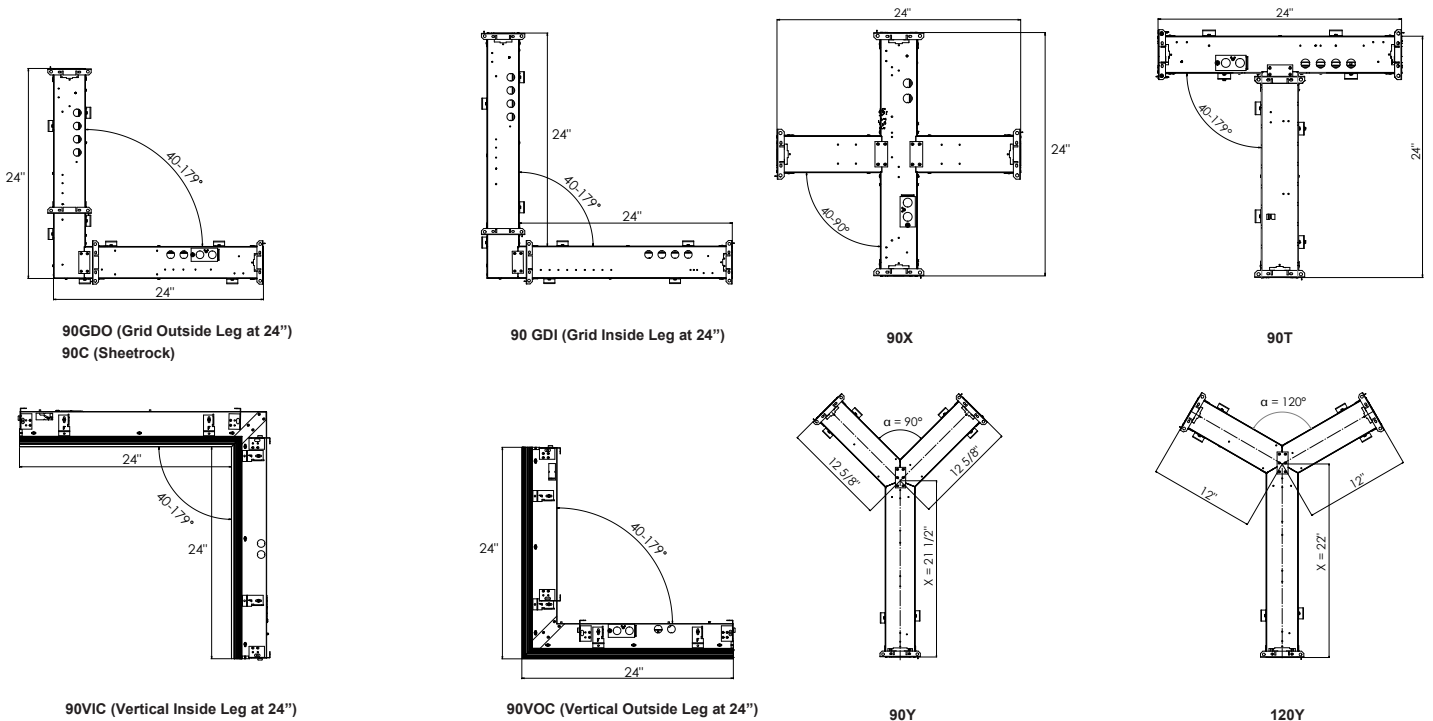

**NOTE:** For Y intersections, dimension X varies depending on the angle  $\alpha$ . Angle  $\alpha$  can be in a range of 40-179°.

**ENDPLATE DETAIL**

**FL Trim Run**

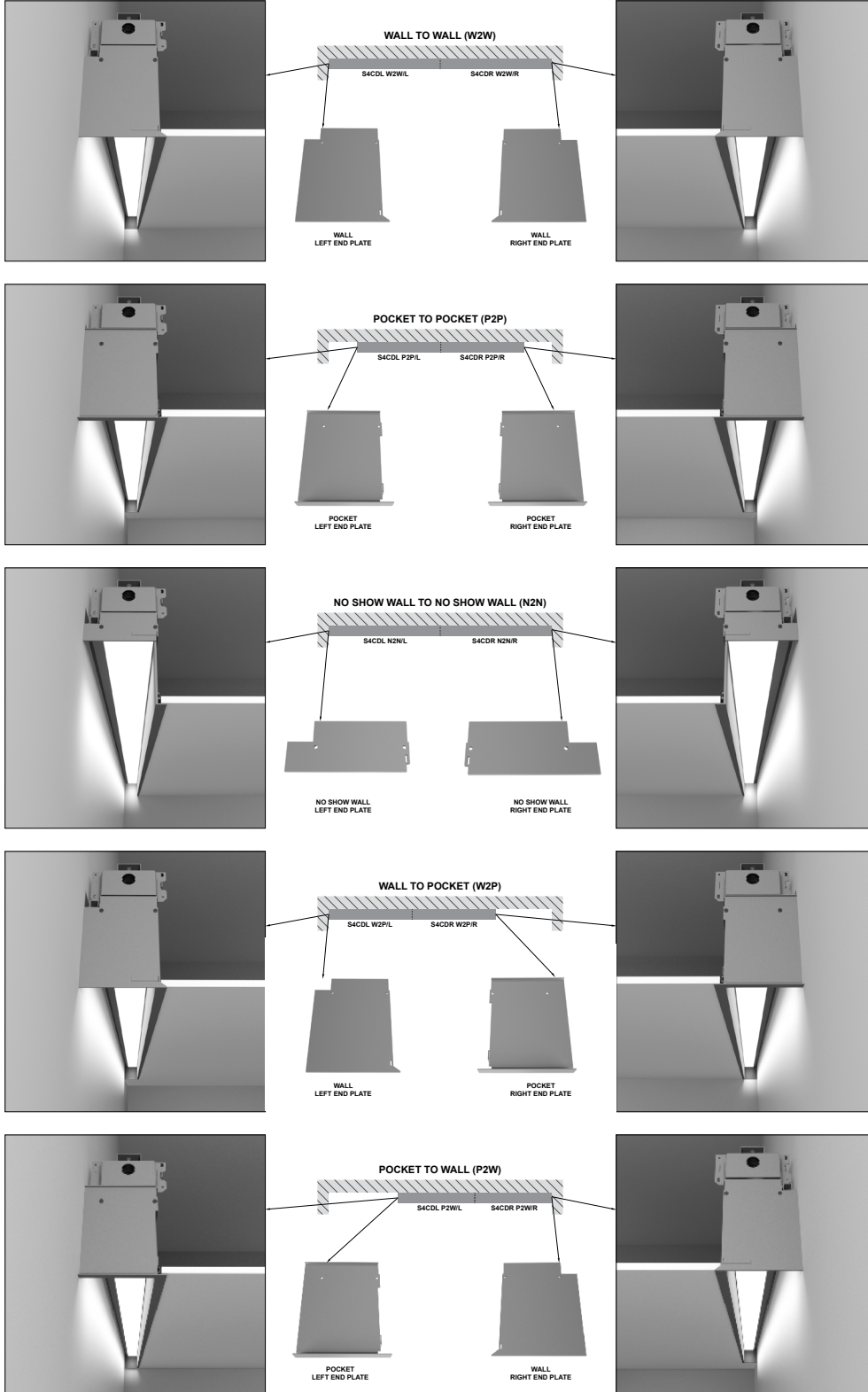

**ENDPLATE DETAIL (continued)**

**FL Trim Run**

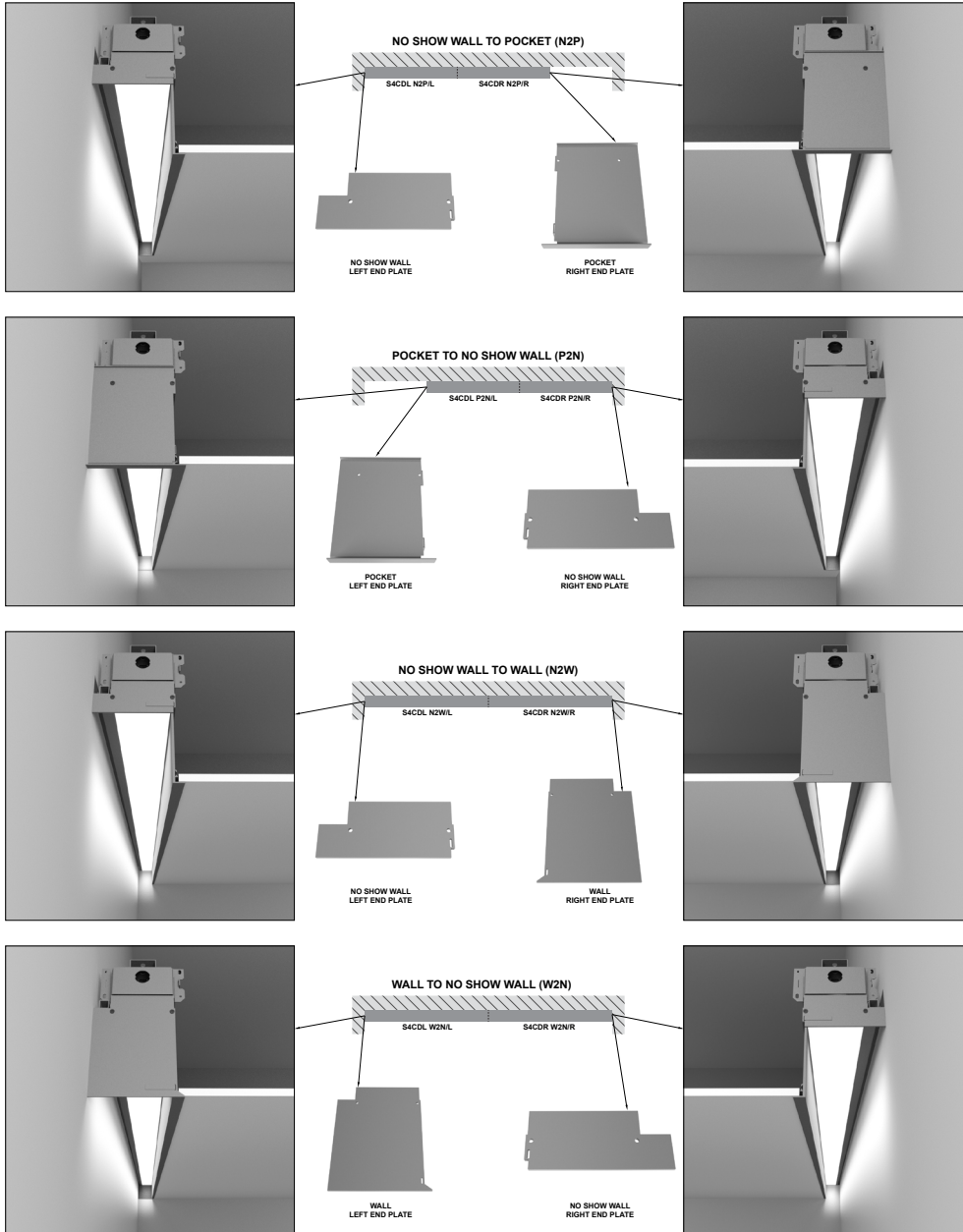

**ENDPLATE DETAIL (continued)**

**TG Trim Run**

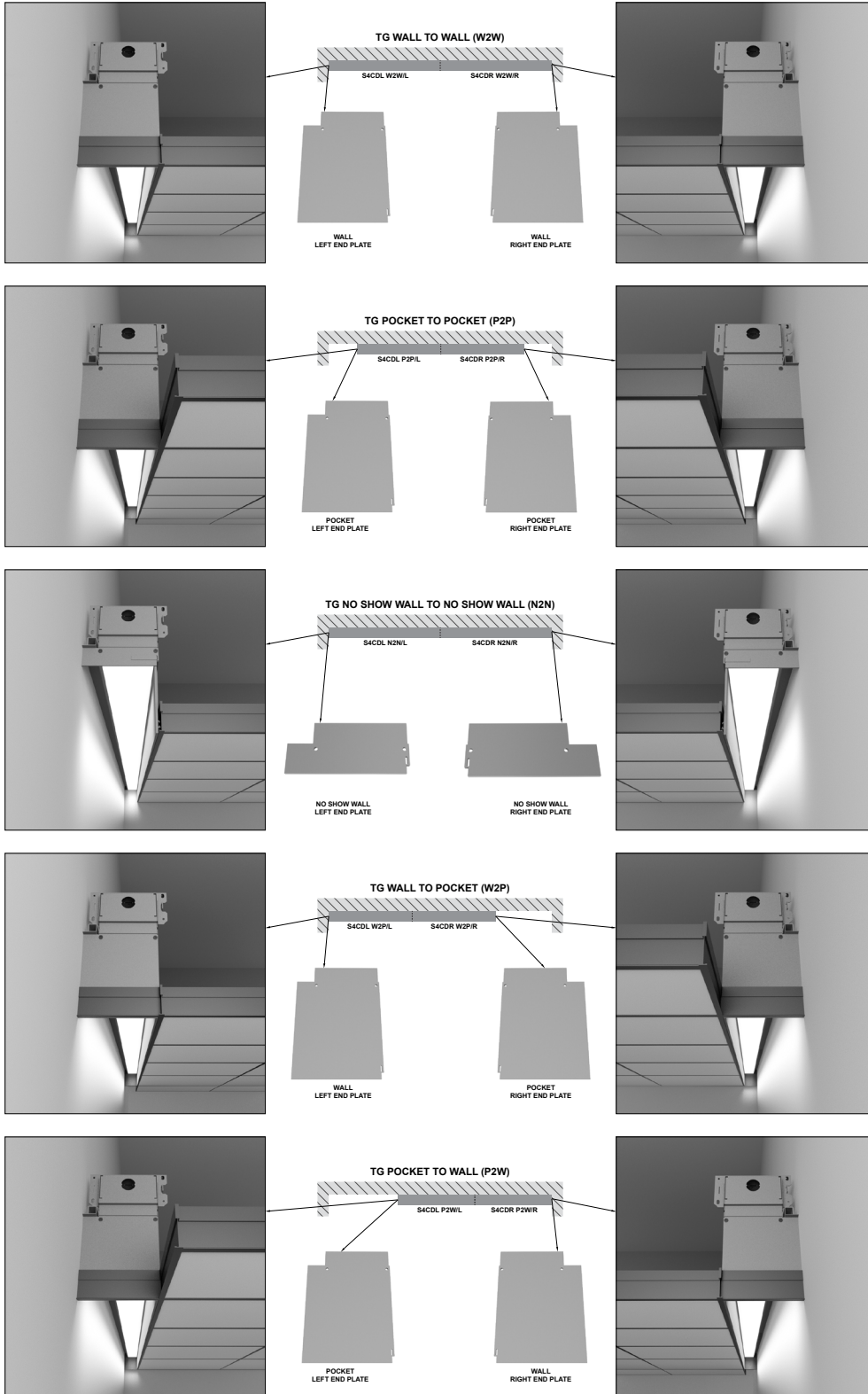

**ENDPLATE DETAIL (continued)**

**TG Trim Run**

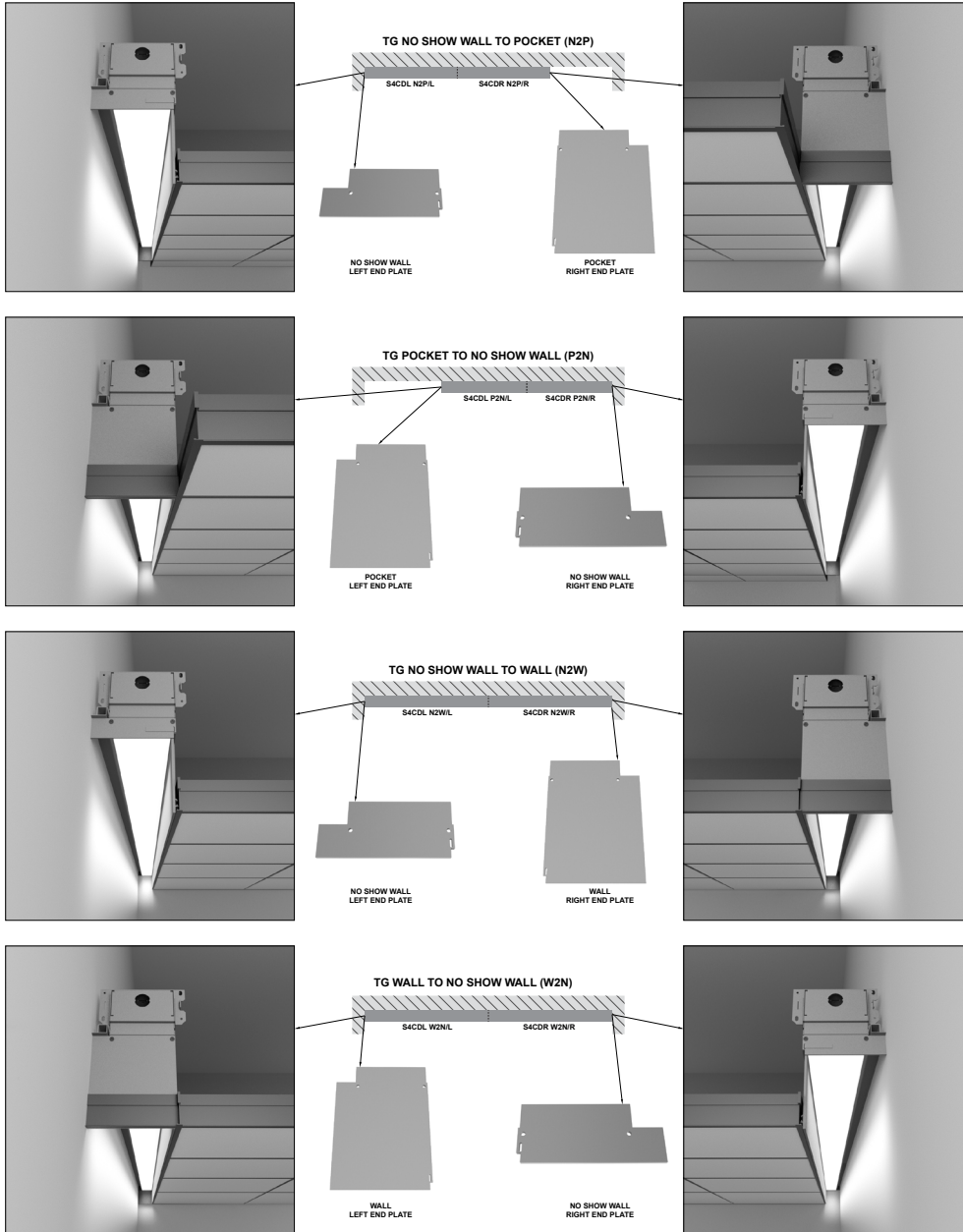

**INTELLIGENT LUMINAIRE GUIDE**

Choose nomenclature from these columns

<b>Driver Configuration (MVOLT)</b>	<b>Minimum Dimming Level</b>	+	<b>Control Input</b>	=	<b>Driver</b>	<b>Dimming Range</b>	<b>Notes</b>
	DARK		NLT		eldoLED DUAL drive DT8 compatible		

Choose nomenclature from these columns

<b>Control / Sensor Configurations</b>	<b>Control Output</b>	+	<b>Sensor</b>	=	<b>Sensor</b>	<b>Notes</b>
	NLT		<blank>		None	
	NLT		ADC		NES ADCX	
	NLT		PDT		NES PDT 7	
	NLT		APIR		NES 7 ADCX	
	NLT		APDT		NES PDT 7 ADCX	
						None
						Automatic dimming control integral photocell.
						360° Dual technology integral occupancy sensor.
						360° PIR integral occupancy sensor with automatic dimming control photocell.
						360° Dual technology integral occupancy sensor with automatic dimming control photocell.

**UL924 Sequence of Operation**

The below information applies to all nLight AIR devices an EM option.

- EM devices will remain at their high-end trim and ignore wireless lighting control commands, unless a normal-power-sensed (NPS) broadcast is received at least every 8 seconds.
- Using the CLAIRITY+ mobile app, EM devices must be associated with a group that includes a normal power sensing device to receive NPS broadcasts.
- Only non-emergency rPP20, rLSXR, rSBOR, rSDGR, and nLight AIR luminaires with version 3.4 or later firmware can provide normal power sensing for EM devices. See specification sheets for control devices and luminaires for more information on options that support normal power sensing.

**nLight® Wired Control Accessories**

Order as separate catalog number

Wall Switches	Model Number
On/Off two pole & Raise/Lower CCT	<a href="#">nPODMA 2P DX CCT (color)</a>
On/Off, 4 scene control, dimming, TUWH	<a href="#">nPODMA 4S DX EDUTW (color)</a>
On/Off, 4 scene control, TUWH	<a href="#">nPODMA 4S EDUTW (color)</a>
Graphic touchscreen	<a href="#">nPOD TOUCH (color)</a>

For more information see [nPODMA](#) and [nPOD TOUCH](#) spec sheets.

**ADDITIONAL OPTIONS**

**Field Adjustable (+0/-12") Section (ADJS)**

Shipped as a 4, 6, 7, or 8-foot individual or end of run right side fixture.  
Left end of fixture is field trimmed to length. Reference page 2 ORDERING  
section for option exclusions.

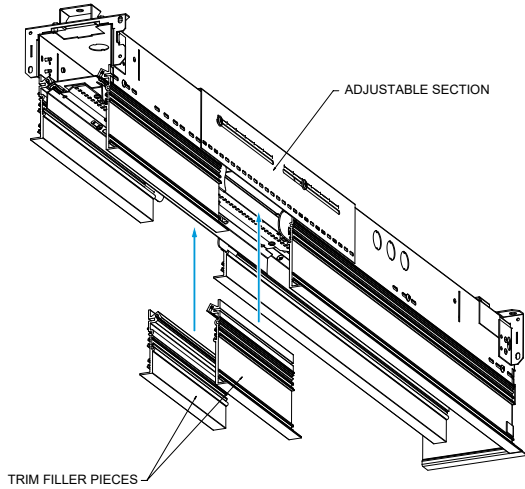

**EMERGENCY OPTIONS**

**Emergency Battery Pack**

The [PS1055LCP](#) battery is integral or remote to the fixture and comes standard with test switch and self-diagnostics. Standard emergency operation as indicated below.

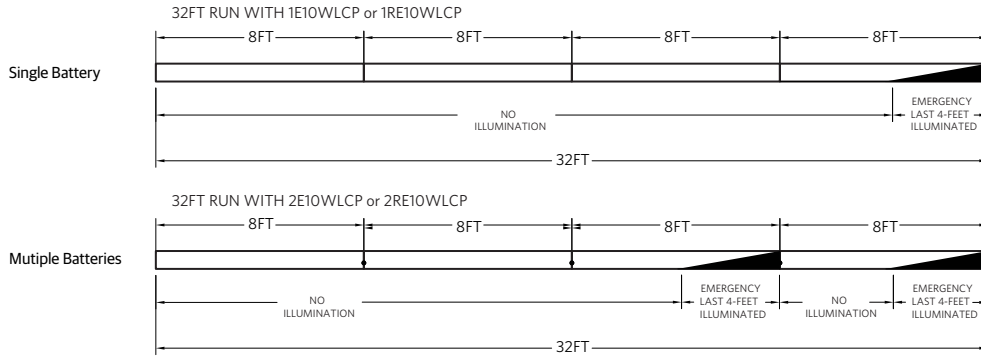

**Emergency Circuits**

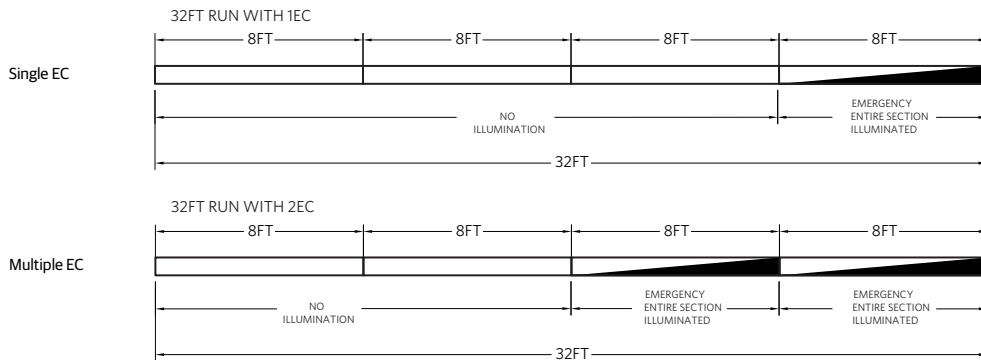

**How to Estimate Delivered Lumens in Emergency Mode (E10WLCP or RE10WLCP)**  
Use the formula below to estimate the delivered lumens in emergency mode

**Delivered Lumens = 1.25 x P x LPW**  
P = 10W for PS1055LCP  
LPW = Lumen per watt rating of the luminaire (Available on page 1 of this spec sheet or appropriate IES file.)  
(Available on page 1 of this spec sheet or appropriate IES file.)

Per tested performance data, maximum mount height of 17-feet calculated to achieve 1 footcandle (10.8 lux) of illumination below emergency battery powered fixture on the path of egress. (Based on fixture tested with 90CRI 27K LED.)  
\*Images used as reference for emergency test switch and dimension.

**Integral Emergency Test Switch**

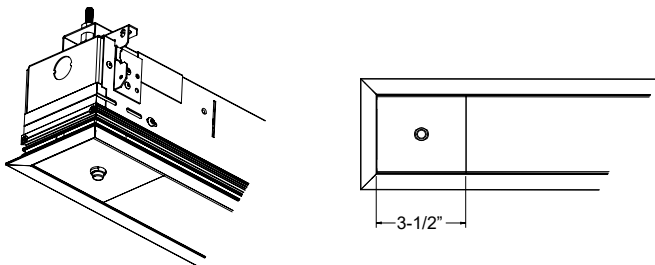

Section Length	Control Input		
	Integral (E10WLCP)	Remote (RE10WLCP)	EC
U2-U2/11.875	n/a	Entire Section Length	Entire Section Length
U3-U3/11.875	n/a	Entire Section Length	Entire Section Length
U4	Entire Section Length	Entire Section Length	Entire Section Length
U4/0.125-U4-11.875	n/a	Last 2-feet of Section Length	Entire Section Length
U5-U5/11.875	Last 3-feet of Section Length	Last 3-feet of Section Length	Entire Section Length
U6-U6/11.875	Last 3-feet of Section Length	Last 3-feet of Section Length	Entire Section Length
U7-U7/11.875	Last 4-feet of Section Length	Last 4-feet of Section Length	Entire Section Length
U8	Last 4-feet of Section Length	Last 4-feet of Section Length	Entire Section Length

**EMERGENCY OPTIONS (Continued)**

**Remote Emergency Battery Pack**

10w linear constant power emergency LED driver is remote mounted from the luminaire. The emergency driver switches power from the normal AC driver and operates the fixture for 90 minutes in the emergency mode from the unit's battery supply. Consists of (1) emergency LED driver within (1) remote mounting enclosure, flexible conduit, test switch, indicator light, cover plate and junction box supplied.

Maximum remote mounting distance from test switch to fixture not to exceed 25-feet.

The maximum emergency remote distance recommended by the manufacturer is 25-feet with 18 AWG wires.

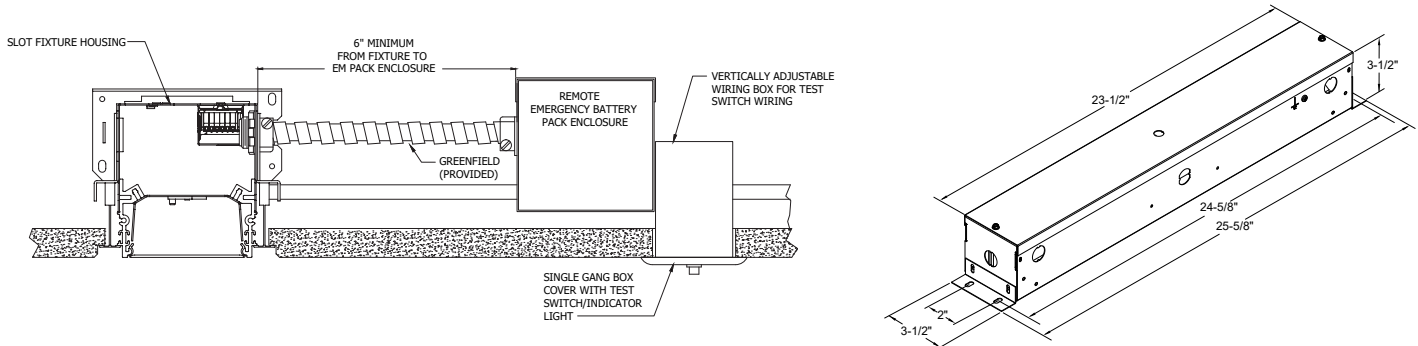

\*Images used as reference for remote emergency components/box connection and dimension.

**Remote GTD Mounting Option**

Emergency generator transfer device is remote mounted from the luminaire. The generator transfer device senses the loss of normal AC power and switches the LED driver input power connection to an unswitched, generator (or central inverter) supplied lighting circuit bypassing the fixture wall switch. Consists of (1) emergency generator transfer device within (1) remote mounting enclosure with 6-foot long flexible conduit.

Maximum remote mounting distance is 6 feet from fixture.

\*Images used as reference for remote GTD box connection and dimension.

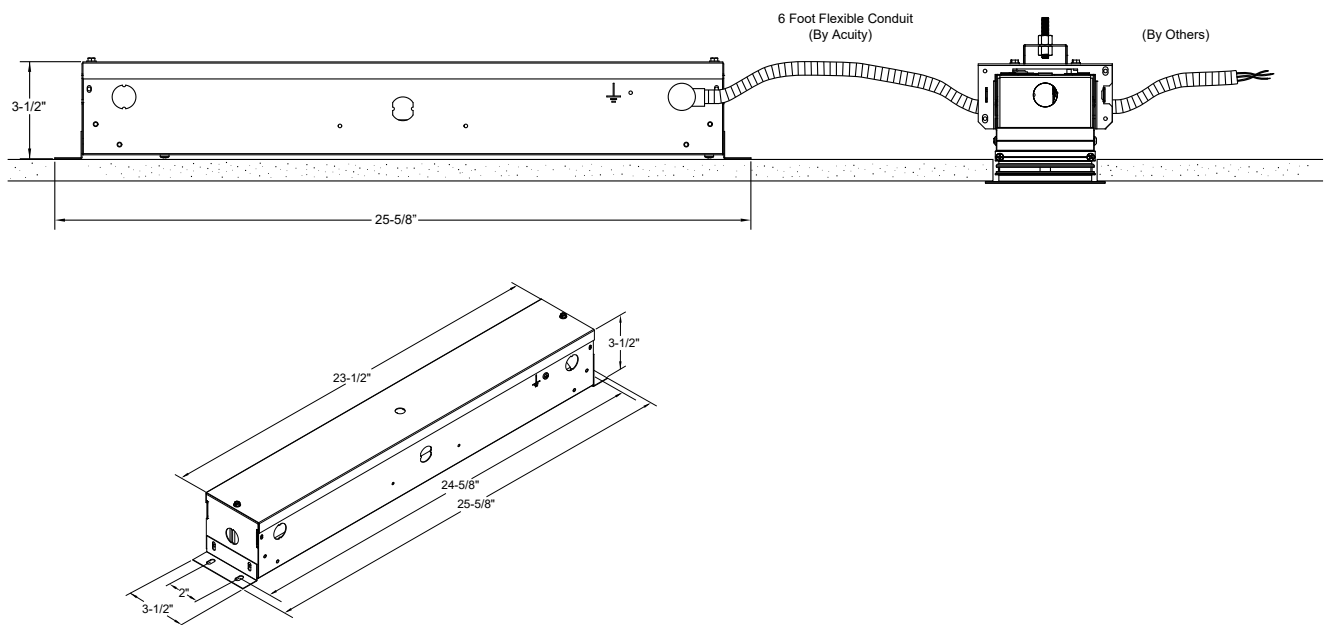

## SPECIFICATIONS

### Housing

Nominal 4" x 2', 3', 4', 5', 6', 7', 8' and continuous rows in 1/8" increments starting at 2', as standard. Upper housing fabricated from cold-rolled steel with extruded aluminum ceiling trim.

### Finish

Standard colors for fixture trims are polyester powder coated white, anti-microbial white, black, or silver with satin sheen. Consult factory for custom colors or specify RAL colors from Architectural brochure.

### Reflector

Precision-formed steel; high reflectance matte white powder coat; 93% reflectivity.

### Optics (Distribution)

Wall Graze (WG) and Direct Asymmetric (DAS) incorporate co-extruded lenses and films.

### Lenses/Shielding

Extruded acrylic lens, (CLL, FLL). Aluminum louver with either a powder coat finish to match housing color (LVRR) or aluminum finish (LVRRRA).

### Mounting

Sheetrock: Recessed ceiling only to accommodate sheetrock, 1/2" minimum to 1-1/2" maximum depth for FL trim option.

Grid: To accommodate 9/16" Flat Tee with Lay-In Tile, 9/16" Flat Tee with Tegular Tile, 9/16" Slot Tee with Tegular Tile, 15/16" Flat Tee with Lay-In Tile, & 15/16" Flat Tee with Tegular Tile for TG trim option.

### LED Source

Multiple lumen packages available in Rhythm Range (2700K-6500K) in 90CRI. The Acuity Brands circuit boards for the linear LED components use a precise binning algorithm which creates a consistent color temperature from board to board. Color variation of no greater than a 2.5 Step MacAdam (2.55DECM) along the black body locus from board to board.

### Electrical

Long-life LEDs, coupled with high-efficiency drivers, provide superior quantity and quality of illumination for extended service life. 90% LED lumen maintenance at 60,000 hours (L90/60,000).

### Circuits

Single switching option only.

### Dimming Driver

Factory tuned constant current electronic dimming driver is standard. Flicker free dimming available down to <1%. LED drivers perform within the recommended operating areas for flicker as a function of frequency and modulation (%) IEEE Standard 1789-2015 (IEEE Recommended Practices for Modulating Current in High-Brightness LEDs for Mitigating Health Risks to Viewers), in typical operating conditions at representative dimming levels. Electrical specifications at maximum driver load: PF > 0.9 and THD <20%. Meets FCC Title 47 Class A or Class B. All drivers are RoHS compliant.

### Controls System Networking Options

Optional integrated nLight® controls make each fixture addressable - allowing it to digitally communicate with other nLight enabled controls such as dimmers, switches, occupancy sensors, and photocontrols. Wired networking through standard Cat-5 cabling. (cabling "by others")

### Mainstream Dynamic with nTune Technology

This luminaire is enabled with nTune technology, meaning it has the ability to communicate digitally over an nLight network. When wired, using CAT-5 cabling, with other nLight-enabled sensors, power packs, or WallPods, an nLight control zone is created. Once linked to a Gateway, directly or via a Bridge, the zone becomes capable of timeclock control, remote status monitoring, and control via SensorView software.

### Emergency Battery (Optional)

Integral emergency battery (E10WLCP) for 90 minutes of operation. Emergency battery pack, 10W, Linear Constant Power Certified in CA Title 20 MAEDBS. Integrated test switch and indicator light. Remote emergency battery (RE10WLCP) for 90 minutes of operation. Emergency battery pack, 10W, Linear Constant Power Certified in CA Title 20 MAEDBS. Remote enclosure, flexible conduit, test switch, indicator light, cover plate and junction box supplied. Remote generator transfer device (GTD) works in conjunction with an auxiliary generator or a central inverter system to power fixtures for safe egress lighting.

### Ambient Operating Temperature Range

-20°C (-4° F) to +25°C (+77°F)

### Environment

Suitable for damp location. Indoor use only.

### Certification

CSA certified to meet U.S. and Canadian standards (UL1598 and UL8750). This product is IC rated.

### Fixture Weight

Approximately 4.0 lbs per foot, less packaging.

### Government Procurement

BAA - Buy America(n) Act: Product qualifies as a domestic end product under the Buy American Act as implemented in the FAR and DFARS. Product also qualifies as manufactured in the United States under DOT Buy America regulations.

BABA - Build America Buy America: Product qualifies as produced in the United States under the definitions of the Build America, Buy America Act.

Please refer to [www.acuitybrands.com/buy-american](http://www.acuitybrands.com/buy-american) for additional information.

### Warranty

5-year limited warranty. This is the only warranty provided and no other statements in this specification sheet create any warranty of any kind. All other express and implied warranties are disclaimed. Complete warranty terms located at: [www.acuitybrands.com/support/warranty/terms-and-conditions](http://www.acuitybrands.com/support/warranty/terms-and-conditions)

**Notes:** Actual performance may differ as a result of end-user environment and application.

All values are design or typical values, measured under laboratory conditions at 25°C.

Specifications subject to change without notice