

PRODUCT SPECIFICATIONS

LED Light Engine Fixture to fixture color consistency within a 2-step MacAdam ellipse • 2700K, 3000K, 3500K, or 4000K color temperatures are available with 80 CRI minimum • 2700K and 3000K also available with 90 CRI minimum.

Modular Optics 45° cutoff to source and source image • Available with field interchangeable optics in 15°, 24°, 35° and 45° distributions • Additional distributions of 20°, 30°, 40°, 50°, 55°, 60° and 60° x 20° FWHM can be achieved with the use of the diffusing films and spot primary optic.

Adjustability Patented Acu-Aim™ precision geared hot-aiming achieves 365° rotation, 40° tilt with any ceiling thickness from ½" to 1" • Acu-Aim™ translates light engine forward as it is aimed off nadir, ensuring maximum light and low brightness • Black aiming mechanism preserves dark aperture.

Trims Style Self Flanged and Flangeless styles are available • Flangeless is compatible with gypsum or solid ceiling materials such as wood, stone, or tile.

LED Driver Choice of two drivers to accommodate voltages from 120-277 volts AC at 50/60Hz • Dims as low as 1% with most incandescent and electronic low voltage dimmers or 0-10V dimmers • For a list of compatible dimmers, refer to [ACULUX LED2-DIM](#) • Power Factor > 0.9 • Field replaceable from above or below ceiling.

Life Rated for 50,000 hrs at 70% lumen maintenance.

Codes/Labels UL and cUL listed for damp locations • Wet location listed with WET option • ICAT new construction fixture meets energy code Air Leakage requirements per ASTM E283 • ENERGY STAR® certified with select trims and housings • Can be used to comply with Title 24, Part 6 with select trims and housings • ICAT new construction luminaire is Chicago Plenum (CCEA) approved standard • ICAT housings are rated for direct contact with insulation, including spray foam insulation with R-Value of 3.7 per inch or less • Union made.

New Construction Mounting Features patented (US Patent 8,038,113) Pro-VIT™ bar hanger system, permitting quick placement of housing with 24" on-center joists or suspended ceilings • ICAT new construction luminaire also features vertically adjustable mounting brackets (butterfly brackets) • Centerline indicators on plaster frame and patented (US Patent 8,277,090) Tru-Line™ Platform featuring +/- ½" translation aids fixture alignment after installation, prior to drywall.

Wiring ICAT housing includes (2) ½" knockouts in access plate, and is compatible with rigid conduit and flexible supply • Non-IC housings include (2) ½" knockouts with pry-out slots in junction box and are compatible with flexible electrical supply only • All housings supplied with quick connect electrical connectors.

Ceiling Thickness ½" - 1 ½" ceiling • Vertical aiming in ceiling 1" to 1 ½" is reduced from 40° to 25°.

**2" LED UNIVERSAL RECESSED
 ADJUSTABLE/DOWNLIGHT/WALL WASH
 800/1200/1500 LUMEN
 ROUND ADJUSTABLE BEVEL
 NEW CONSTRUCTION
 AX2 A with 2ABV Trim**

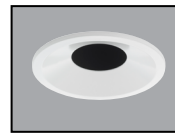

Self-Flanged

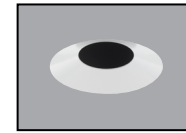

Flangeless



AX2 A ICAT

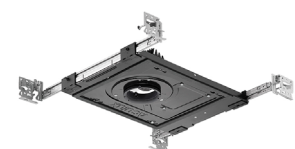

AX2 A

Buy American Act This product is assembled in the USA and meets the Buy America(n) government procurement requirements under FAR, DFARS and DOT regulations. Please refer to www.acuitybrands.com/buy-american for additional information.

Warranty 5-year limited warranty. This is the only warranty provided and no other statements in this specification sheet create any warranty of any kind. All other express and implied warranties are disclaimed. Complete warranty terms located at www.acuitybrands.com/support/warranty/terms-and-conditions

NOTE: Actual performance may differ as a result of end-user environment and application. All values are design or typical values, measured under laboratory conditions at 25°C. Specifications subject to change without notice.

ORDERING INFORMATION

Example: AX2 A G2 08LM 30K 80CRI 24D FPC 120 2ABV BD WHSF

HOUSING OPTIONS

Series / Housing Style	Lumens	CCT	CRI	Beam	Driver	Voltage ²	Options
AX2 A G2 New Construction Universal ADJ/DL/WW	08LM 800 Lumens	27K 2700K	80CRI	15D 15° beam	FPC Phase cut dimming, 1% dim	120 MVOLT (120-277)	CP ICAT IC, Air-Tight, Chicago Plenum NLIGHT ³ nLight dimming pack controls (Must mount remotely)
	12LM 1200 Lumens	30K 3000K	90CRI ¹	24D 24° beam	ZT 0-10V Dimming, 1% dim		
	15LM 1500 Lumens	35K 3500K		35D 35° beam			
		40K 4000K		45D 45° beam			

TRIM OPTIONS

Trim Style	Reflector Finish	Flange Style/Finish	Environment	Ceiling Installation
2ABV Adjustable Bevel	BD Black Diffuse	Self-Flanged WHSF White painted flange BLSF Black painted flange Flangeless⁴ WHFM Flangeless, White trim BLFM Flangeless, Black trim	WET Wet location	Self-Flanged & Flangeless Wood/Stone/Tile ---- Ceiling < .75" CTA2/120 Ceiling 0.75" - 1.20" CTA2/150 Ceiling 1.20" - 1.5" Flangeless Gypsum FMA2/075 Ceiling < .75" FMA2/120 Ceiling 0.75" - 1.20" FMA2/150 Ceiling 1.20" - 1.50"

NOTES

Ordering Notes	
1. 90CRI available on 27K and 30K only	3. nLight compatible with ZT only
2. MVOLT standard on ZT. 120 standard on FPC	4. Flangeless trims in drywall ceilings must specify ceiling installation (FMA2)

2" LED UNIVERSAL RECESSED ADJUSTABLE/DOWNLIGHT/WALL WASH 800/1200/1500 LUMEN ROUND ADJUSTABLE BEVEL NEW CONSTRUCTION AX2 A with 2ABV Trim

TRIM SELECTION

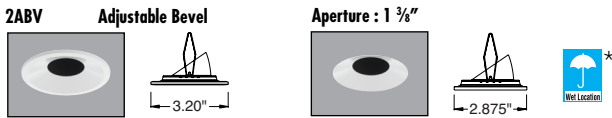

	CCT/CRI:	80CRI 27K, 30K, 35K, 40K 90CRI 27K, 30K
	Optic:	15D, 24D, 35D, 45D
	Trim Finish:	BD BLFM/BSLF, BD WHFM/WHFS

	Construction:	ICAT
	CCT/CRI:	90CRI 27K, 30K
	Optic:	15D, 24D, 35D, 45D
	Trim Finish:	BD BLFM/BSLF, BD WHFM/WHFS

DIMENSIONS

NEW CONSTRUCTION

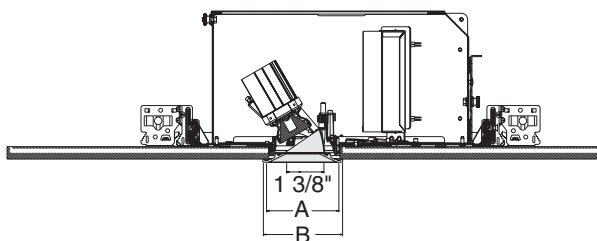
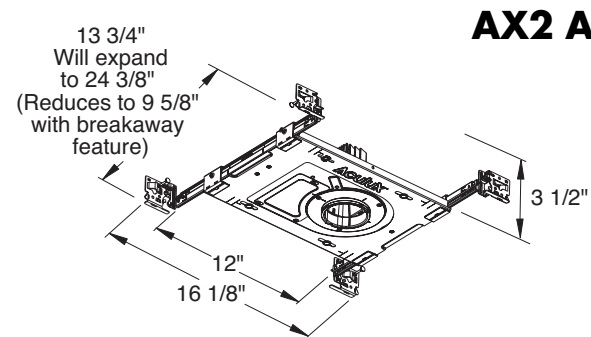
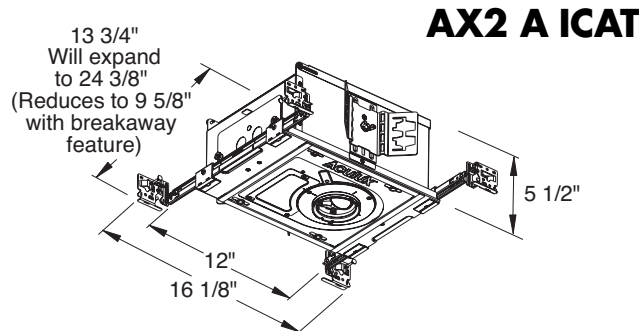

Trim Style	Cutout Size (A)	Trim O.D. (B)
Self Flanged Trims	2-7/8"	3.20"
Flangeless Trims (Solid Ceiling)	2-7/8"	2.875"
Flangeless Trims (Drywall Ceiling)	3"	2.875"

Note: An accurate hole saw is recommended for best results

ACCESSORIES

Cat. #	Description
2AXG2OPT/15D	15° Spot Optic
2AXG2OPT/24D	24° Narrow Flood Optic
2AXG2OPT/35D	35° Flood Optic
2AXG2OPT/45D	45° Wide Flood Optic
AF2/10	10° Film (Use with 15D Optic)
AF2/20	20° Film (Use with 15D Optic)
AF2/30	30° Film (Use with 15D optic)
AF2/40	40° Film (Use with 15D Optic)
AF2/50	50° Film (Use with 15D Optic)
AF2/60	60° Film (Use with 15D optic)
AF2/90x1	90°x1° Film (Use with 15D Optic)
HB1	(2) Real Nail 3 Bar Hangers
HB26	(2) 26" C-Channel Bar Hangers
HB50	(2) 50" C-Channel Bar Hangers
LB27	(2) 27" Linear Bar Hangers
IIS 35 HE	Up to 35W Remote Mount Micro Inverter (AX2SQ 2A G2 15LM and AX2SQ 3A G2 12LM Excluded)

To order, specify catalog number.

DIFFUSING FILMS

To achieve the desired beam angle (FWHM), specify the following primary LED optic on the luminaire and order the diffusing film accessory from the table below

Desired FWHM	Primary Optic	Film	Desired FWHM	Primary Optic	Film
15°	15D	-	45°	45D	-
20°	15D	AF2/10	50°	15D	AF2/40
24°	24D	-	55°	15D	AF2/50
30°	15D	AF2/20	60°	15D	AF2/60
35°	35D	-	60°x20°	15D	AF2/90x1
40°	15D	AF2/30			

ELECTRICAL DATA

Lumen Package	08LM			12LM			15LM		
	Driver Option	FPC	ZT	FPC	ZT	FPC	ZT	FPC	ZT
Voltage	120	120	277	120	120	277	120	120	277
Input Power	10.0	9.9	10.1	14.7	14.3	14.3	17.3	16.5	16.4
Input Current	0.08	0.08	0.04	0.12	0.12	0.06	0.14	0.14	0.06
Frequency	50/60Hz			50/60Hz			50/60Hz		
Power Factor	0.99	0.99	0.9	0.99	0.99	0.92	0.99	0.99	0.92

2" LED UNIVERSAL RECESSED ADJUSTABLE/DOWNLIGHT/WALL WASH 800/1200/1500 LUMEN ROUND ADJUSTABLE BEVEL NEW CONSTRUCTION AX2 A with 2ABV Trim

PHOTOMETRICS

AX2 A G2 15LM 30K 80CRI 15D FPC 120 2ABV BD

3000K LEDs, input watts: 17.3, delivered lumens: 1322, LM/W = 76, test no. PT07172703, tested in accordance to IESNA LM-79

Beam Spread: 15D

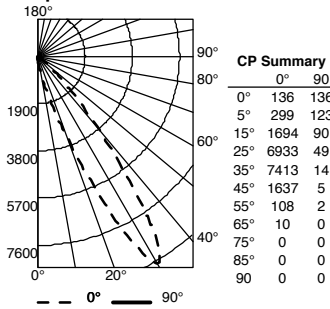

AX2 A G2 15LM 30K 80CRI 24D FPC 120 2ABV BD

3000K LEDs, input watts: 17.3, delivered lumens: 1278, LM/W = 74, test no. PT07172711, tested in accordance to IESNA LM-79

Beam Spread: 24D

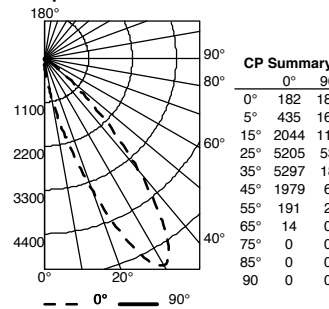

AX2 A G2 15LM 30K 80CRI 35D FPC 120 2ABV BD

3000K LEDs, input watts: 17.3, delivered lumens: 1211, LM/W = 70, test no. PT07172719R, tested in accordance to IESNA LM-79

Beam Spread: 35D

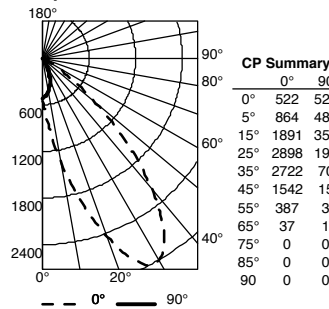

AX2 A G2 15LM 30K 80CRI 45D FPC 120 2ABV BD

3000K LEDs, input watts: 17.3, delivered lumens: 1199, LM/W = 69, test no. PT07172727R, tested in accordance to IESNA LM-79

Beam Spread: 45D

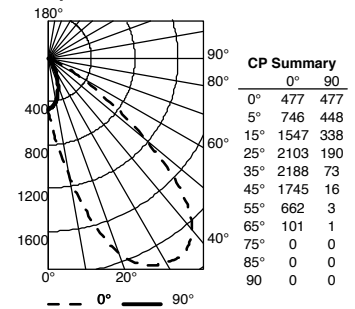

CBCP • Centerbeam candlepower
FC • Footcandles at beam center (aim point)

In vertical aiming applications, aim point (X) is determined by dividing distance from the wall (D) by the tangent of the desired aim angle (A) (0.5774 for 30°, 1.0 for 45°).

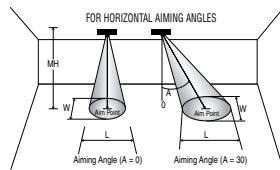

Horizontal Aiming Angles

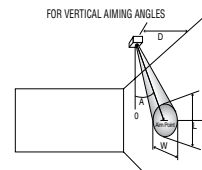

Vertical Aiming Angles

Beam Spread	CBCP	0°			30°			30°				40°					
		MH	FC	L	W	FC	L	W	D	FC	X	L	W	FC	X	L	W
15°	9609	4	601	1.2	1.2	390	1.6	1.4	2	300	3.5	2.6	1.2	638	2.4	1.5	0.9
		6	267	1.8	1.8	173	2.4	2.1	3	133	5.2	3.9	1.8	284	3.6	2.3	1.4
		8	150	2.4	2.4	98	3.2	2.8	4	75	6.9	5.2	2.4	159	4.8	3.0	1.9
		10	96	3.0	3.0	62	4.0	3.5	5	48	8.7	6.5	3.0	102	6.0	3.8	2.3
		12	67	3.6	3.6	43	4.8	4.2	6	33	10.4	7.7	3.6	71	7.2	4.5	2.8
24°	5987	4	374	1.7	1.7	243	2.3	2.0	2	187	3.5	3.9	1.7	398	2.4	2.2	1.3
		6	166	2.5	2.5	108	3.4	2.9	3	83	5.2	5.9	2.5	177	3.6	3.3	2.0
		8	94	3.4	3.4	61	4.6	3.9	4	47	6.9	7.8	3.4	99	4.8	4.4	2.6
		10	60	4.2	4.2	39	5.7	4.9	5	30	8.7	9.8	4.2	64	6.0	5.5	3.3
		12	42	5.1	5.1	27	6.9	5.9	6	21	10.4	11.7	5.1	44	7.2	6.6	4.0
35°	3004	4	188	2.4	2.4	122	3.3	2.8	2	94	3.5	6.7	2.4	199	2.4	3.4	1.9
		6	83	3.6	3.6	54	5.0	4.2	3	42	5.2	10.1	3.6	89	3.6	5.1	2.8
		8	47	4.9	4.9	30	6.7	5.6	4	23	6.9	13.4	4.9	50	4.8	6.8	3.8
		10	30	6.1	6.1	20	8.4	7.0	5	15	8.7	16.8	6.1	32	6.0	8.5	4.7
		12	21	7.3	7.3	14	10.0	8.4	6	10	10.4	20.2	7.3	22	7.2	10.2	5.7
45°	2183	4	136	3.2	3.2	89	4.5	3.7	2	68	3.5	12.6	3.2	145	2.4	5.1	2.5
		6	61	4.8	4.8	39	6.8	5.6	3	30	5.2	18.9	4.8	64	3.6	7.6	3.8
		8	34	6.4	6.4	22	9.1	7.4	4	17	6.9	25.2	6.4	36	4.8	10.1	5.0
		10	22	8.1	8.1	14	11.4	9.3	5	11	8.7	31.4	8.1	23	6.0	12.7	6.3
		12	15	9.7	9.7	10	13.6	11.2	6	8	10.4	37.7	9.7	16	7.2	15.2	7.5

LUMEN OUTPUT MULTIPLIERS

Color Temperature	CRI	Multiplier
2700K	80	0.95
3000K	80	1.00
3500K	80	1.05
4000K	80	1.10

Color Temperature	CRI	Multiplier
2700K	90	0.83
3000K	90	0.87

Lumen Package	Multiplier
800	0.58
1200	0.86
1500	1.00

2" LED UNIVERSAL RECESSED ADJUSTABLE/DOWNLIGHT/WALL WASH 800/1200/1500 LUMEN ROUND ADJUSTABLE BEVEL NEW CONSTRUCTION AX2 A with 2ABV Trim and WET Option

PHOTOMETRICS

AX2 A G2 15LM 30K 80CRI 15D FPC 120 2ABV BD WET

3000K LEDs, input watts: 17.3,
delivered lumens: 1162, LM/W = 67,
test no. PT07172707,
tested in accordance to IESNA LM-79

Beam Spread: 15D

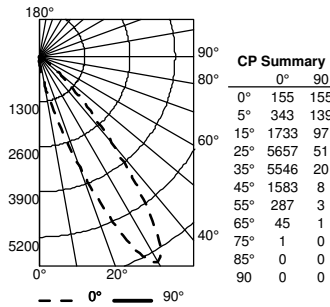

AX2 A G2 15LM 30K 80CRI 24D FPC 120 2ABV BD WET

3000K LEDs, input watts: 17.3,
delivered lumens: 1121, LM/W = 65,
test no. PT07172715,
tested in accordance to IESNA LM-79

Beam Spread: 24D

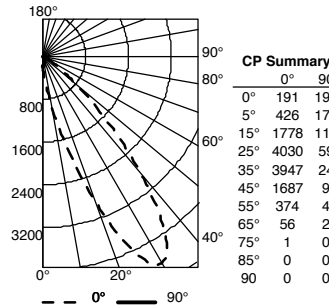

AX2 A G2 15LM 30K 80CRI 35D FPC 120 2ABV BD WET

3000K LEDs, input watts: 17.3,
delivered lumens: 1049, LM/W = 61,
test no. PT07172723R,
tested in accordance to IESNA LM-79

Beam Spread: 35D

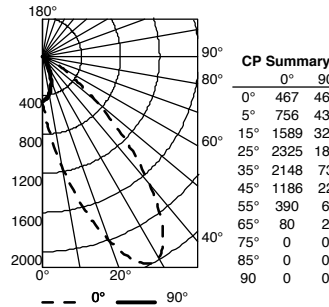

AX2 A G2 15LM 30K 80CRI 45D FPC 120 2ABV BD WET

3000K LEDs, input watts: 17.3,
delivered lumens: 1018, LM/W = 59,
test no. PT07172731R,
tested in accordance to IESNA LM-79

Beam Spread: 45D

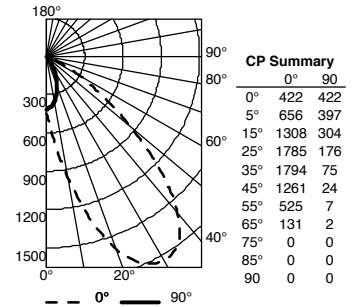

CBCP • Centerbeam candlepower
FC • Footcandles at beam center (aim point)

In vertical aiming applications, aim point (X) is determined by dividing distance from the wall (D) by the tangent of the desired aim angle (A) (0.5774 for 30°, 1.0 for 45°).

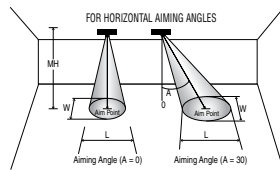

Horizontal Aiming Angles

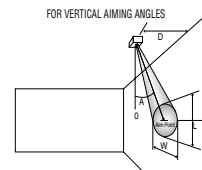

Vertical Aiming Angles

Beam Spread	CBCP	0°			30°			30°				40°					
		MH	FC	L	W	FC	L	W	D	FC	X	L	W	FC	X	L	W
15°	6824	4	426	1.4	1.4	277	1.9	1.6	2	213	3.5	3.1	1.4	453	2.4	1.8	1.1
		6	190	2.1	2.1	123	2.8	2.4	3	95	5.2	4.6	2.1	201	3.6	2.6	1.6
		8	107	2.8	2.8	69	3.7	3.2	4	53	6.9	6.1	2.8	113	4.8	3.5	2.2
		10	68	3.5	3.5	44	4.7	4.0	5	34	8.7	7.6	3.5	72	6.0	4.4	2.7
		12	47	4.2	4.2	31	5.6	4.8	6	24	10.4	9.2	4.2	50	7.2	5.3	3.2
24°	4458	4	279	1.8	1.8	181	2.5	2.1	2	139	3.5	4.3	1.8	296	2.4	2.4	1.4
		6	124	2.7	2.7	80	3.7	3.2	3	62	5.2	6.5	2.7	132	3.6	3.6	2.1
		8	70	3.6	3.6	45	5.0	4.2	4	35	6.9	8.6	3.6	74	4.8	4.8	2.8
		10	45	4.6	4.6	29	6.2	5.3	5	22	8.7	10.8	4.6	47	6.0	6.0	3.5
		12	31	5.5	5.5	20	7.4	6.3	6	15	10.4	13.0	5.5	33	7.2	7.2	4.3
35°	2381	4	149	2.5	2.5	97	3.4	2.9	2	74	3.5	7.0	2.5	158	2.4	3.5	1.9
		6	66	3.7	3.7	43	5.1	4.3	3	33	5.2	10.4	3.7	70	3.6	5.2	2.9
		8	37	5.0	5.0	24	6.8	5.7	4	19	6.9	13.9	5.0	40	4.8	6.9	3.9
		10	24	6.2	6.2	15	8.5	7.1	5	12	8.7	17.4	6.2	25	6.0	8.7	4.8
		12	17	7.4	7.4	11	10.2	8.6	6	8	10.4	20.9	7.4	18	7.2	10.4	5.8
45°	1844	4	115	3.2	3.2	75	4.5	3.7	2	58	3.5	12.0	3.2	122	2.4	5.0	2.5
		6	51	4.8	4.8	33	6.7	5.5	3	26	5.2	18.1	4.8	54	3.6	7.4	3.7
		8	29	6.4	6.4	19	8.9	7.3	4	14	6.9	24.1	6.4	31	4.8	9.9	4.9
		10	18	7.9	7.9	12	11.2	9.2	5	9	8.7	30.1	7.9	20	6.0	12.4	6.2
		12	13	9.5	9.5	8	13.4	11.0	6	6	10.4	36.1	9.5	14	7.2	14.9	7.4

LUMEN OUTPUT MULTIPLIERS

Color Temperature	CRI	Multiplier
2700K	80	0.95
3000K	80	1.00
3500K	80	1.05
4000K	80	1.10

Color Temperature	CRI	Multiplier
2700K	90	0.83
3000K	90	0.87

Lumen Package	Multiplier
800	0.58
1200	0.86
1500	1.00