

# ENVIRONMENTALLY FRIENDLY, ENERGY EFFICIENT

- Lumen packages suitable for ceiling heights ranging from 8' to in excess of 100'
- Efficacies up to 124 lm/w
- Superior-quality white LED light output using Chip on Board technology
- Patented Hyperbolic Reflector (U.S. Patent No. 10,670,227 B2)
- **Low UGR:** UGR of zero for fixtures aimed at nadir with a cut-off equal to or less than 60deg per CIE 117-1995 Discomfort Glare in Interior Lighting.

## PRODUCT SPECIFICATIONS

**Atrius™ - Ready Product:** Select models of the L-series product line deliver valuable data and connectivity to the Atrius IoT location based platform services. For more information, please refer to [www.acuitybrands.com/Atrius](http://www.acuitybrands.com/Atrius).

### OPTICS

**Hyperbolic:** Patented hyperbolic shape (U.S. Patent No. 10,670,227 B2) optimized for small, directional LED source, maximizes fixture efficiency while creating the "Silent Ceiling" appearance by reducing lamp image and aperture brightness • Geometry of hyperbolic curve provides unique aperture appearance and smoother light distribution

**Parabolic/Lens:** Computer-optimized parabolic reflector with frosted convex lens regressed into cone provides uniform distribution with no striations

**Wall Wash:** Available in Hyperbolic and Parabolic. Both providing uniform distributions with no striations

### ELECTRICAL

**LED Light Engine:** Compact light source delivers uniform illumination without pixilation, enabling excellent beam control • 2SDCM (5000K within 3SDCM) • 80, 90 & 97 CRI • Replaceable light engine with push in wire connections mounts directly to heat sink and is easily replaceable

**Passive Cooling:** Aluminum heat sink integrated directly with housing provides superior thermal management to ensure the long life of LED

**LED Driver:** Power factor >0.9 • Easily replaceable from above or below the ceiling

**Dimming:** Dimmable via 0-10V protocol standard • Optional drivers available for use with eldoLED, Lutron EcoSystem, 2-wire dimmers, DMX, or DALI • For a list of compatible dimmers, see [LED-DIM](#).

**Life:** Rated for 60,000 hours at 70% lumen maintenance

**Emergency Battery Pack (Optional) output:** Provides a minimum of 600 (BR & BRT20C), or 1000 (HBR) lumens for a minimum duration of 90 minutes • BRT20C option is CEC Title 20 compliant

### GOVERNMENT PROCUREMENT

**BAA - Buy America(n) Act:** Product qualifies as a domestic end product under the Buy American Act as implemented in the FAR and DFARS. Product also qualifies as manufactured in the United States under DOT Buy America regulations.

**BABA - Build America Buy America:** Product qualifies as produced in the United States under the definitions of the Build America, Buy America Act.

Please refer to [www.acuitybrands.com/buy-american](http://www.acuitybrands.com/buy-american) for additional information.

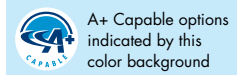

**J7.1.1G4**

**800 TO 9000 LUMEN 6" LED  
NEW CONSTRUCTION/REMODEL**

HYPERBOLIC / PARABOLIC / WALLWASH

## L6 / LRM6 SERIES

Type	Cat. No.
_____	_____
Project: _____	
Notes: _____	

**Warranty:** 5 years when used in accordance with manufacturing guidelines. This is the only warranty provided and no other statements in this specification sheet create any warranty of any kind. All other express and implied warranties are disclaimed.

**Note:** Actual performance may differ as a result of end-user environment and application. Specifications subject to change without notice.

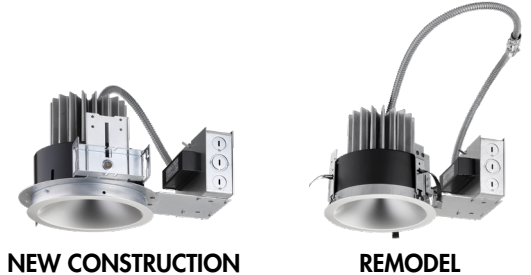

## ORDERING INFORMATION Complete Catalog# Example Includes (Rough-In, option, reflector, accessory) Ordering Example: L6 08LM 35K MVOLT G4 80CRI ZT HW CS PF HBTL

### ROUGH-IN

Series	Light Engine	Color Temperature	Voltage	Generation	CRI	Driver	Rough-In Options
L6	6" L-Series New Construction Downlight	08LM	27K 2700K	120	G4	80CRI	F <sup>3,8</sup> CP <sup>9</sup> BR <sup>3,11</sup>
		13LM	30K 3000K	277			
LRM6	6" L-Series Remodel Rough-in	15LM	35K 3500K	347	MVOLT <sup>1</sup> (120-277)	80CRI 97CRI <sup>2</sup>	BRT20C <sup>3,11</sup> HBR <sup>3,11</sup> NL <sup>8,10</sup> NLER <sup>8,10</sup> NLTAIR <sup>2,3,10,16</sup> NLTAIRER <sup>2,3,10,16</sup> AE2CD <sup>15,16</sup>
		17LM	40K 4000K				
		23LM	50K 5000K				
		28LM					
		33LM					
		40LM					
		45LM					
		50LM					
		55LM					
		60LM					
		65LM					
		70LM					
		75LM					
80LM							
85LM							
90LM							
						EDAB <sup>5</sup>	elidoLED SOLOdrive DALI. Logarithmic dimming to <1%
						EDXB <sup>5,18</sup>	elidoLED POWERdrive DMX/RDM w/ Phoenix Connectors. Dimming to <1%
						EZ10 <sup>18</sup>	elidoLED 0-10V ECOdrive. Linear dimming to 10% min.
						EZ1 <sup>18</sup>	elidoLED 0-10V ECOdrive. Linear dimming to 1% min.
						EZB <sup>18</sup>	elidoLED 0-10V SOLOdrive. Logarithmic dimming to <1%
						FD <sup>4,6</sup>	Forward or Reverse Phase Dimming Driver
						ECOD <sup>7,13,19</sup>	Lutron Ecosystem 2-Wire Dimming Driver
						ZT	0-10V Dimming to 10% min
						GZ1 <sup>4</sup>	0-10V Dimming to 1% min

**REFLECTOR** To order reflector separately, use "L6" prefix before reflector option values. Ex: L6 HW CS PF

Trim Style				Finish				Trim Options		Mounting	
<b>HM</b> <sup>11</sup>	Hyperbolic Medium	<b>P</b>	Parabolic	<b>BD</b>	Black Diffuse	<b>GD</b>	Gold Diffuse	<b>PF</b> <sup>12</sup>	White Flange	<b>Blank</b>	Flanged
<b>HW</b> <sup>11</sup>	Hyperbolic Wide	<b>WPR</b> <sup>17</sup>	Parabolic Wide	<b>BS</b>	Black Specular	<b>GS</b>	Gold Specular	<b>WET</b>	Wet Location		
<b>HWS</b> <sup>11</sup>	Hyperbolic Single Wall Wash	<b>WC</b> <sup>11</sup>	Corner Wall Wash	<b>CD</b>	Clear Diffuse	<b>PTD</b>	Pewter Diffuse				
		<b>WD</b> <sup>11</sup>	Double Wall Wash	<b>CS</b>	Clear Specular	<b>PTS</b>	Pewter Specular				
		<b>WS</b> <sup>11</sup>	Single Wall Wash	<b>CSS</b>	Clear Semi-Specular	<b>WH</b>	White, White Flange				
						<b>WTD</b>	Wheat Diffuse				
						<b>WTS</b>	Wheat Specular				

Accessories <sup>15</sup>			
<b>HB28</b> <sup>14</sup>	28" C-Channel Bar Hangers, Pair	<b>INSA6/05</b> <sup>14</sup>	6" Sloped Ceiling Adapter, 5° Angle
<b>HB52</b> <sup>14</sup>	52" C-Channel Bar Hangers, Pair	<b>INSA6/10</b> <sup>14</sup>	6" Sloped Ceiling Adapter, 10° Angle
<b>HBTL</b> <sup>14</sup>	25" Tru-Lock Grid Ceiling Bar Hanger, Pair	<b>INSA6/15</b> <sup>14</sup>	6" Sloped Ceiling Adapter, 15° Angle
<b>LB27</b> <sup>14</sup>	27" Linear Bar Hangers, Pair	<b>INSA6/20</b> <sup>14</sup>	6" Sloped Ceiling Adapter, 20° Angle
		<b>INSA6/25</b> <sup>14</sup>	6" Sloped Ceiling Adapter, 25° Angle
		<b>INSA6/30</b> <sup>14</sup>	6" Sloped Ceiling Adapter, 30° Angle

**Ordering Notes**

- 1 MVOLT not available for 85LM and up.
- 2 2700K & 3000K only.
- 3 Not available with 347V.
- 4 Not available for 60LM and up.
- 5 Not available for 40LM and 55LM and up.
- 6 120V only.
- 7 Not available for 50LM and up.
- 8 Specify voltage.
- 9 See CP notes in following table for compatibility with other options.
- 10 Only compatible with the following driver options: EZ1, EZB, EZ10, GZ1; ZT (for 60LM - 90LM only).
- 11 Not compatible with WET.
- 12 PF not available with BL or WH finishes. When specifying BL or WH finishes, flange is always painted white.
- 13 Not compatible with BR, BRT20C, or HBR
- 14 Not compatible with LRM6.
- 15 See AE2CD notes in following table for compatibility with other options.
- 16 NLTAIR2, NLTAIRER2, AE2CD not recommended for metal ceiling installations.
- 17 WPR available with CS, CSS, CD, WH finishes only.
- 18 Not available for 85LM and up.
- 19 ECOD with MVOLT only available for 08LM - 17LM.

**CP Notes**

CP with MVOLT only available for 08LM - 17LM.  
BR, BRT20C, HBR, EDXB, NL, NLER, NLTAIR2, NLTAIRER2, AE2CD not compatible with CP.

**AE2CD Notes**

Not available with 347 for LRM6 series.  
Only compatible with EZ1 driver for 55LM and below.  
CP, BR, BRT20C, HBR, NL, NLER, NLTAIR2, NLTAIRER2 not compatible with AE2CD.  
Recommended ceiling height of 30' and under; not intended for use on ceilings greater than 40' or metal ceiling installations.

The Bluetooth® word mark and logos are registered trademarks owned by Bluetooth SIG, Inc. and any use of such marks by Acuity Brands Lighting is under license.

**PRODUCT SPECIFICATIONS** (cont.)

**MECHANICAL**

**New Construction Housing:** Low profile, universal housing design installs in suspended grid, plaster or drywall • Integral heat sink conducts heat away from LED light engine • Driver is accessible from above and below ceiling and can be upgraded to accommodate future technology improvements

**Mounting Frame:** Heavy gauge steel lower housing ring accommodates ceilings up to 2" thick • For thicker ceilings; consult factory

**Mounting Bracket:** New Construction mounting brackets have 3" vertical adjustment and accepts most commercial bar hangers, including our proprietary Tru-Lock bar hangers • Our one-piece Tru-Lock bar hangers have integral T-bar locking screws and alignment notches for locating and locking fixture in the center or 1/4" tile increments

**Junction Box:** Over size 4" x 6" galvanized steel junction box with (6) 1/2" (2) 3/4" knockouts facilitate quick wiring • New Construction junction box rated for four (4) No. 12 AWG 90° C branch circuit conductors (2-in, 2-out)

**Remodel Housing:** Housing installs from below ceiling in applications where above ceiling access is not available • Secured in place by factory installed remodel springs • Remodel springs accommodate ceilings from 1/2" to 1-1/8" thick • Integral heat sink conducts heat away from LED light engine • Driver is accessible from below the ceiling and can be upgraded to accommodate future technology improvements.

**TRIMS:**

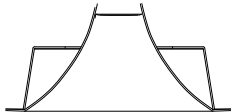

HYPERBOLIC

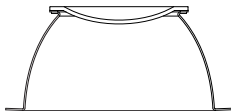

PARABOLIC

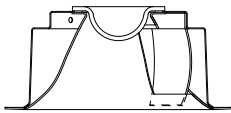

HYPERBOLIC WALLWASH

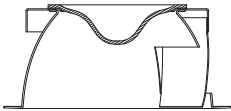

PARABOLIC WALLWASH

APERTURE: 6-1/8" Dia.  
 CEILING CUTOUT: 6-7/8" Dia.  
 OVERLAP TRIM: 7-3/8" Dia.

**NEW CONSTRUCTION**

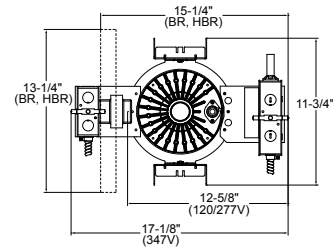
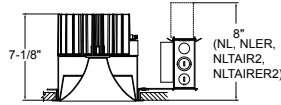

**Atrius Enabled**

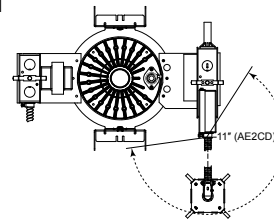
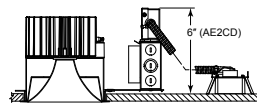

**REMODEL**

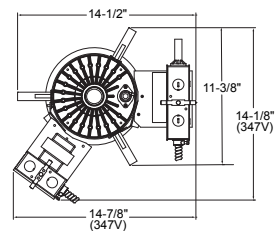

**Atrius Enabled**

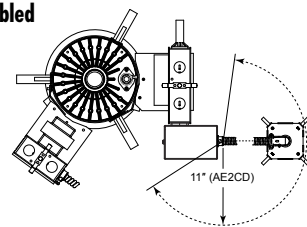
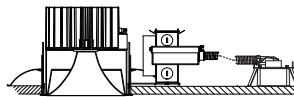

**ENERGY STAR® certified**

	PRODUCT#	FIXTURE CONFIGURATIONS = ENERGY STAR
	(S) (WW)LM (XX)K (V) G4 (YY)CRI (UU) (ZZ) (CC)	Series: S = L6, LRM6 Lumen Package: WW = 08, 13, 15, 17, 23, 28, 33, 40, 45, 55, 65, 75, 80, 85, 90 CCT: XX = 27, 30, 35, 40, 50 Voltage: V = MVOLT, 120, 277 CRI: YY = 80, 90, 97 Trim: UU = FD, EZ1, EZ10, EZB, Z1, GZ1 Trim Type: ZZ = HM, HW, P, WPR Trim Color/Finish: CC = CS, CSS, CD

**LABELS AND LISTINGS**

- Tested to UL1598 and CSA C22.2 250 and listed for feed through and damp locations
- Spacing requirement for 40LM and above: minimum of 4' between fixture centers, 3" overhead clearance, 2' from fixture center to side wall
- RoHS compliant
- EMI complies with FCC 47, Part 15, Class A
- ENERGY STAR® certified, see table for designated products
- I.B.E.W. Union made
- ARRA Compliant 

## PERFORMANCE

LIGHT ENGINE	08LM	13LM	15LM	17LM	23LM	28LM	33LM	40LM	45LM	50LM	55LM	60LM	65LM	70LM	75LM	80LM	85LM	90LM	
<b>120V (50/60HZ)</b>																			
<b>INPUT CURRENT</b>	0.063	0.098	0.115	0.132	0.197	0.238	0.280	0.351	0.345	0.381	0.427	0.439	0.483	0.541	0.573	0.607	0.656	0.710	
<b>INPUT WATTAGE</b>	7.53	11.74	13.66	15.82	23.52	28.46	33.62	42.14	41.41	45.54	51.08	52.51	58.11	64.59	68.84	72.83	78.87	85.03	
<b>THD%</b>	6.42	5.19	4.61	3.86	5.09	5.46	4.43	4.53	6.03	6.03	6.23	6.44	6.54	7.32	7.58	7.75	8.37	8.05	
<b>POWER FACTOR</b>	0.993	0.993	0.992	0.994	0.994	0.995	0.997	0.998	0.996	0.996	0.996	0.996	0.996	0.995	0.995	0.996	0.996	0.996	
<b>277V (50/60HZ)</b>																			
<b>INPUT CURRENT</b>	0.031	0.048	0.056	0.063	0.093	0.108	0.131	0.158	0.161	0.175	0.195	0.202	0.221	0.251	0.265	0.268	0.290	0.310	
<b>INPUT WATTAGE</b>	7.87	11.84	13.81	15.89	23.65	28.19	33.83	41.68	41.74	45.80	51.02	52.35	57.64	64.22	68.40	71.29	77.27	83.16	
<b>THD%</b>	12.00	11.62	11.31	11.34	9.93	9.04	10.48	8.79	9.15	8.07	9.85	11.12	10.97	13.07	12.83	12.96	13.53	12.56	
<b>POWER FACTOR</b>	0.904	0.885	0.887	0.907	0.918	0.943	0.932	0.953	0.934	0.943	0.944	0.933	0.942	0.921	0.931	0.957	0.962	0.965	
<b>HYPERBOLIC REFLECTOR: L6 HW CS (35K 80CRI)</b>																			
<b>DELIVERED LUMENS (L6 HW CS)</b>	842	1,404	1,622	1,847	2,486	2,998	3,489	4,242	4,511	4,936	5,466	5,677	6,215	6,803	7,123	7,556	8,342	8,782	
<b>EFFICACY (LPW)</b>	112	120	119	117	106	105	104	101	109	108	107	108	107	105	103	104	106	103	
<b>PARABOLIC REFLECTOR: L6 P CS (35K 80CRI)</b>																			
<b>DELIVERED LUMENS (L6 P CS)</b>	666	1,111	1,284	1,462	1,968	2,373	2,762	3,358	3,657	4,002	4,431	4,602	5,038	5,515	5,774	6,125	6,762	7,119	
<b>EFFICACY (LPW)</b>	89	95	94	92	84	83	82	80	88	88	87	88	87	85	84	84	86	84	

## OPTICAL DISTRIBUTIONS

HYPERBOLIC BEAM SPREAD		
Trim	08LM - 40LM	45LM-90LM
L6 HM CS	53°	60°
L6 HM CSS	53°	60°
L6 HM CD	65°	65°
L6 HW CS	71°	73°
L6 HW CSS	71°	73°
L6 HW CD	71°	73°

PARABOLIC BEAM SPREAD		
Trim	08LM - 40LM	45LM-90LM
L6 P CS	65°	66°
L6 P CSS	62°	63°
L6 P CD	72°	72°
L6 WPR CS	78°	78°
L6 WPR CSS	78°	78°
L6 WPR CD	78°	78°

## LUMEN MULTIPLIERS

CCT	MULTIPLIER
2700K	0.90
3000K	0.96
3500K	1.00
4000K	1.01
5000K	1.04

CRI	MULTIPLIER
80CRI	1.00
90CRI	0.83
97CRI	0.77

HYPERBOLIC TRIM	MULTIPLIER
L6 HM CS	0.98
L6 HM CSS	0.95
L6 HM CD	0.84
L6 HW CS	1.00
L6 HW CSS	0.97
L6 HW CD	0.89

PARABOLIC TRIM	MULTIPLIER
L6 P CS	1.00
L6 P CSS	0.96
L6 P CD	0.88
L6 WPR CS	0.98
L6 WPR CSS	0.96
L6 WPR CD	0.91

Applying Lumen Multipliers to Calculate Delivered Lumens								
Base Fixture Delivered Lumens (from Performance Table)	x	CCT Multiplier	x	CRI Multiplier	x	Trim Multiplier	=	Delivered Lumens for Desired Fixture and Reflector
<b>Example: L6 23LM 30K MVOLT 90CRI G4 ZT HM CD</b>								
2486 Lumens	x	0.96	x	0.83	x	0.84	=	1664 Lumens

**HYPERBOLIC PHOTOMETRICS**

**Distribution Curve      Distribution Data      Output Data      Coefficient of Utilization      Illuminance Data at 30" Above Floor for a Single Luminaire**

**L6 13LM 35K + L6 HM CS, 3500K LEDs, input watts: 11.74, delivered lumens: 1355.1, LM/W = 115.4, Spacing Criteria: 0.7, test no. PR07172088, tested in accordance to IESNA LM-79.**

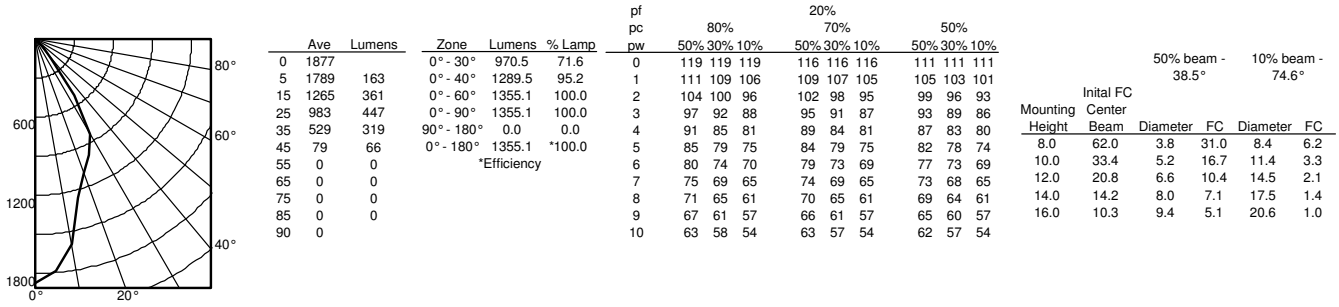

**L6 13LM 35K + L6 HW CS, 3500K LEDs, input watts: 11.74, delivered lumens: 1354.4, LM/W = 115.4, Spacing Criteria: 1.1, test no. PR07172089, tested in accordance to IESNA LM-79.**

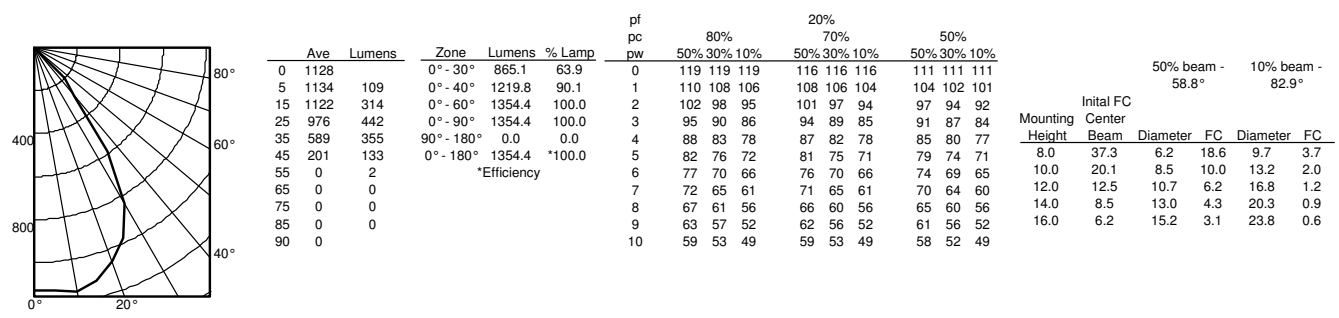

**HYPERBOLIC PHOTOMETRICS**

**Distribution Curve      Distribution Data      Output Data      Coefficient of Utilization      Illuminance Data at 30" Above Floor for a Single Luminaire**

**L6 45LM 35K + L6 HM CS, 3500K LEDs, input watts: 41.41, delivered lumens: 4461.1, LM/W =107.7, Spacing Criteria: 0.9, test no. PR07172082, tested in accordance to IESNA LM-79.**

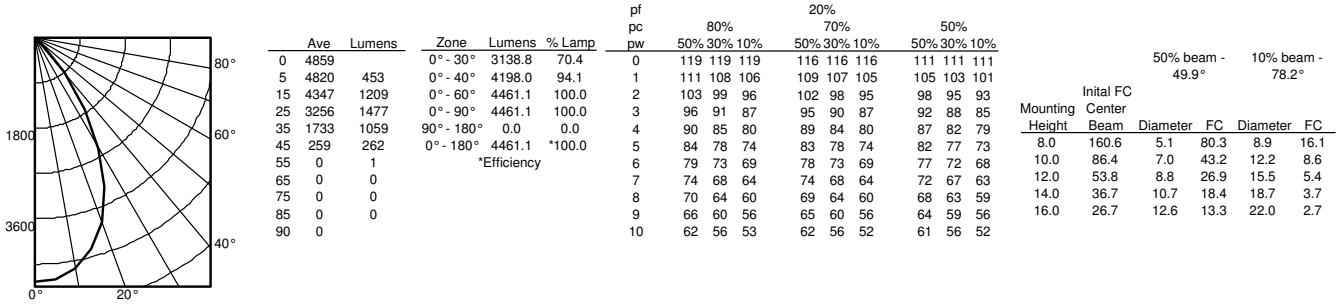

**L6 45LM 35K + L6 HW CS, 3500K LEDs, input watts: 41.41, delivered lumens: 4436.5, LM/W = 107.1, Spacing Criteria: 1.2, test no. PR07172083, tested in accordance to IESNA LM-79.**

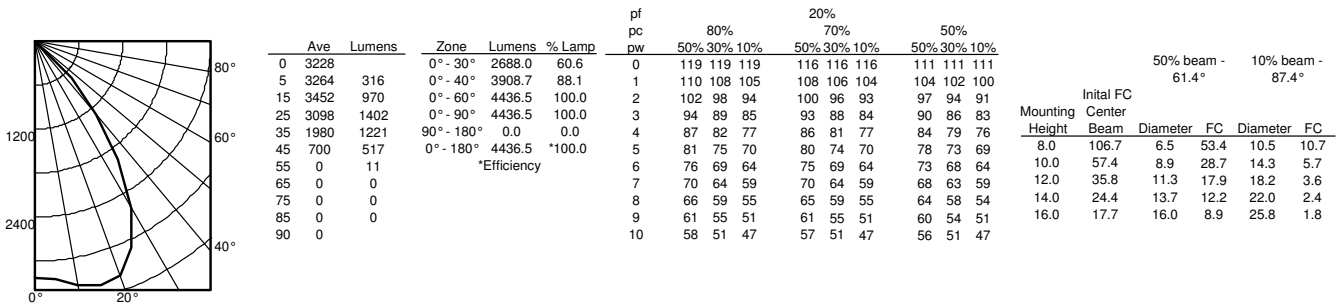

**HYPERBOLIC PHOTOMETRICS**

**Distribution Curve      Distribution Data      Output Data      Coefficient of Utilization      Illuminance Data at 30" Above Floor for a Single Luminaire**

**L6 90LM 35K + L6 HM CS, 3500K LEDs, input watts: 85.03, delivered lumens: 8686.7, LM/W = 102.2, Spacing Criteria: 0.9, test no. PR07172092, tested in accordance to IESNA LM-79.**

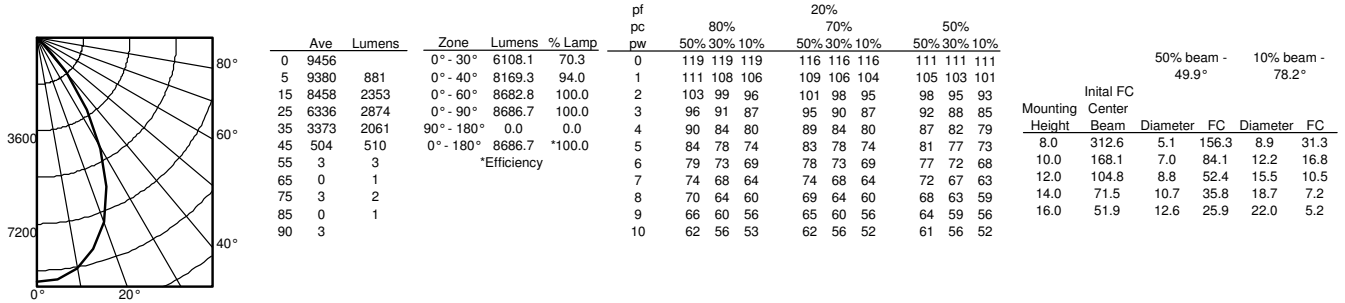

**L6 90LM 35K + L6 HW CS, 3500K LEDs, input watts: 85.03, delivered lumens: 8638.5, LM/W = 101.6, Spacing Criteria: 1.2, test no. PR07172093, tested in accordance to IESNA LM-79.**

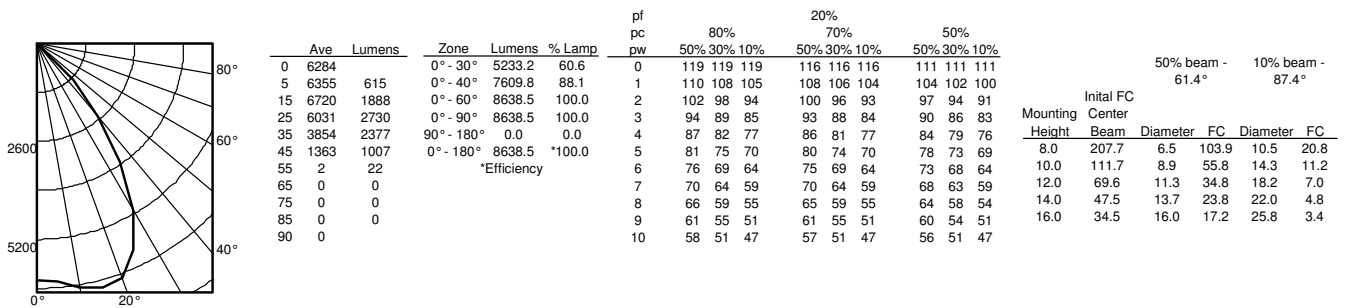



PARABOLIC PHOTOMETRICS

Distribution Curve      Distribution Data      Output Data      Coefficient of Utilization      Illuminance Data at 30" Above Floor for a Single Luminaire

L6 13LM 35K + L6 P CS, 3500K LEDs, input watts: 11.74, delivered lumens: 1118.7, LM/W = 95.3, Spacing Criteria: 1.0, test no. PR07172051, tested in accordance to IESNA LM-79.

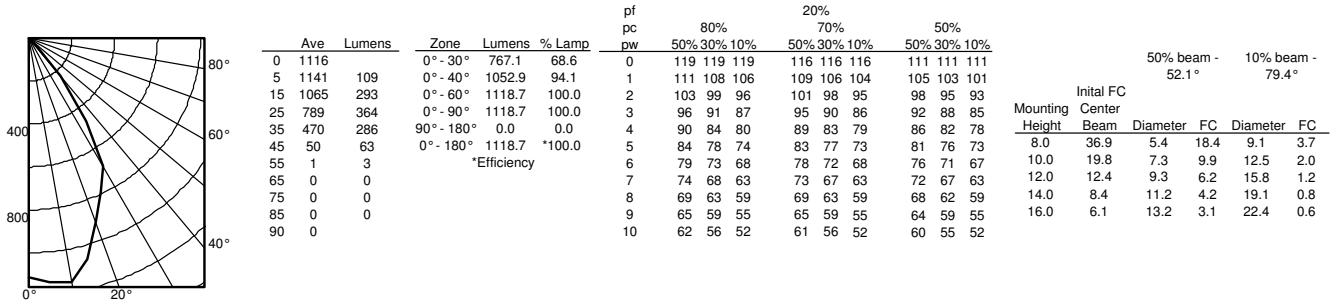

L6 13LM 35K + L6 WPR CS, 3500K LEDs, input watts: 11.74, delivered lumens: 1086.2, LM/W = 92.5, Spacing Criteria: 1.4, test no. PR1171491P8, tested in accordance to IESNA LM-79.

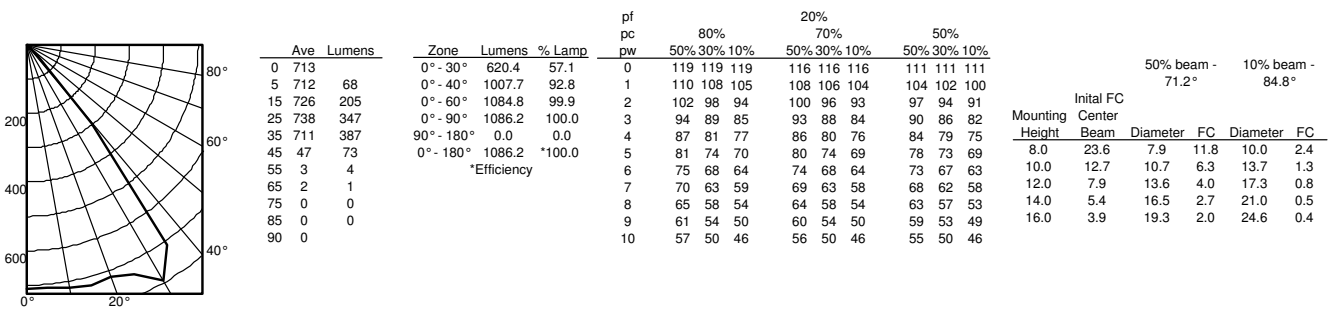

PARABOLIC PHOTOMETRICS

Distribution Curve      Distribution Data      Output Data      Coefficient of Utilization      Illuminance Data at 30" Above Floor for a Single Luminaire

L6 45LM 35K + L6 P CS, 3500K LEDs, input watts: 41.41, delivered lumens: 3636.4, LM/W = 87.8, Spacing Criteria: 1.0, test no. PR07172084, tested in accordance to IESNA LM-79.

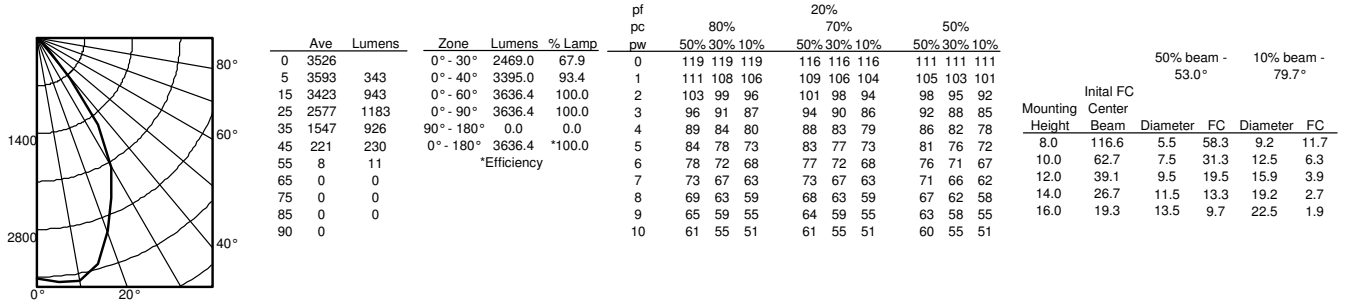

L6 45LM 35K + L6 WPR CS, 3500K LEDs, input watts: 41.41, delivered lumens: 3613.7, LM/W = 87.3, Spacing Criteria: 1.4, test no. PR1170991P3, tested in accordance to IESNA LM-79.

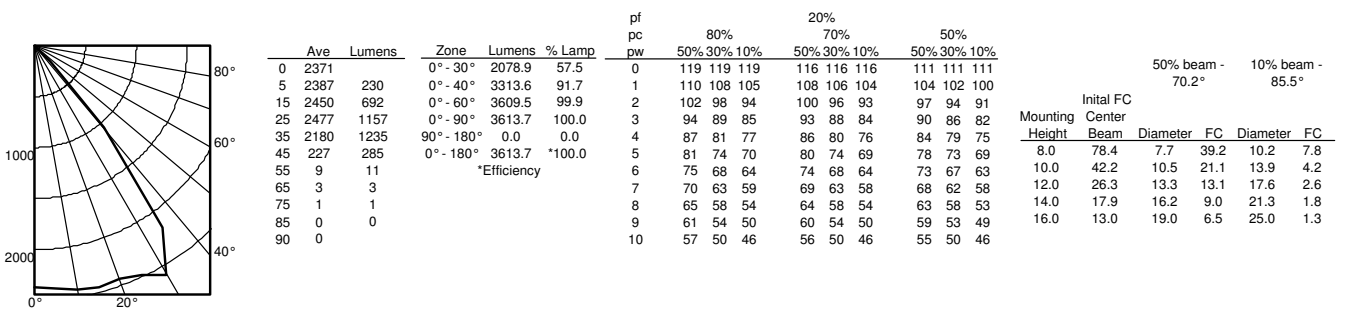

PARABOLIC PHOTOMETRICS

Distribution Curve      Distribution Data      Output Data      Coefficient of Utilization      Illuminance Data at 30" Above Floor for a Single Luminaire

**L6 90LM 35K + L6 P CS**, 3500K LEDs, input watts: 85.03, delivered lumens: 7081.2, LM/W = 83.3, Spacing Criteria: 1.0, test no. PR07172094, tested in accordance to IESNA LM-79.

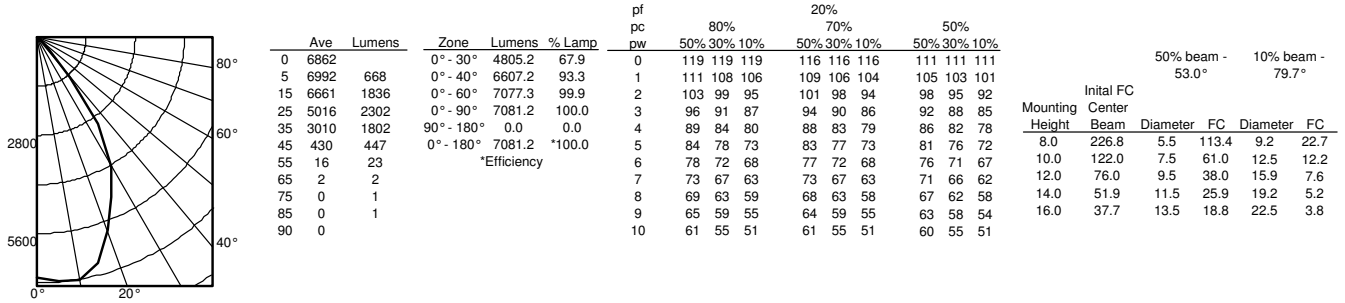

**L6 90LM 35K + L6 WPR CS**, 3500K LEDs, input watts: 85.03, delivered lumens: 7085.7, LM/W = 83.3, Spacing Criteria: 1.4, test no. PR11170991, tested in accordance to IESNA LM-79.

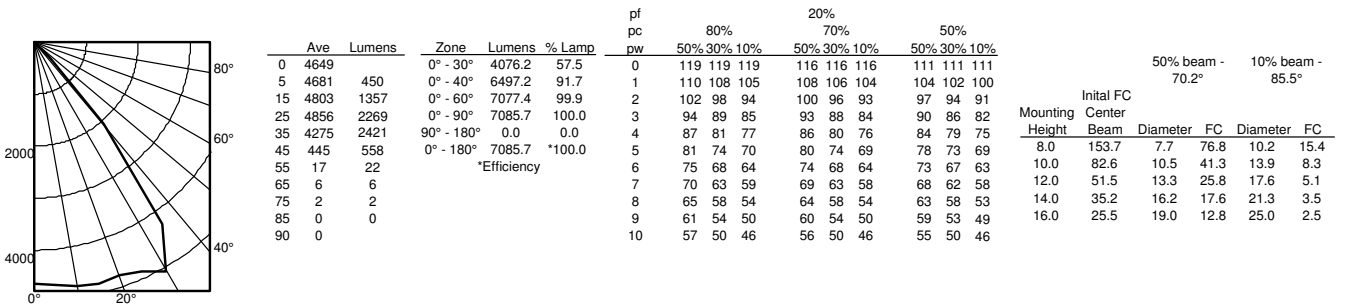

**PERFORMANCE DATA**

**LUMINAIRES SPACED 2' FROM WALL**

Catalog Number: L6 90LM 35K 120 G4 80CRI ZT; L6 HWS CS Spread: Single Wall Test #: PR07172096

Single Unit						Lamp	Multiple Units On 2' Centers*			Multiple Units On 3' Centers*			Multiple Units On 4' Centers*		
Lateral Distance From Fixture 2' From Wall						BXRC-35E1OK0-D-73-SE	Spaced 2' From Wall			Spaced 2' From Wall			Spaced 2' From Wall		
0'	1'	2'	3'	4'	5'	Distance From Ceiling	CL	CL	CL	CL	CL	CL	CL	CL	CL
90	66	31	12	6	6	1'	154	149	154	111	100	111	100	60	100
142	107	54	21	10	8	2'	257	252	257	182	166	182	157	109	157
110	86	47	22	12	9	3'	215	212	215	153	142	153	129	97	129
81	71	44	23	12	9	4'	179	182	179	124	127	124	100	90	100
50	54	40	23	14	10	5'	141	154	141	95	108	95	71	83	71
36	42	33	23	15	11	6'	119	130	119	81	94	81	60	70	60
28	34	28	21	15	11	7'	103	113	103	71	82	71	54	61	54
23	29	24	18	14	12	8'	89	99	89	62	73	62	47	51	47
18	22	19	15	12	10	9'	71	80	71	50	61	50	38	42	38
12	16	14	11	10	7	10'	53	60	53	38	47	38	28	34	28

**LUMINAIRES SPACED 3' FROM WALL**

Catalog Number: L6 90LM 35K 120 G4 80CRI ZT; L6 HWS CS Spread: Single Wall Test #: PR07172096

Single Unit						Lamp	Multiple Units On 3' Centers*			Multiple Units On 4' Centers*			Multiple Units On 6' Centers*		
Lateral Distance From Fixture 3' From Wall						BXRC-35E1OK0-D-73-SE	Spaced 3' From Wall			Spaced 3' From Wall			Spaced 3' From Wall		
0'	1'	2'	3'	4'	5'	Distance From Ceiling	CL	CL	CL	CL	CL	CL	CL	CL	CL
31	28	19	12	8	7	1'	54	54	54	44	42	44	34	20	34
67	58	40	25	14	10	2'	116	113	116	91	86	91	72	43	72
67	60	43	28	17	12	3'	124	123	124	97	91	97	73	51	73
57	51	38	26	17	13	4'	108	108	108	85	83	85	63	47	63
50	45	34	25	17	12	5'	98	98	98	78	75	78	57	45	57
40	40	32	24	17	13	6'	87	92	87	67	72	67	48	44	48
30	33	29	23	17	14	7'	77	86	77	57	67	57	39	42	39
24	28	25	21	16	14	8'	68	78	68	51	61	51	34	38	34
19	22	20	17	14	12	9'	56	66	56	42	51	42	29	32	29
13	17	16	12	11	10	10'	45	50	45	33	40	33	22	26	22

**LUMINAIRES SPACED 4' FROM WALL**

Catalog Number: L6 90LM 35K 120 G4 80CRI ZT; L6 HWS CS Spread: Single Wall Test #: PR07172096

Single Unit						Lamp	Multiple Units On 3' Centers*			Multiple Units On 4' Centers*			Multiple Units On 6' Centers*		
Lateral Distance From Fixture 4' From Wall						BXRC-35E1OK0-D-73-SE	Spaced 4' From Wall			Spaced 4' From Wall			Spaced 4' From Wall		
0'	1'	2'	3'	4'	5'	Distance From Ceiling	CL	CL	CL	CL	CL	CL	CL	CL	CL
17	16	13	10	8	7	1'	35	36	35	29	29	29	22	18	22
36	32	26	19	14	11	2'	75	74	75	60	57	60	44	37	44
45	42	34	26	19	14	3'	98	99	98	78	76	78	56	50	56
42	39	32	25	19	15	4'	95	96	95	76	74	76	54	49	54
38	35	30	24	19	15	5'	86	89	86	69	69	69	49	45	49
35	32	28	22	18	15	6'	82	83	82	65	65	65	46	43	46
33	30	26	22	17	14	7'	78	79	78	62	62	62	44	41	44
26	27	24	20	16	14	8'	70	76	70	55	59	55	38	38	38
20	21	20	17	14	13	9'	58	65	58	45	51	45	31	33	31
14	16	16	14	12	11	10'	46	50	46	35	40	35	24	29	24

\*Based on minimum of five luminaires. Reflectances: 80, 50, 20. Values are rounded to nearest whole footcandle.

Fixtures tested to IES recommended standard for solid state lighting per LM-79-08. Photometric performance on a single unit represents a baseline of performance for the fixture. Results may vary in the field.

**PERFORMANCE DATA**

**LUMINAIRES SPACED 2' FROM WALL**

Catalog Number: L6 90LM 35K 120 G4 80CRI ZT; L6 WS CD Spread: Single Wall Test #: PR07172097

Single Unit							Lamp	Multiple Units On 2' Centers*			Multiple Units On 3' Centers*			Multiple Units On 4' Centers*		
Lateral Distance From Fixture 2' From Wall							BXRC-35E1OK0-D-73-SE	Spaced 2' From Wall			Spaced 2' From Wall			Spaced 2' From Wall		
0'	1'	2'	3'	4'	5'	Distance From Ceiling	CL	CL	CL	CL	CL	CL	CL	CL	CL	
60	43	20	9	6	6	1'	99	96	99	74	63	74	68	38	68	
118	86	42	17	9	8	2'	205	199	205	149	130	149	131	83	131	
119	89	45	21	12	9	3'	213	211	213	157	139	157	136	91	136	
88	79	50	24	13	10	4'	195	200	195	133	142	133	107	100	107	
50	55	45	27	16	11	5'	152	161	152	102	116	102	73	92	73	
36	40	34	27	18	13	6'	124	133	124	87	95	87	63	74	63	
27	31	28	23	18	14	7'	104	111	104	74	82	74	57	61	57	
22	25	23	19	16	14	8'	88	95	88	63	71	63	50	50	50	
17	19	18	15	13	12	9'	69	75	69	51	58	51	40	40	40	
11	14	13	11	11	8	10'	50	55	50	38	43	38	29	33	29	

**LUMINAIRES SPACED 3' FROM WALL**

Catalog Number: L6 90LM 35K 120 G4 80CRI ZT; L6 WS CD Spread: Single Wall Test #: PR07172097

Single Unit							Lamp	Multiple Units On 3' Centers*			Multiple Units On 4' Centers*			Multiple Units On 6' Centers*		
Lateral Distance From Fixture 3' From Wall							BXRC-35E1OK0-D-73-SE	Spaced 3' From Wall			Spaced 3' From Wall			Spaced 3' From Wall		
0'	1'	2'	3'	4'	5'	Distance From Ceiling	CL	CL	CL	CL	CL	CL	CL	CL	CL	
20	18	13	9	7	6	1'	35	35	35	29	28	29	23	13	23	
51	44	29	18	11	9	2'	85	82	85	68	63	68	54	30	54	
59	51	36	24	15	11	3'	103	101	103	83	76	83	63	41	63	
60	52	37	24	16	12	4'	105	104	105	85	79	85	65	44	65	
56	51	38	26	17	13	5'	106	107	106	83	82	83	62	46	62	
43	43	36	27	19	14	6'	95	100	95	72	80	72	50	50	50	
30	33	31	26	20	16	7'	83	90	83	63	71	63	40	48	40	
24	27	25	23	18	16	8'	72	80	72	56	63	56	36	42	36	
18	21	20	18	16	14	9'	59	67	59	46	52	46	31	33	31	
13	16	15	12	13	12	10'	47	51	47	36	41	36	24	26	24	

**LUMINAIRES SPACED 4' FROM WALL**

Catalog Number: L6 90LM 35K 120 G4 80CRI ZT; L6 WS CD Spread: Single Wall Test #: PR07172097

Single Unit							Lamp	Multiple Units On 3' Centers*			Multiple Units On 4' Centers*			Multiple Units On 6' Centers*		
Lateral Distance From Fixture 4' From Wall							BXRC-35E1OK0-D-73-SE	Spaced 4' From Wall			Spaced 4' From Wall			Spaced 4' From Wall		
0'	1'	2'	3'	4'	5'	Distance From Ceiling	CL	CL	CL	CL	CL	CL	CL	CL	CL	
12	11	9	8	7	7	1'	24	25	24	20	20	20	16	13	16	
27	24	19	15	11	10	2'	53	53	53	44	42	44	34	27	34	
37	34	27	21	16	12	3'	77	77	77	61	60	61	46	39	46	
38	35	28	22	17	14	4'	82	82	82	65	64	65	47	42	47	
38	35	29	22	18	14	5'	83	84	83	66	66	66	49	43	49	
39	36	30	23	18	15	6'	86	86	86	68	67	68	50	44	50	
35	33	29	24	19	15	7'	85	86	85	67	68	67	47	45	47	
27	28	26	22	19	16	8'	76	82	76	60	64	60	41	43	41	
20	21	21	19	17	15	9'	63	69	63	49	55	49	33	36	33	
14	16	17	15	14	12	10'	50	54	50	39	43	39	27	32	27	

\*Based on minimum of five luminaires. Reflectances: 80, 50, 20. Values are rounded to nearest whole footcandle.

Fixtures tested to IES recommended standard for solid state lighting per LM-79-08. Photometric performance on a single unit represents a baseline of performance for the fixture. Results may vary in the field.

**CONTROLS**

**EXAMPLE**

Group Fixture Control\*

\*Application diagram applies for fixtures with eldoLED drivers only.

**nPS 80 EZ** Dimming/Control Pack (qty: 2 required)

**nPODM 2P DX** Dual On/Off/Dim Push-Button WallPod

**nCM ADCX** Daylight Sensor with Automatic Dimming Control

**nCM PDT 9** Dual Technology Occupancy Sensor

**Description:** This design provides a dual on/off/dim wall station that enables manual control of the fixtures in Row A and Row B separately. Additionally, a daylight harvesting sensor is provided so the lights in Row B can be configured to dim automatically when daylight is available. An occupancy sensor turns off all lights when the space is vacant.

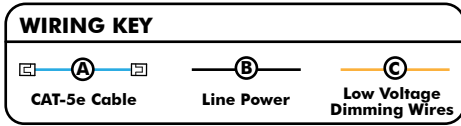
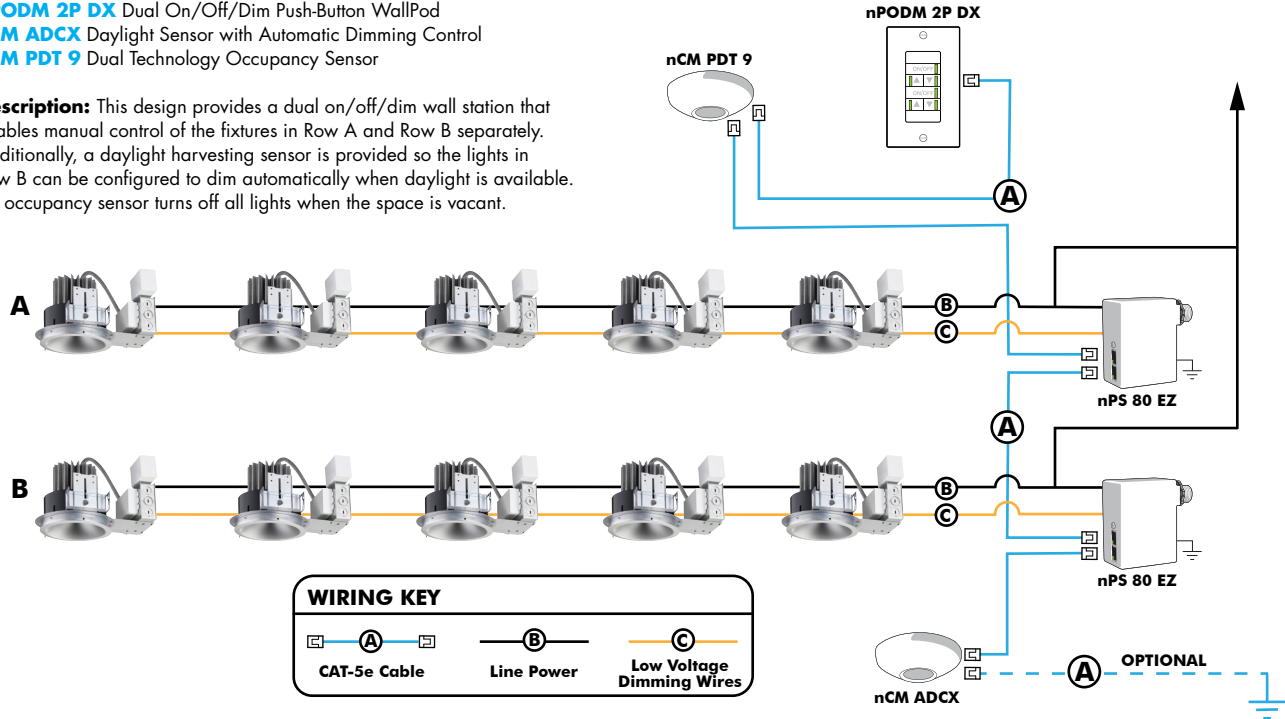

**Choose Wall Controls**

nLight offers multiple styles of wall controls - each with varying features and user experience.



**Push-Button Wallpod**  
Traditional tactile buttons and LED user feedback



**Graphic Wallpod**  
Full color touch screen provides a sophisticated look and feel

**nLight® Wired Controls Accessories:**

Order as separate catalog number. Visit <a href="http://www.acuitybrands.com/products/controls/nlight">www.acuitybrands.com/products/controls/nlight</a> for complete listing of nLight controls.			
WallPod Stations	Model number	Occupancy sensors	Model Number
On/Off	nPODM (Color)	Small motion 360°, ceiling (PIR/dual Tech)	nCM 9 / nCM PDT 9
On/Off & Raise/Lower	nPOD DX (Color)	Large motion 360°, ceiling (PIR/dual tech)	nCM 10 / nCM PDT 10
Graphic Touchscreen	nPOD GFX (Color)	Wide View (PIR/dual tech)	nWV 16 / nWV PDT 16
<b>Photocell controls</b>	<b>Model Number</b>	Wall Switch w/ Raise/Lower (PIR/dual tech)	nWSX LV DX / nWSX PDT LV DX
Dimming	nCM ADCX	<b>Cat-5 cables (plenum rated)</b>	<b>Model Number</b>
		10', CAT5 10FT	CAT5 10FT J1
		15, CAT5 15FT	CAT5 15FT J1



**Capable Luminaire**

This item is an A+ capable luminaire, which has been designed and tested to provide consistent color appearance and out-of-the-box control compatibility with simple commissioning.

- All configurations of this luminaire meet the Acuity Brand's specification for chromatic consistency.
- This luminaire is part of an A+ Certified solution for nLight control networks when ordered with drivers marked by a Shaded background\*
- This Luminaire is part of an A+ Certified solution for nLight control networks, providing advanced control functionality at the luminaire level, when selection includes driver and control options marked by a shaded background\*

To learn more about A+, visit [www.acuitybrands.com/aplus](http://www.acuitybrands.com/aplus).

\*See ordering tree for details

**nLight® AIR Control Accessories:**

Order as separate catalog number. Visit [www.acuitybrands.com/products/controls/nlightair](http://www.acuitybrands.com/products/controls/nlightair).

Wall switches	Model number
On/Off single pole	rPODB [color]
On/Off two pole	rPODB 2P [color]
On/Off & raise/lower single pole	rPODB DX [color]
On/Off & raise/lower two pole	rPODB 2P DX [color]
On/Off & raise/lower single pole	rPODBZ DX WH <sup>1</sup>

**Notes**

1 Can only be ordered with the RES7Z zone control sensor version.

**nLight AIR**

nLight AIR is the ideal solution for retrofit or new construction spaces where adding communication is cost prohibitive. The integrated nLight AIR rPP20 Power Pack is part of each Indy L-Series Luminaire. These individually addressable controls offer the ultimate in flexibility during initial setup and for space repurposing.



Simple as 1,2,3

1. Install the nLight® AIR fixtures with embedded smart sensor
2. Install the wireless battery-powered wall switch
3. With CLAIRITY app, pair the fixtures with the wall switch and if desired, customize the sensor settings for the desired outcome

