



RSX2 LED Area Luminaire



Catalog Number
Notes
Type

Hit the Tab key or mouse over the page to see all interactive elements.

Specifications

EPA (ft ² @0°):	0.69 ft ² (0.06 m ²)
Length:	29.3" (74.4 cm) (SPA mount)
Width:	13.4" (34.0 cm)
Height:	3.0" (7.6 cm) Main Body 7.2" (18.3 cm) Arm
Weight: (SPA mount)	30.0 lbs (13.6 kg)

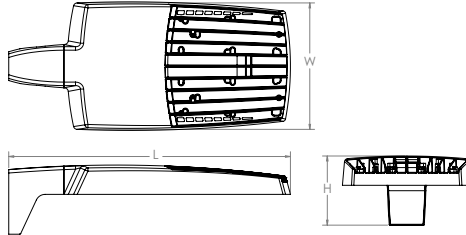

Introduction

The new RSX LED Area family delivers maximum value by providing significant energy savings, long life and outstanding photometric performance at an affordable price. The RSX2 delivers 11,000 to 31,000 lumens allowing it to replace 250W to 1000W HID luminaires.

The RSX features an integral universal mounting mechanism that allows the luminaire to be mounted on most existing drill hole patterns. This "no-drill" solution provides significant labor savings. An easy-access door on the bottom of mounting arm allows for wiring without opening the electrical compartment. A mast arm adaptor, adjustable integral slipfitter and other mounting configurations are available.



Items marked by a shaded background qualify for the Design Select program and ship in 15 days or less. To learn more about Design Select, visit www.acuitybrands.com/designselect.
*See ordering tree for details

Ordering Information

EXAMPLE: RSX2 LED P6 40K R3 MVOLT SPA DDBXD

Series	Performance Package	Color Temperature	Distribution	Voltage	Mounting
RSX2 LED	P1 P2 P3 P4 P5 P6	30K 3000K 40K 4000K 50K 5000K	R2 Type 2 Wide R3 Type 3 Wide R3S Type 3 Short R4 Type 4 Wide R4S Type 4 Short R5 Type 5 Wide ¹ R5S Type 5 Short ¹ AFR Automotive Front Row AFRR90 Automotive Front Row Right Rotated AFRL90 Automotive Front Row Left Rotated	MVOLT (120V-277V) ² HVOLT (347V-480V) ³ XVOLT (277V-480V) ⁴ (use specific voltage for options as noted) 120 ³ 277 ⁵ 208 ³ 347 ⁵ 240 ³ 480 ⁵	SPA Square pole mounting (3.0" min. SQ pole for 1 at 90°, 3.5" min. SQ pole for 2, 3, 4 at 90°) RPA Round pole mounting (3.2" min. dia. RND pole for 2, 3, 4 at 90°, 3.0" min. dia. RND pole for 1 at 90°, 2 at 180°, 3 at 120°) MA Mast arm adaptor (fits 2-3/8" OD horizontal tenon) IS Adjustable slipfitter (fits 2-3/8" OD tenon) ⁶ WBA Wall bracket ¹ WBASC Wall bracket with surface conduit box AASP Adjustable tilt arm square pole mounting ⁶ AARP Adjustable tilt arm round pole mounting ⁶ AAWB Adjustable tilt arm with wall bracket ⁶ AAWSC Adjustable tilt arm wall bracket and surface conduit box ⁶

Options	Finish
<p>Shipped Installed</p> <p>HS House-side shield⁷</p> <p>PE Photocontrol, button style^{8,9}</p> <p>PER7 Seven-wire twist-lock receptacle only (no controls)^{9,10,11}</p> <p>SF Single fuse (120, 277, 347)⁵</p> <p>DF Double fuse (208, 240, 480)⁵</p> <p>SPD20KV 20KV Surge pack (10KV standard)</p> <p>FAO Field adjustable output⁹</p> <p>DMG 0-10V dimming extend out back of housing for external control (control ordered separate)⁹</p> <p>DS Dual switching^{9,12}</p>	<p>DDBXD Dark Bronze</p> <p>DBLXD Black</p> <p>DNAXD Natural Aluminum</p> <p>DWHXD White</p> <p>DBBTXD Textured Dark Bronze</p> <p>DBLBXD Textured Black</p> <p>DNATXD Textured Natural Aluminum</p> <p>DWHGXD Textured White</p>
<p>Shipped Installed</p> <p>*Standalone and Networked Sensors/Controls (factory default settings, see table page 9)</p> <p>NLTAIR2 PIRHN nLight AIR generation 2, with Networked, Bi-Level motion/ambient sensor^{9,13,14,15}</p> <p>BAA Buy America(n) Act and/or Build America Buy America Qualified</p> <p>CCE Coastal Construction¹⁶</p> <p>*Note: NLTAIR2 PIRHN with nLight Air can be used as a standalone dimming sensor with out-of-box settings or as a wireless networked solution. See factory default settings table. Sensor coverage pattern is affected when luminaire is tilted.</p> <p>Shipped Separately (requires some field assembly)</p> <p>EGS External glare shield⁷</p> <p>EGFV External glare full visor (360° around light aperture)⁷</p> <p>BS Bird spikes¹⁷</p>	



Ordering Information

Accessories

Ordered and shipped separately.

RSX2HS	RSX2 House side shield (includes 2 shields)
RSX2EGS (FINISH) U	External glare shield (specify finish)
RSX2HSFRR (FINISH) U	RSX2 House side shields for AFR rotated optics (includes 2 shields)
RSX2EGFV (FINISH) U	External glare full visor (specify finish)
RSXRPA (FINISH) U	RSX Universal round pole adaptor plate (specify finish)
RSXWBA (FINISH) U	RSX WBA wall bracket (specify finish) ¹
RSXSBC (FINISH) U	RSX Surface conduit box (specify finish, for use with WBA, WBA not included)
DLL127F 1.5 JU	Photocell -SSL twist-lock (120-277V) ¹⁸
DLL347F 1.5 CULJU	Photocell -SSL twist-lock (347V) ¹⁸
DLL480F 1.5 CULJU	Photocell -SSL twist-lock (480V) ¹⁸
DSHORT SBK U	Shorting cap ¹⁸

NOTES

- Any Type 5 distribution, is not available with WBA.
- MVOLT driver operates on any line voltage from 120-277V (50/60 Hz).
- HVOLT driver operates on any line voltage from 347-480V (50/60 Hz).
- XVOLT driver not available with P1. XVOLT driver operates on any line voltage from 277V-480V (50/60 Hz). XVOLT not available with fusing (SF or DF) and not available with PE.
- Single fuse (SF) requires 120V, 277V or 347V. Double fuse (DF) requires 208V, 240V or 480V.
- Maximum tilt is 90° above horizontal.
- It may be ordered as an accessory.
- Requires MVOLT or 347V.
- Two or more of the following options cannot be combined including PE, DMG, PER7, FAO, DS and NLTAIR2 PIRHN. (Exception: PE and FAO can be combined; also PE and DMG can be combined.)
- Compatible with standard twist-lock photocells for dusk to dawn operation or advanced control nodes that provide 0-10V dimming signals. Wire 4/Wire 5 wired to dimming leads on driver. Wire 6/Wire 7 capped inside luminaire. Twistlock photocell ordered and shipped

- as a separate line item from Acuity Brands Controls. See accessories. Shorting Cap included.
- For units with option PER7, the mounting must be restricted to +/- 45° from horizontal aim per ANSI C136.10-2010.
 - DS requires (2) separately switched circuits. DS provides 50/50 fixture operation via (2) different sets of leads using (2) drivers. DS only available with packages P5 and P6.
 - Must be ordered with PIRHN.
 - Requires MVOLT or HVOLT.
 - Must be ordered with NLTAIR2. For additional information on PIRHN visit [here](#).
 - CCE option not available with WBA, WBASC, AASP, AARP, AAWB, AAWBSC, EGS, EGFV and BS.
 - Must be ordered with fixture for factory pre-drilling.
 - Requires luminaire to be specified with PER7 option. Ordered and shipped as a separate line item from Acuity Brands Controls.

External Shields

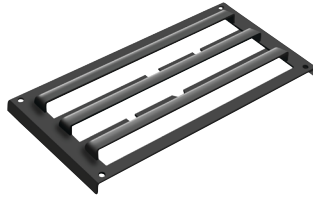

House Side Shield



External Glare Shield



External 360 Full Visor

Pole/Mounting Information

Accessories including bullhorns, cross arms and other adapters are available under the accessories tab at Lithonia's Outdoor Poles and Arms product page. Click here to visit [Accessories](#).

HANDHOLE ORIENTATION

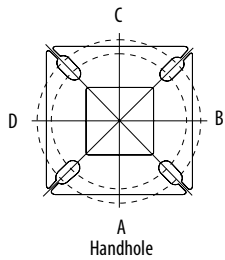

RSX POLE DRILLING

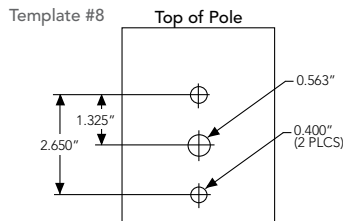

RSX STANDARD ARM & ADJUSTABLE ARM

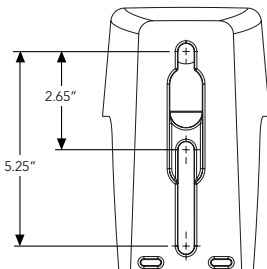

Round Tenon Mount - Pole Top Slipfitters

Tenon O.D.	RSX Mounting	Single	2 at 180°	2 at 90°	3 at 120°	3 at 90°	4 at 90°
2 - 3/8"	RPA, AARP	AS3-5 190	AS3-5 280	AS3-5 290	AS3-5 320	AS3-5 390	AS3-5 490
2 - 7/8"	RPA, AARP	AST25-190	AST25-280	AST25-290	AST25-320	AST25-390	AST25-490
4"	RPA, AARP	AST35-190	AST35-280	AST35-290	AST35-320	AST35-390	AST35-490

Drill/Side Location by Configuration Type

Drilling Template	Mounting Option	Single	2 @ 180	2 @ 90	3 @ 120	3 @ 90	4 @ 90
	Head Location	Side B	Side B & D	Side B & C	Round Pole Only	Side B, C & D	Side A, B, C & D
#8	Drill Nomenclature	DM19AS	DM28AS	DM29AS	DM32AS	DM39AS	DM49AS

RSX2 - Luminaire EPA

*Includes luminaire and integral mounting arm. Other tenons, arms, brackets or other accessories are not included in this EPA data.

Fixture Quantity & Mounting Configuration	Single	2 @ 90	2 @ 180	3 @ 90	3 @ 120	4 @ 90	2 Side by Side	3 Side by Side	4 Side by Side	
SPA - Square Pole Adaptor	0.69	1.22	1.27	1.8	1.61	2.39	1.37	2.06	2.74	
RPA - Round Pole Adaptor	0.74	1.27	1.37	1.9	1.71	2.49	1.42	2.16	2.84	
MA - Mast Arm Adaptor	0.61	1.14	1.11	1.64	1.45	2.23	1.29	1.9	2.58	
IS - Integral Slipfitter AASP/AARP - Adjustable Arm Square/Round Pole	0°	0.69	1.22	1.27	1.8	1.61	2.39	1.37	2.06	2.74
	10°	0.53	1.06	1.05	1.58	1.37	2.08	1.06	1.59	2.12
	20°	0.52	1.02	1.03	1.52	1.33	2.02	1.03	1.55	2.07
	30°	0.64	1.11	1.18	1.63	1.45	2.21	1.27	1.91	2.54
	40°	0.81	1.21	1.35	1.74	1.65	2.39	1.62	2.43	3.23
	45°	0.91	1.25	1.5	1.81	1.75	2.48	1.82	2.73	3.64
	50°	1.34	1.83	2.17	2.61	2.56	3.62	2.68	4.02	5.36
	60°	2.2	2.97	3.57	4.24	4.17	5.89	4.41	6.61	8.82
	70°	2.86	4.13	4.7	5.89	5.71	8.21	5.71	8.57	11.42
	80°	3.4	5.13	5.67	7.34	7.09	10.21	6.79	10.19	13.59
	90°	3.85	5.96	6.55	8.58	8.31	11.88	7.70	11.56	15.41

Photometric Diagrams

To see complete photometric reports or download .ies files for this product, visit Lithonia Lighting's RSX Area homepage.

Isofootcandle plots for the RSX2 LED P6 40K. Distances are in units of mounting height (30').

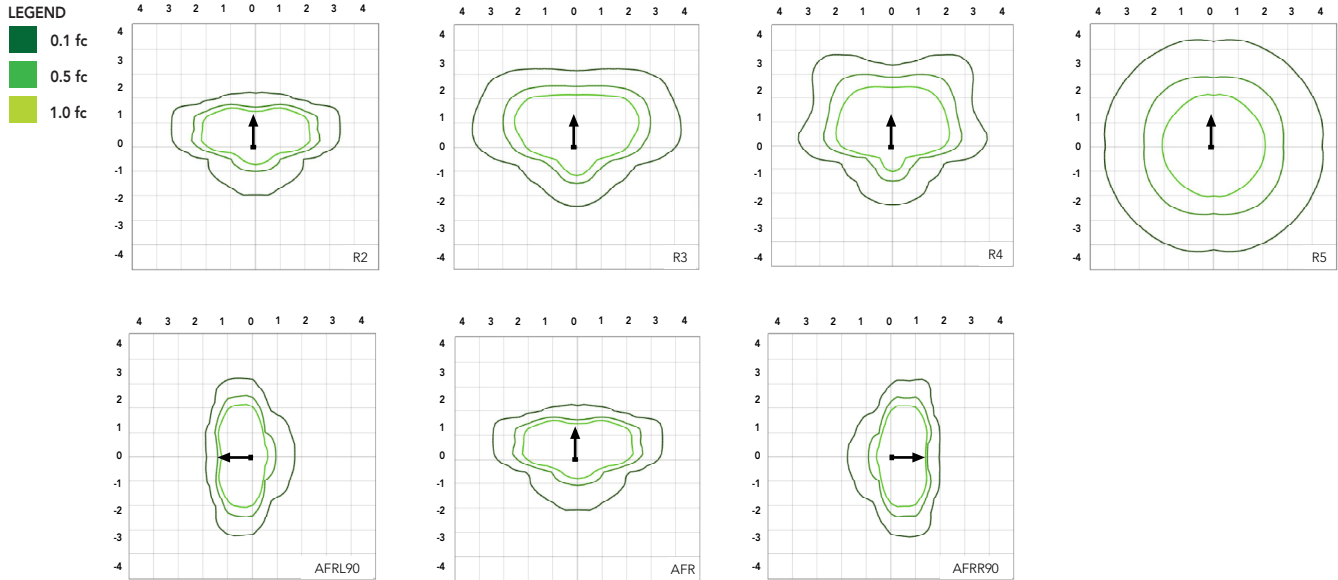

Performance Data

Lumen Ambient Temperature (LAT) Multipliers

Use these factors to determine relative lumen output for average ambient temperatures from 0-50°C (32-122°F).

Ambient	Ambient	Lumen Multiplier
0°C	32°F	1.05
5°C	41°F	1.04
10°C	50°F	1.03
15°C	59°F	1.02
20°C	68°F	1.01
25°C	77°F	1.00
30°C	86°F	0.99
35°C	95°F	0.98
40°C	104°F	0.97
45°C	113°F	0.96
50°C	122°F	0.95

Electrical Load

Performance Package	System Watts (W)	Current (A)					
		120V	208V	240V	277V	347V	480V
P1	71W	0.59	0.34	0.30	0.26	0.20	0.15
P2	111W	0.93	0.53	0.46	0.40	0.32	0.23
P3	147W	1.23	0.70	0.61	0.53	0.42	0.31
P4	187W	1.55	0.90	0.78	0.68	0.53	0.38
P5	210W	1.75	1.01	0.87	0.76	0.60	0.44
P6	244W	2.03	1.17	1.01	0.88	0.70	0.51

Projected LED Lumen Maintenance

Operating Hours	50,000	75,000	100,000
Lumen Maintenance Factor	>0.97	>0.95	>0.92

Values calculated according to IESNA TM-21-11 methodology and valid up to 40°C.



Lumen Output

Lumen values are from photometric tests performed in accordance with IESNA LM-79-08. Data is considered to be representative of the configurations shown, within the tolerances allowed by Lighting Facts. Contact factory for performance data on any configurations not shown here.

Performance Package	System Watts	Distribution Type	30K (3000K, 70 CRI)					40K (4000K, 70 CRI)					50K (5000K, 70 CRI)				
			Lumens	B	U	G	LPW	Lumens	B	U	G	LPW	Lumens	B	U	G	LPW
P1	71W	R2	10,040	2	0	1	139	11,031	2	0	1	153	11,031	2	0	1	153
		R3	10,005	2	0	2	141	10,992	2	0	2	155	10,992	2	0	2	155
		R3S	10,271	2	0	2	143	11,285	2	0	2	157	11,285	2	0	2	157
		R4	10,136	2	0	2	143	11,136	2	0	2	157	11,136	2	0	2	157
		R4S	9,779	2	0	2	138	10,744	2	0	2	151	10,744	2	0	2	151
		R5	10,271	4	0	2	145	11,285	4	0	2	159	11,285	4	0	2	159
		R5S	10,544	3	0	1	149	11,585	3	0	2	163	11,585	3	0	2	163
		AFR	10,026	2	0	1	141	11,016	2	0	1	155	11,016	2	0	1	155
		AFRR90	10,122	3	0	2	140	11,121	3	0	2	154	11,121	3	0	2	154
		AFRL90	10,164	3	0	2	141	11,167	3	0	2	155	11,167	3	0	2	155
P2	111W	R2	15,712	2	0	2	138	17,263	2	0	2	151	17,263	2	0	2	151
		R3	15,657	2	0	3	141	17,202	3	0	3	155	17,202	3	0	3	155
		R3S	16,075	2	0	2	141	17,661	2	0	2	155	17,661	2	0	2	155
		R4	15,862	2	0	3	143	17,427	2	0	3	157	17,427	2	0	3	157
		R4S	15,304	2	0	2	138	16,815	2	0	2	151	16,815	2	0	2	151
		R5	16,075	4	0	2	145	17,661	5	0	3	159	17,661	5	0	3	159
		R5S	16,502	4	0	2	149	18,130	4	0	2	163	18,130	4	0	2	163
		AFR	15,691	2	0	2	141	17,240	2	0	2	155	17,240	2	0	2	155
		AFRR90	15,841	3	0	3	139	17,404	4	0	3	153	17,404	4	0	3	153
		AFRL90	15,907	3	0	3	139	17,477	4	0	3	153	17,477	4	0	3	153
P3	147W	R2	19,855	3	0	2	132	21,814	3	0	2	145	21,814	3	0	2	145
		R3	19,785	3	0	3	135	21,737	3	0	4	148	21,737	3	0	4	148
		R3S	20,312	3	0	3	135	22,317	3	0	3	149	22,317	3	0	3	149
		R4	20,044	3	0	3	136	22,022	3	0	4	150	22,022	3	0	4	150
		R4S	19,339	3	0	3	132	21,247	3	0	3	145	21,247	3	0	3	145
		R5	20,313	5	0	3	138	22,317	5	0	3	152	22,317	5	0	3	152
		R5S	20,852	4	0	2	142	22,910	4	0	2	156	22,910	4	0	2	156
		AFR	19,828	3	0	2	135	21,785	3	0	2	148	21,785	3	0	2	148
		AFRR90	20,017	4	0	3	133	21,992	4	0	3	147	21,992	4	0	3	147
		AFRL90	20,101	4	0	3	134	22,084	4	0	3	147	22,084	4	0	3	147
P4	187W	R2	22,836	3	0	2	120	25,090	3	0	2	132	25,090	3	0	2	132
		R3	22,756	3	0	4	122	25,002	3	0	4	134	25,002	3	0	4	134
		R3S	23,363	3	0	3	123	25,668	3	0	3	135	25,668	3	0	3	135
		R4	23,054	3	0	4	123	25,329	3	0	4	135	25,329	3	0	4	135
		R4S	22,243	3	0	3	119	25,059	3	0	3	134	25,059	3	0	3	134
		R5	23,363	5	0	3	125	25,669	5	0	4	137	25,669	5	0	4	137
		R5S	23,983	4	0	2	128	26,350	4	0	2	141	26,350	4	0	2	141
		AFR	22,806	3	0	2	122	25,056	3	0	2	134	25,056	3	0	2	134
		AFRR90	23,023	4	0	3	121	25,295	4	0	3	133	25,295	4	0	3	133
		AFRL90	23,120	4	0	3	122	25,401	4	0	3	134	25,401	4	0	3	134
P5	210W	R2	26,141	3	0	2	122	28,721	3	0	2	135	28,721	3	0	2	135
		R3	26,049	3	0	4	124	28,620	3	0	4	136	28,620	3	0	4	136
		R3S	26,744	3	0	3	125	29,383	3	0	4	138	29,383	3	0	4	138
		R4	26,390	3	0	4	126	28,994	3	0	4	138	28,994	3	0	4	138
		R4S	25,462	3	0	3	121	27,974	3	0	3	133	27,974	3	0	3	133
		R5	26,744	5	0	4	127	29,383	5	0	4	140	29,383	5	0	4	140
		R5S	27,454	4	0	2	131	30,163	4	0	2	144	30,163	4	0	2	144
		AFR	26,106	3	0	2	124	28,682	3	0	2	137	28,682	3	0	2	137
		AFRR90	26,354	4	0	3	123	28,955	5	0	3	136	28,955	5	0	3	136
		AFRL90	26,465	4	0	3	124	29,077	5	0	3	136	29,077	5	0	3	136
P6	244W	R2	27,646	3	0	2	112	30,374	3	0	2	123	30,374	3	0	2	123
		R3	27,549	3	0	4	113	30,267	3	0	4	124	30,267	3	0	4	124
		R3S	28,283	3	0	3	115	31,075	3	0	4	126	31,075	3	0	4	126
		R4	27,909	3	0	4	114	30,663	3	0	4	126	30,663	3	0	4	126
		R4S	26,928	3	0	3	110	29,585	3	0	3	121	29,585	3	0	3	121
		R5	28,284	5	0	4	116	31,075	5	0	4	127	31,075	5	0	4	127
		R5S	29,035	4	0	2	119	31,900	5	0	3	131	31,900	5	0	3	131
		AFR	27,608	3	0	2	112	30,332	3	0	2	123	30,332	3	0	2	123
		AFRR90	27,872	4	0	3	113	30,622	5	0	3	124	30,622	5	0	3	124
		AFRL90	27,989	4	0	3	113	30,751	5	0	3	125	30,751	5	0	3	125

Dimensions & Weights

Luminaire Weight by Mounting Type

Mounting Configuration	Total Luminaire Weight
SPA	30 lbs
RPA	32 lbs
MA	30 lbs
WBA	33 lbs
WBASC	36 lbs
IS	33 lbs
AASP	33 lbs
AARP	35 lbs
AAWB	36 lbs
AAWSC	39 lbs

RSX2 with Round Pole Adapter (RPA)

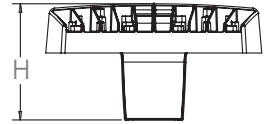
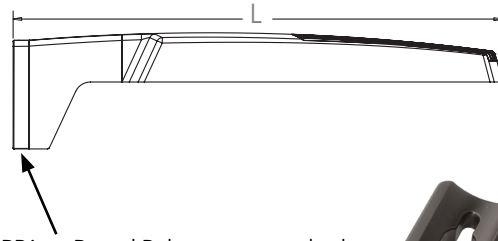
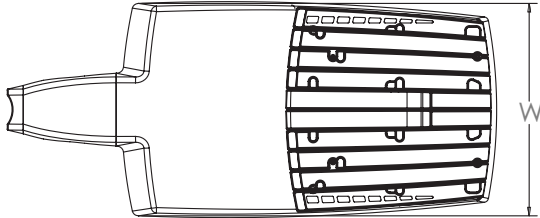

Length: 30.3" (77.0 cm)
 Width: 13.4" (34.0 cm)
 Height: 3.0" (7.6 cm) Main Body
 7.2" (18.3 cm) Arm

Note: RPA — Round Pole mount can also be used to mount on square poles by omitting the round pole adapter plate shown here.

RSX2 with Mast Arm Adapter (MA)

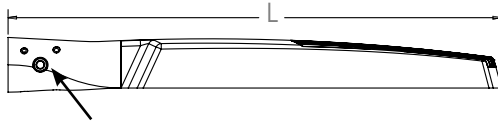
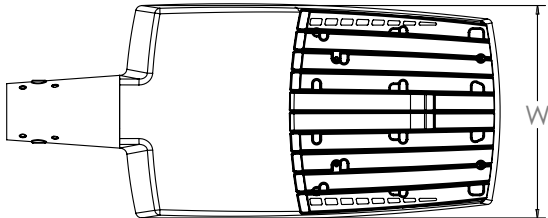

7/16" locking thru bolt/nut provided

Length: 30.6" (77.7 cm)
 Width: 13.4" (34.0 cm)
 Height: 3.0" (7.6 cm) Main Body
 3.5" (8.9 cm) Arm

RSX2 with Adjustable Slipfitter (IS)

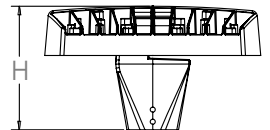
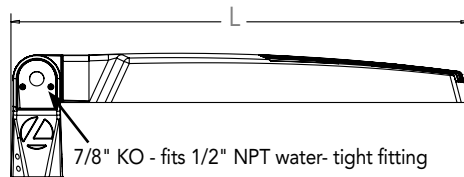
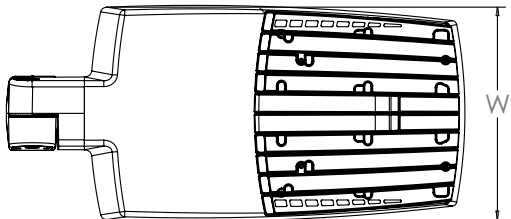

7/8" KO - fits 1/2" NPT water-tight fitting

Length: 28.3" (71.9 cm)
 Width: 13.4" (34.0 cm)
 Height: 3.0" (7.6 cm) Main Body
 7.6" (19.3 cm) Arm

Dimensions

RSX2 with Wall Bracket (WBA)

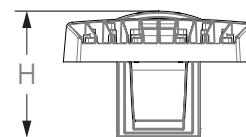
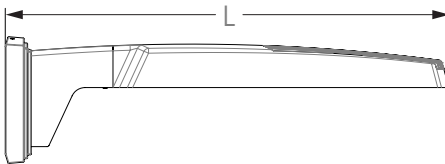
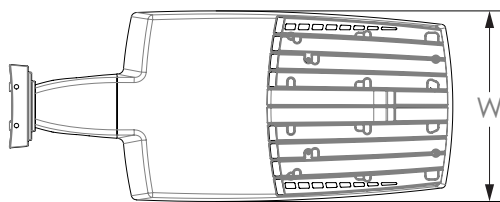

Length: 31.2" (79.2 cm)
 Width: 13.4" (41.7 cm)
 Height: 3.0" (7.6 cm) Main Body
 8.9" (22.6 cm) Arm

Wall Bracket (WBA) Mounting Detail

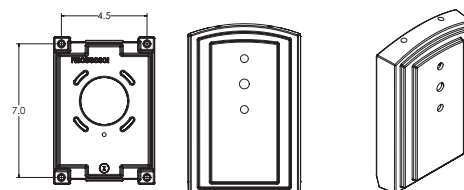

RSX2 with Wall Bracket with Surface Conduit Box (WBASC)

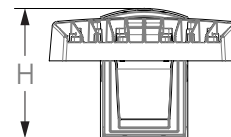
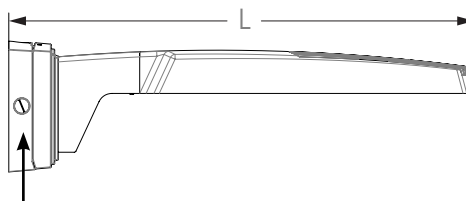
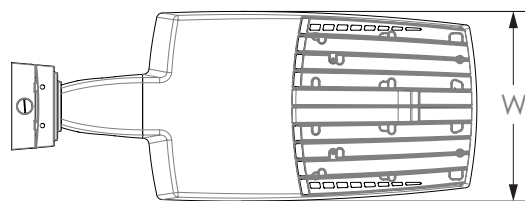

3/4" NPT taps with plugs - Qty (4) provided

Length: 32.8" (83.3 cm)
 Width: 13.4" (41.7 cm)
 Height: 3.0" (7.6 cm) Main Body
 9.2" (23.4 cm) Arm

Surface Conduit Box (SCB) Mounting Detail

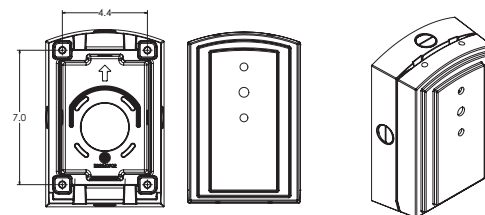

Dimensions

RSX2 with Adjustable Tilt Arm - Square or Round Pole (AASP or AARP)

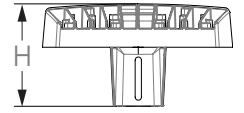
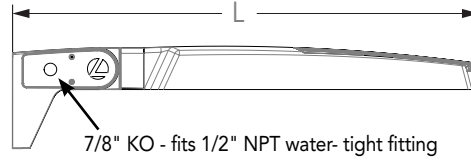
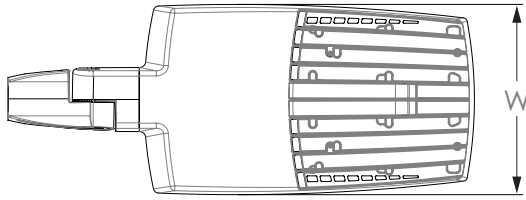

Length: 32.8" (83.3 cm) **AASP**
 33.8" (85.9 cm) **AARP**
 Width: 13.4" (34.0 cm)
 Height: 3.0" (7.6 cm) Main Body
 7.2" (18.2 cm) Arm

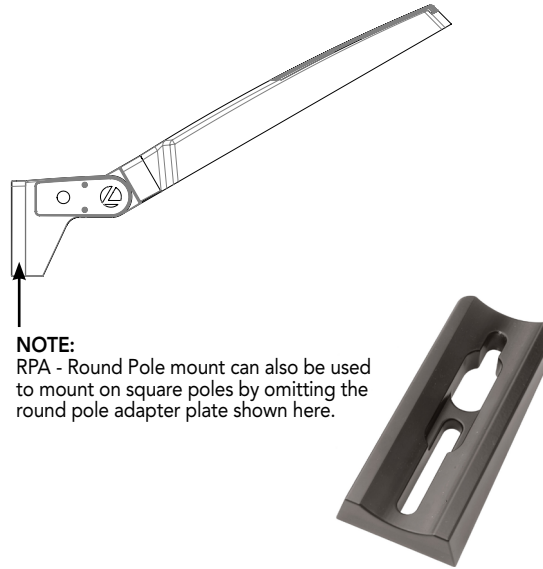

NOTE:
 RPA - Round Pole mount can also be used to mount on square poles by omitting the round pole adapter plate shown here.

Notes

AASP: Requires 3.0" min. square pole for 1 at 90°. Requires 3.5" min. square pole for mounting 2, 3, 4 at 90°.

AARP: Requires 3.2" min. dia. round pole for 2, 3, 4 at 90°. Requires 3.0" min. dia. round pole for mounting 1 at 90°, 2 at 180°, 3 at 120°.

RSX2 with Adjustable Tilt Arm with Wall Bracket (AAWB)

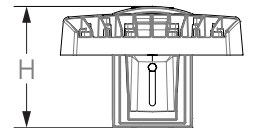
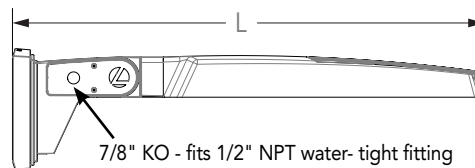
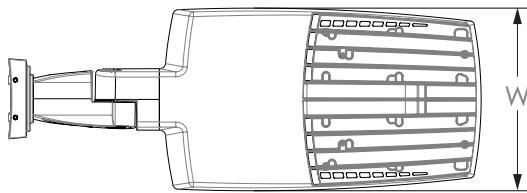

Length: 34.7" (88.0 cm)
 Width: 13.4" (34.0 cm)
 Height: 3.0" (7.6 cm) Main Body
 8.9" (22.6 cm) Arm

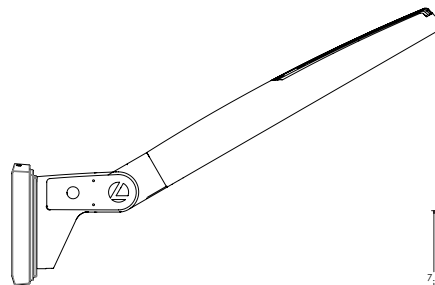

Wall Bracket (WBA) Mounting Detail

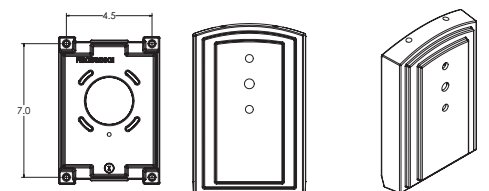

Dimensions

RSX2 with Adjustable Tilt Arm with Wall Bracket and Surface Conduit Box (AAWSC)

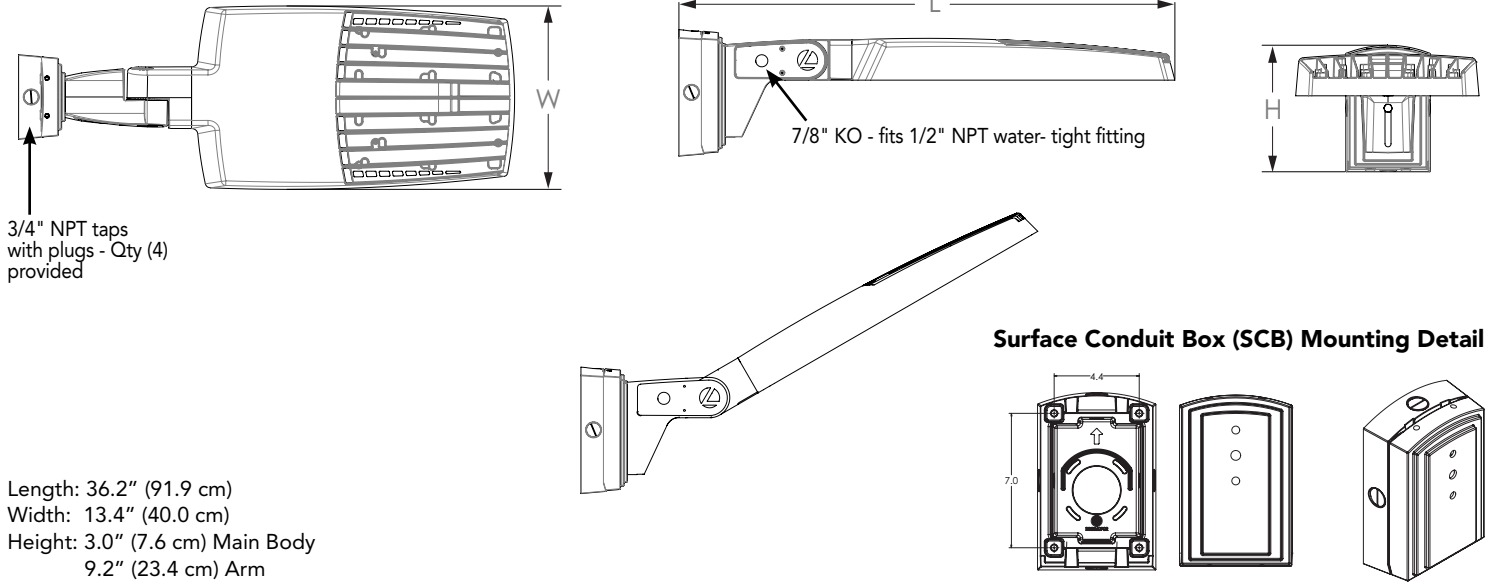

Automotive Front Row - Rotated Optics (AFRL90/R90)

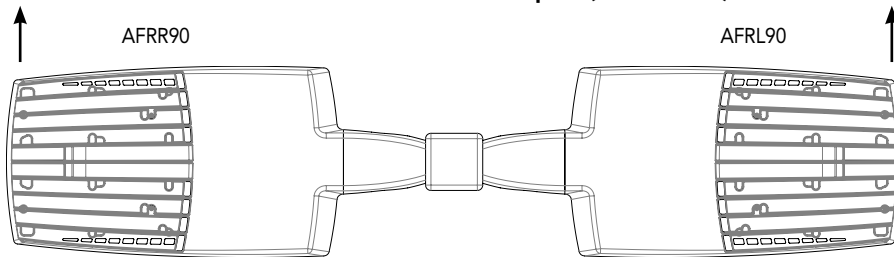

(Example: 2@180 - arrows indicate direction of light exiting the luminaire)

nLight Control - Sensor Coverage and Settings

NLTAIR2 PIRHN nLight Sensor Coverage Pattern nLight PIRHN

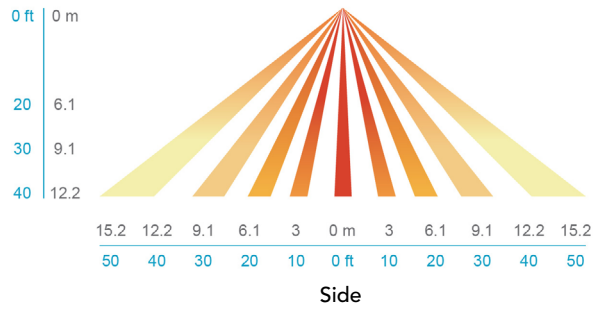
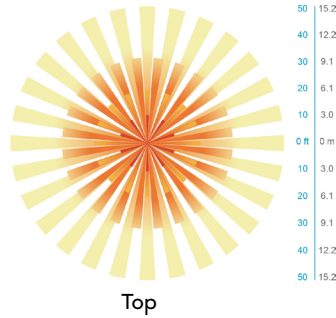
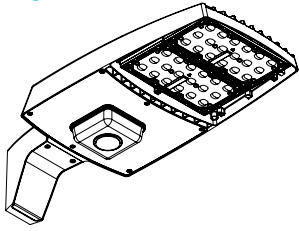

Motion Sensor Default Settings - Option PIRHN						
Option	Dimmed State (unoccupied)	High Level (when occupied)	Photocell Operation	Dwell Time (occupancy time delay)	Ramp-up Time (from unoccupied to occupied)	Ramp-down Time (from occupied to unoccupied)
NLTAIR2 PIRHN	Approx. 30% Output	100% Output	Enabled @ 1.5FC	7.5 minutes	3 seconds	5 minutes

*Note: NLTAIR2 PIRHN default settings including photocell set-point, high/low dim rates, and occupancy sensor time delay are all configurable using the Clarity Pro App. Sensor coverage pattern shown with luminaire at 0°. Sensor coverage pattern is affected when luminaire is tilted.

FEATURES & SPECIFICATIONS

INTENDED USE

The RSX LED area family is designed to provide a long-lasting, energy-efficient solution for the one-for-one replacement of existing metal halide or high pressure sodium lighting. The RSX2 delivers 11,000 to 31,000 lumens and is ideal for replacing 250W to 1000W HID pole-mounted luminaires in parking lots and other area lighting applications.

CONSTRUCTION AND DESIGN

The RSX LED area luminaire features a rugged die-cast aluminum main body that uses heat-dissipating fins and flow-through venting to provide optimal thermal management that both enhances LED performance and extends component life. Integral "no drill" mounting arm allows the luminaire to be mounted on existing pole drillings, greatly reducing installation labor. The light engines and housing are sealed against moisture and environmental contaminants to IP66. The low-profile design results in a low EPA, allowing pole optimization. Vibration rated per ANSI C136.31: 3G Mountings: Include SPA, RPA, MA, IS, AASP, AARP rated for 3G vibration. 1.5G Mountings: Include WBA, WBASC, AAWB and AAWSC rated for 1.5G vibration.

FINISH

Exterior parts are protected by a zinc-infused Super Durable TGIC thermoset powder coat finish that provides superior resistance to corrosion and weathering. A tightly controlled multi-stage process ensures superior adhesion as well as a minimum finish thickness of 3 mils. The result is a high-quality finish that is warranted not to crack or peel.

OPTICS

Precision acrylic refractive lenses are engineered for superior application efficiency, distributing the light to where it is needed most. Available in short and wide pattern distributions including Type 2, Type 3, Type 3S, Type 4, Type 4S, Type 5, Type 5S, AFR (Automotive Front Row) and AFR rotated AFRR90 and ARFL90.

COASTAL CONSTRUCTION (CCE)

Optional corrosion resistant construction is engineered with added corrosion protection in materials and/or pre-treatment of base material under super durable paint. Provides additional corrosion protection for applications near coastal areas. Finish is salt spray tested to over 5,000 hours per ASTM B117 with scribe rating of 10. Additional lead-times apply.

ELECTRICAL

Light engine(s) configurations consist of high-efficiency LEDs mounted on metal-core circuit boards and aluminum heat sinks to maximize heat dissipation. Light engines are IP66 rated. LED lumen maintenance is >L92/100,000 hours. CCT's of 3000K, 4000K and 5000K (minimum 70 CRI) are available. Fixtures ship standard with 0-10v dimming driver. Class 1 electronic drivers ensure system power factor >90% and THD <20%. Easily serviceable 10kV surge protection device meets a minimum Category C Low operation (per ANSI/IEEE C62.41.2).

STANDARD CONTROLS

The RSX LED area luminaire has a wide assortment of control options. Dusk to dawn controls include MVOLT and 347V button-type photocells and NEMA twist-lock photocell receptacles.

nLIGHT AIR CONTROLS

The RSX LED area luminaire is also available with nLight® AIR for the ultimate in wireless control. This powerful controls platform provides out-of-the-box basic motion sensing with photocontrol functionality and is suitable for mounting heights up to 40 feet. No commissioning is required when using factory default settings that provide basic stand-alone motion occupancy dimming that is switched on and off with a built-in photocell. See chart above for motion sensor default out-of-box settings. For more advanced wireless functionality, such as group dimming, nLight AIR can be commissioned using a smartphone and the easy-to-use CLAIRITY app. nLight AIR equipped luminaires can be grouped, resulting in motion sensor and photocell group response without the need for additional equipment. Scheduled dimming with motion sensor over-ride can be achieved when used with the nLight Eclipse. Additional information about nLight Air can be found [here](#).

INSTALLATION

Integral "no-drill" mounting arm allows for fast, easy mounting using existing pole drillings. Select the "SPA" option for square poles and the "RPA" option to mount to round poles. Note, the RPA mount can also be used for mounting to square poles by omitting the RPA adapter plate. Select the "MA" option to attach the luminaire to a 2 3/8" horizontal mast arm or the "IS" option for an adjustable slipfitter that mounts on a 2 3/8" OD tenon. The adjustable slipfitter has an integral junction box and offers easy installation. Can be tilted up to 90° above horizontal. Additional mountings are available including a wall bracket, adjustable tilt arm for direct-to-pole and wall and a surface conduit box for wall mount applications.

LISTINGS

CSA Certified to meet U.S. and Canadian standards. Suitable for wet locations. Rated for -40°C minimum ambient. DesignLights Consortium® (DLC) Premium qualified product and DLC qualified product. Not all versions of this product may be DLC Premium qualified or DLC qualified. Please check the DLC Qualified Products List at www.designlights.org/QPL to confirm which versions are qualified.

International Dark-Sky Association (IDA) Fixture Seal of Approval (FSA) is available for all products on this page utilizing 3000K color temperature only. US Patent No. D882, 146S

GOVERNMENT PROCUREMENT

BAA – Buy America(n) Act: Product with the BAA option qualifies as a domestic end product under the Buy American Act as implemented in the FAR and DFARS. Product with the BAA option also qualifies as manufactured in the United States under DOT Buy America regulations. BABA – Build America Buy America: Product with the BAA option also qualifies as produced in the United States under the definitions of the Build America, Buy America Act. Please refer to www.acuitybrands.com/buy-american for additional information.

WARRANTY

5-year limited warranty. This is the only warranty provided and no other statements in this specification sheet create any warranty of any kind. All other express and implied warranties are disclaimed. Complete warranty terms located at: www.acuitybrands.com/support/warranty/terms-and-conditions

Note: Actual performance may differ as a result of end-user environment and application. All values are design or typical values, measured under laboratory conditions at 25 °C. Specifications subject to change without notice.

