



**LOW PROFILE 4" APERTURE  
UP TO 4800 LUMENS DELIVERED  
LLP4/LLPRM4 SERIES**

Type	Cat. No.
_____	_____
Project: _____	
Notes: _____	

**Extreme Low Profile with No Compromises**

- 3000 lumens delivered with as low as 2" plenum space\*
- 4800 lumens delivered with as low as 3" plenum space\*
- Maintains same 45° cut-off as the standard L-Series fixtures
- Patented Hyperbolic (U.S. Patent No. 10,670,227 B2), Parabolic, and Wall Washer (single, double and corner) distributions
- Patented mechanical design (U.S. Patent No. 10,724,717 B2)
- New Construction, Remodel, and Chicago Plenum versions
- Chicago Plenum is IC rated for 08LM – 23LM
- Flanged and flangeless
- **Low UGR:** UGR of zero for fixtures aimed at nadir with a cut-off equal to or less than 60deg per CIE 117-1995 Discomfort Glare in Interior Lighting.



**A+** Capable options indicated by this color background

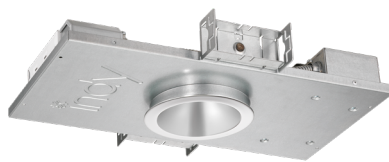

**NEW CONSTRUCTION**



**REMODEL**

**As low as 2" \***

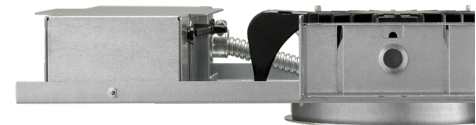

\* Fixture height may vary. See dimensional drawings for details.

**ORDERING INFORMATION - COMPLETE FIXTURE**

Complete Fixture Catalog# Example: LLP4 08LM 35K MVOLT G4 80CRI ZT HM CD HBTL

Series	Light Engine	CCT	Voltage	Gen	CRI	Driver	Rough-In Options
LLP4	4" L-Series Low Profile New Construction Downlight	08LM 13LM 15LM	27K 30K 35K	120 277 347	G4	80CRI 90CRI 97CRI <sup>1</sup>	F2.5 Fuse and Fuse Holder CP <sup>2,3,6,11,13</sup> Chicago Plenum rated; IC rated up to 23LM
	LLPRM4 <sup>2,8,14,17</sup>	4" L-Series Low Profile Remodel Downlight	17LM 23LM 28LM 33LM 40LM 45LM	40K 50K		MVOLT (120-277)	EZ10 eldoLED 0-10V ECOdrive. Linear dimming to 10% min. EZ1 eldoLED 0-10V ECOdrive. Linear dimming to 1% min. EZB eldoLED 0-10V SOLOdrive. Logarithmic dimming to <1% FD <sup>3,4</sup> Forward or Reverse Phase Dimming Driver ECOD <sup>3,16</sup> Lutron Ecosystem Dimming Driver GZ1 0-10V Dimming to 1% min ZT 0-10V Dimming to 10% min

Trim Style	Finish	Trim Options	Mounting
HM Hyperbolic Medium	BD Black Diffuse	PF <sup>10</sup> White Flange	Blank Flanged
HW Hyperbolic Wide	BS Black Specular	WET <sup>6,7</sup> Wet Location	FM <sup>9</sup> Flangeless, drywall ceilings only
HWS Hyperbolic Single Wall Wash	CD Clear Diffuse		
P Parabolic Medium	CS Clear Specular		
	CSS Clear Semi-Specular		
	GD Gold Diffuse		
	GS Gold Specular		
	PTD Pewter Diffuse		
	PTD Pewter Specular		
	WH White, White Flange		
	WTD Wheat Diffuse		
	WTS Wheat Specular		

Accessories <sup>11</sup>	
IFMA4 <sup>9,11</sup>	4" Flangeless Adapter for Drywall Ceilings Only
HB28 <sup>11</sup>	28" C-Channel Bar Hangers, Pair
HB52 <sup>11</sup>	52" C-Channel Bar Hangers, Pair
HBTL <sup>11</sup>	25" Tru-Lock Grid Ceiling Bar Hanger, Pair
LB27 <sup>11</sup>	27" Linear Bar Hangers, Pair

**Ordering Notes**

- 1 2700K & 3000K only.
- 2 Not available with 347V.
- 3 Not available for NL, NLER, NLTAIR2, NLTAIRER2.
- 4 120V only. Not available with 40LM.
- 5 Specify voltage.
- 6 Not compatible with BR, BRT20C, HBR, HBRT20C.
- 7 Compatible with Parabolic trim styles only.
- 8 Not compatible with FM.
- 9 IFMA4 required for FM.
- 10 PF not available with WH finish. When specifying WH finish, flange is always painted white.
- 11 Not compatible with LLPRM4.
- 12 Not recommended for metal ceilings.
- 13 For 28LM - 45LM, specify voltage. Not available with ZT or GZ1 for 40LM and 45LM. Not available with NLTAIR2 or NLTAIRER2.
- 14 LLPRM4 with NL or NLER options must be ordered with EZ1, EZB, or EZ10 drivers.
- 15 WPR available with CS, CSS, CD, WH finishes only.
- 16 Not compatible with LLPRM4 at 45LM. Not compatible with CP for 28LM and up.
- 17 LLPRM4 with NLTAIR2 or NLTAIRER2 requires 3" minimum plenum height.

## PERFORMANCE

LIGHT ENGINE	08LM		13LM		15LM		17LM		23LM		28LM		33LM		40LM		45LM	
	120V	277V	120V	277V	120V	277V	120V	277V	120V	277V	120V	277V	120V	277V	120V	277V	120V	277V
VOLTAGE	120V	277V	120V	277V	120V	277V	120V	277V	120V	277V	120V	277V	120V	277V	120V	277V	120V	277V
INPUT WATTS	7.5	7.9	11.7	11.8	13.7	13.8	17.8	17.9	23.5	23.7	28.5	28.2	33.6	33.8	42.1	41.7	41.4	41.7
INPUT CURRENT	0.06	0.31	0.10	0.05	0.12	0.06	0.15	0.07	0.20	0.09	0.24	0.11	0.28	0.13	0.35	0.16	0.35	0.16
POWER FACTOR	0.99	0.90	0.99	0.89	0.99	0.89	0.99	0.91	0.99	0.92	1.00	0.94	1.00	0.93	1.00	0.95	1.00	0.93
THD %	6.4	12.0	5.2	11.6	4.6	11.3	3.9	11.3	5.1	9.9	5.5	9.0	4.4	10.5	4.5	8.8	6.0	9.2
<b>HYPERBOLIC REFLECTOR: LLP4 HW CS (35K 80CRI)</b>																		
DELIVERED LUMENS (LLP4 HW CS)	866		1,445		1,670		1,901		2,559		3,086		3,591		4,366		4,879	
EFFICACY (LPW)	115		123		122		107		109		108		107		104		118	
<b>PARABOLIC REFLECTOR: LLP4 P CS (35K 80CRI)</b>																		
DELIVERED LUMENS (LLP4 P CS)	658		1,097		1,268		1,444		1,943		2,343		2,727		3,315		3,705	
EFFICACY (LPW)	87		94		93		81		83		82		81		79		90	

## OPTICAL DISTRIBUTIONS

HYPERBOLIC BEAM SPREAD		
Trim	08LM - 33LM	40LM-45LM
LLP4 HM CS	37°	52°
LLP4 HM CSS	37°	52°
LLP4 HM CD	45°	58°
LLP4 HW CS	55°	64°
LLP4 HW CSS	55°	64°
LLP4 HW CD	65°	69°

PARABOLIC BEAM SPREAD		
Trim	08LM - 33LM	40LM - 45LM
LLP4 P CS	65°	67°
LLP4 P CSS	65°	71°
LLP4 P CD	69°	73°
LLP4 WPR CS	75°	78°
LLP4 WPR CSS	77°	79°
LLP4 WPR CD	79°	80°

## LUMEN MULTIPLIERS

CCT	MULTIPLIER
2700K	0.90
3000K	0.96
3500K	1.00
4000K	1.02
5000K	1.04

CRI	MULTIPLIER
80CRI	1.00
90CRI	0.83
97CRI	0.77

HYPERBOLIC TRIM	MULTIPLIER
LLP4 HM CS	0.99
LLP4 HM CSS	0.97
LLP4 HM CD	0.91
LLP4 HW CS	1.00
LLP4 HW CSS	0.96
LLP4 HW CD	0.90

PARABOLIC TRIM	MULTIPLIER
LLP4 P CS	1.00
LLP4 P CSS	0.93
LLP4 P CD	0.94
LLP4 WPR CS	0.93
LLP4 WPR CSS	0.91
LLP4 WPR CD	0.88

Applying Lumen Multipliers to Calculate Delivered Lumens								
Base Fixture Delivered Lumens (from Performance Table)	x	CCT Multiplier	x	CRI Multiplier	x	Trim Multiplier	=	Delivered Lumens for Desired Fixture and Reflector
<b>Example: LLP4 23LM 30K MVOLT 90CRI G4 ZT HM CD</b>								
2559 Lumens	x	0.96	x	0.83	x	0.91	=	1886 Lumens

## PRODUCT SPECIFICATIONS

### OPTICS

**Hyperbolic:** Patented hyperbolic shape (U.S. Patent No. 10,670,227 B2) optimized for small, directional LED source, maximizes fixture efficiency while creating the "Silent Ceiling" appearance by reducing lamp image and aperture brightness • Geometry of hyperbolic curve provides unique aperture appearance and smoother light distribution

**Parabolic/Lens:** Computer-optimized parabolic reflector with frosted convex lens regressed into cone provides uniform distribution with no striations

**Wall Wash:** Available in Hyperbolic and Parabolic. Both providing uniform distributions with no striations

### ELECTRICAL

**LED Light Engine:** Compact light source delivers uniform illumination without pixilation, enabling excellent beam control • 2SDCM (5000K within 3SDCM) • 80, 90 & 97 CRI • Replaceable light engine with push in wire connections

**Passive Cooling:** Aluminum heat sink integrated directly with housing provides superior thermal management to ensure the long life of LED

**LED Driver:** Power factor >0.9 • Easily replaceable from above or below the ceiling

**Dimming:** Dimmable via 0-10V protocol standard • Optional drivers available for use with eldoLED, Lutron EcoSystem, 2-wire dimmers, or DALI • For a list of compatible dimmers, see [LED-DIM](#).

**Life:** Rated for 60,000 hours at 70% lumen maintenance

**Emergency Battery Pack (Optional) output:** Provides a minimum of 600 (BR & BRT20C), or 1000 (HBR & HBRT20C) lumens for a minimum duration of 90 minutes • BRT20C, HBRT20C options are CEC Title 20 compliant • All battery packs are remote mounted. Installation and maintenance require above ceiling access.

### MECHANICAL

**New Construction Housing:** Patented shallow plenum design (U.S. Patent No. 10,724,717 B2), universal housing installs in suspended grid, plaster or drywall • Integral heat sink conducts heat away from LED light engine • Driver is accessible from above and below ceiling and can be upgraded to accommodate future technology improvements

**Mounting Frame:** Heavy gauge steel lower housing ring accommodates ceilings up to 2" thick

**Mounting Bracket:** New Construction mounting brackets have vertical adjustment (no adjustment on Chicago Plenum option) and accepts most commercial bar hangers, including our proprietary Tru-Lock bar hangers • Our one-piece Tru-Lock bar hangers have integral T-bar locking screws and alignment notches for locating and locking fixture in the center or 1/4" tile increments

**Junction Box:** 3" x 8" galvanized steel junction box with (3) 1/2" knockouts facilitate quick wiring • New Construction junction box rated for four (4) No. 12 AWG 90° C branch circuit conductors (2-in, 2-out)

**Flangeless Adapter:** Must specify IFMA4 when flangeless, "FM" option, is specified. Suitable for drywall installation only.

**Remodel Housing:** Patented design (U.S. Patent No. 10,724,717 B2), housing installs from below ceiling in applications where above ceiling access is not available • Not suitable for installation in T-grid ceilings

• Remodel springs accommodate ceilings from 5/8" to 1-1/8" thick  
• Integral heat sink conducts heat away from LED light engine • Driver is accessible from below the ceiling and can be upgraded to accommodate future technology improvements.

**Remodel Junction Box:** 2.75" x 4.5" galvanized steel junction box with (8) 1/2" knockouts facilitate quick wiring

### LABELS AND LISTINGS

Tested to UL1598 and CSA C22.2 250 listed for feed through and damp location • Chicago Plenum version is IC rated for 08LM – 23LM (no spray foam insulation) • RoHS compliant • EMI complies with FCC 47, Part 15, Class A • ENERGY STAR® certified, see table for designated products • I.B.E.W. Union made

**BUY AMERICAN ACT:** This product is assembled in the USA and meets the Buy America(n) government procurement requirements under FAR, DFARS and DOT regulations. Please refer to [www.acuitybrands.com/buy-american](http://www.acuitybrands.com/buy-american) for additional information.

**Warranty:** 5 years when used in accordance with manufacturing guidelines. This is the only warranty provided and no other statements in this specification sheet create any warranty of any kind. All other express and implied warranties are disclaimed.

**Note:** Actual performance may differ as a result of end-user environment and application.



Specifications subject to change without notice.

## ENERGY STAR® certified

ENERGY STAR® certified		PRODUCT#		FIXTURE CONFIGURATIONS = ENERGY STAR	
	(S) (WW)LM (XX)K (V) G4 (YY)CRI (UU) (ZZ) (CC)	Series:	S = LLP4	Lumen Package:	WW = 08, 13, 15, 17, 23, 28, 33, 40, 45
		CCT:	XX = 27, 30, 35, 40, 50	Voltage:	V = MVOLT, 120, 277
		CRI:	YY = 80, 90, 97	Driver:	UU = FD, EZ1, EZ10, EZB, ZI, GZ1
		Trim Type:	ZZ = HM, HW, P, WPR	Trim Color/Finish:	CC = CS, CSS, CD
		Option:	* = AE2CD		

**ORDERING INFORMATION - INDIVIDUAL COMPONENTS** (Use when ordering rough-in and LED Trim Module separately)

**Rough-In Only**

Series	Light Engine	Voltage	Gen	Driver	Rough-In Options
<b>LLP4</b> New Construction Rough-In  <b>LLPRM4</b> <sup>2,8,14,17</sup> Remodel Rough-In 	<b>08LM</b> <b>13LM</b> <b>15LM</b> <b>17LM</b> <b>23LM</b> <b>28LM</b> <b>33LM</b> <b>40LM</b> <b>45LM</b>	<b>120</b> <b>277</b> <b>347</b> <b>MVOLT</b> <b>(120-277)</b>	<b>G4</b>	<b>EDAB</b> <sup>3</sup> eldoLED SOLOdrive DALI. Logarithmic dimming to <1% eldoLED 0-10V ECOdrive. Linear dimming to 10% min. <b>EZ10</b> eldoLED 0-10V ECOdrive. Linear dimming to 10% min. <b>EZ1</b> eldoLED 0-10V ECOdrive. Linear dimming to 1% min. <b>EZB</b> eldoLED 0-10V SOLOdrive. Logarithmic dimming to <1% <b>FD</b> <sup>3,4</sup> Forward or Reverse Phase Dimming Driver <b>ECOD</b> <sup>3,16</sup> Lutron Ecosystem Dimming Driver <b>GZ1</b> 0-10V Dimming to 1% min <b>ZT</b> 0-10V Dimming to 10% min	<b>F</b> <sup>2,5</sup> Fuse and Fuse Holder <b>CP</b> <sup>3,6,11,13</sup> Chicago Plenum rated; IC rated up to 23LM <b>BR</b> <sup>2,11</sup> 600 Lumen Emergency Battery Pack <b>BRT20C</b> <sup>2,11</sup> 600 Lumen Emergency Battery Pack, Title 20 Compliant <b>HBR</b> <sup>2,11</sup> 1000 Lumen Emergency Battery Pack <b>HBRT20C</b> <sup>2,11</sup> 1000 Lumen Emergency Battery Pack, Title 20 Compliant <b>NL</b> <sup>5,14</sup> nLight® Dimming Pack Controls <b>NLER</b> <sup>5,14</sup> nLight® dimming pack controls. nLER controls fixtures on emergency circuit <b>NLTAIR2</b> <sup>2,12,17</sup> nLight® AIR Dimming Pack Wireless Controls <b>NLTAIRER2</b> <sup>2,12,17</sup> nLight® AIR Dimming Pack Wireless Controls. Controls fixtures on emergency circuit

**LED Trim Module Only - Includes Reflector**

Series	Light Engine	CCT	Gen	CRI	Options	Trim Style	Finish	Trim Option	Mounting
<b>LLP4</b> Trim & Module (Includes Reflector) 	<b>08LM</b> <b>13LM</b> <b>15LM</b> <b>17LM</b> <b>23LM</b> <b>28LM</b> <b>33LM</b> <b>40LM</b> <b>45LM</b>	<b>27K</b> <b>30K</b> <b>35K</b> <b>40K</b> <b>50K</b>	<b>G4</b>	<b>80CRI</b> <b>90CRI</b> <b>97CRI</b> <sup>1</sup>	<b>CP</b> <sup>6,11,13</sup> Chicago Plenum	<b>HM</b> Hyperbolic Medium <b>HW</b> Hyperbolic Wide <b>HWS</b> Hyperbolic Single Wall Wash <b>P</b> Parabolic Medium <b>WPR</b> <sup>8,15</sup> Parabolic Wide <b>WC</b> Corner Wall Wash <b>WD</b> Double Wall Wash <b>WS</b> Single Wall Wash	<b>BD</b> Black Diffuse <b>BS</b> Black Specular <b>BZD</b> Bronze Diffuse <b>BZS</b> Bronze Specular <b>CD</b> Clear Diffuse <b>CS</b> Clear Specular <b>CSS</b> Clear Semi-Specular <b>GD</b> Gold Diffuse <b>GS</b> Gold Specular <b>PTD</b> Pewter Diffuse <b>PTS</b> Pewter Specular <b>WH</b> White, White Flange <b>WTD</b> Wheat Diffuse <b>WTS</b> Wheat Specular	<b>PF</b> <sup>10</sup> White Flange <b>WET</b> <sup>6,7</sup> Wet Location	<b>Blank</b> Flanged <b>FM</b> <sup>9</sup> Flangeless, drywall ceilings only

**ORDERING INFORMATION - REPLACEMENT PARTS**

**Replacement Reflector Only**

Series	Trim Style	Finish	Trim Option	Mounting
<b>LLP4</b> Low Profile Reflector only 	<b>HM</b> Hyperbolic Medium <b>HW</b> Hyperbolic Wide <b>HWS</b> Hyperbolic Single Wall Wash <b>P</b> Parabolic Medium <b>WPR</b> <sup>8,15</sup> Parabolic Wide <b>WC</b> Corner Wall Wash <b>WD</b> Double Wall Wash <b>WS</b> Single Wall Wash	<b>BD</b> Black Diffuse <b>BS</b> Black Specular <b>BZD</b> Bronze Diffuse <b>BZS</b> Bronze Specular <b>CD</b> Clear Diffuse <b>CS</b> Clear Specular <b>CSS</b> Clear Semi-Specular <b>GD</b> Gold Diffuse <b>GS</b> Gold Specular <b>PTD</b> Pewter Diffuse <b>PTS</b> Pewter Specular <b>WH</b> White, White Flange <b>WTD</b> Wheat Diffuse <b>WTS</b> Wheat Specular	<b>PF</b> <sup>10</sup> White Flange <b>WET</b> <sup>6,7</sup> Wet Location	<b>Blank</b> Flanged <b>FM</b> <sup>9</sup> Flangeless, drywall ceilings only

**Ordering Notes**

- 2700K & 3000K only.
- Not available with 347V.
- Not available for NL, NLER, NLTAIR2, NLTAIRER2.
- 120V only. Not available with 40LM.
- Specify voltage.
- Not compatible with BR, BRT20C, HBR, HBRT20C.
- Compatible with Parabolic trim styles only.
- Not compatible with FM.
- IFMA4 required for FM.
- PF not available with WH finish. When specifying WH finish, flange is always painted white.
- Not compatible with LLPRM4.
- Not recommended for metal ceilings.
- For 28LM - 45LM, specify voltage. Not available with ZT or GZ1 for 40LM and 45LM. Not available with NLTAIR2 or NLTAIRER2.
- LLPRM4 with NL or NLER options must be ordered with EZ1, EZB, or EZ10 drivers.
- WPR available with CS, CSS, CD, WH finishes only.
- Not compatible with LLPRM4 at 45LM. Not compatible with CP for 28LM and up.
- LLPRM4 with NLTAIR2 or NLTAIRER2 requires 3" minimum plenum height.

# DIMENSIONAL DRAWINGS

**TRIMS:**

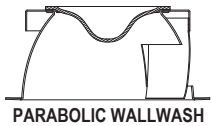
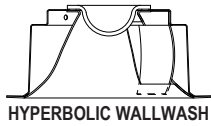
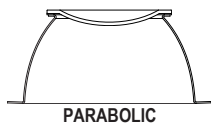
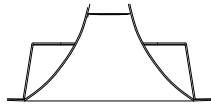

APERTURE: 4-1/4" Dia.  
 CEILING CUTOUT: 5" Dia.  
 OVERLAP TRIM: 5-1/2" Dia.

**NEW CONSTRUCTION**

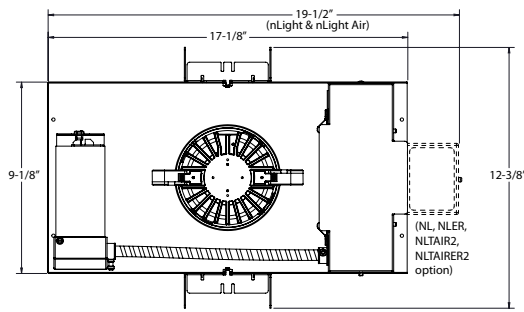

**NEW CONSTRUCTION – CHICAGO PLENUM**

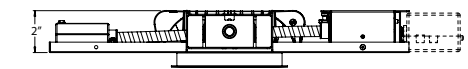
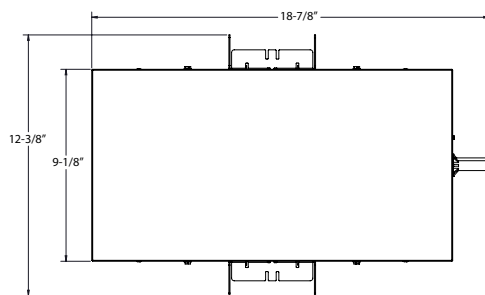

Up to 28LM

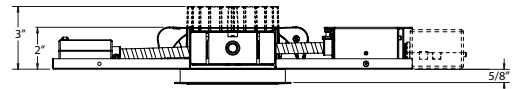

33LM or higher

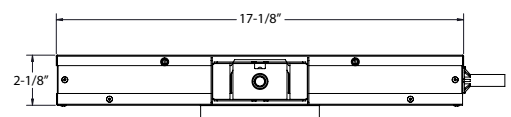

Up to 28LM

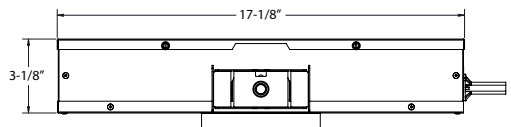

33LM or higher

**REMODEL**

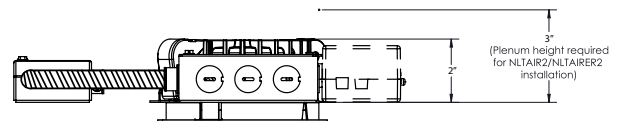
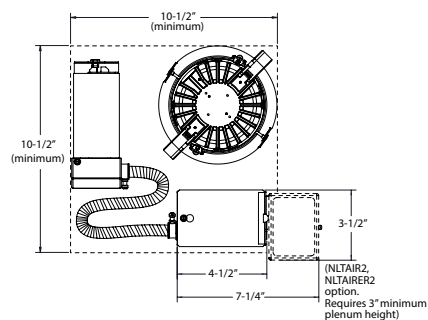

Up to 28LM

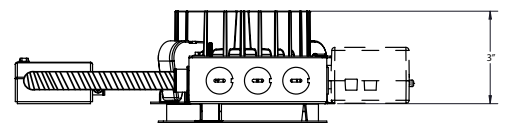

33LM or higher

HYPERBOLIC PHOTOMETRICS

Distribution Curve      Distribution Data      Zonal Lumens      Coefficient of Utilization      Illuminance Data at 30" Above Floor for a Single Luminaire

LLP4 13LM 35K + LLP4 HM CS, 3500K LEDs, input watts: 11.74, delivered lumens: 1412.5, LM/W = 120.3, Spacing Criteria: 0.6, test no. PR07172482, tested in accordance to IESNA LM-79.

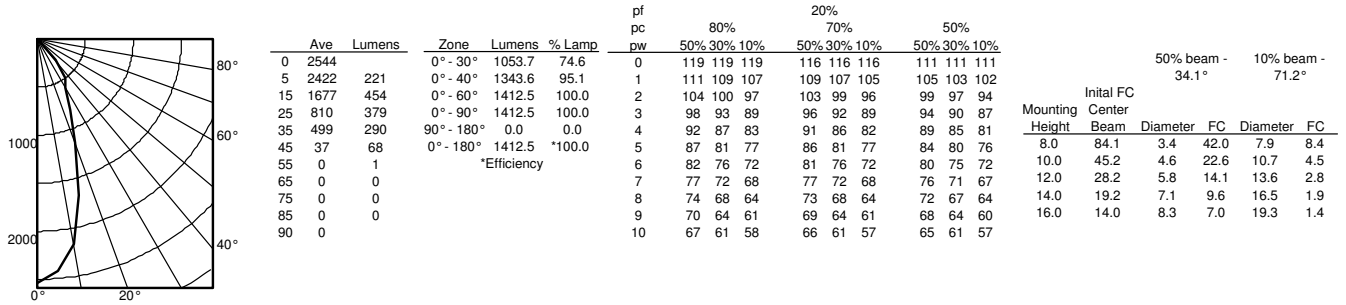

LLP4 13LM 35K + LLP4 HW CS, 3500K LEDs, input watts: 11.74, delivered lumens: 1447.9, LM/W = 123.3, Spacing Criteria: 0.8, test no. PR07172483, tested in accordance to IESNA LM-79.

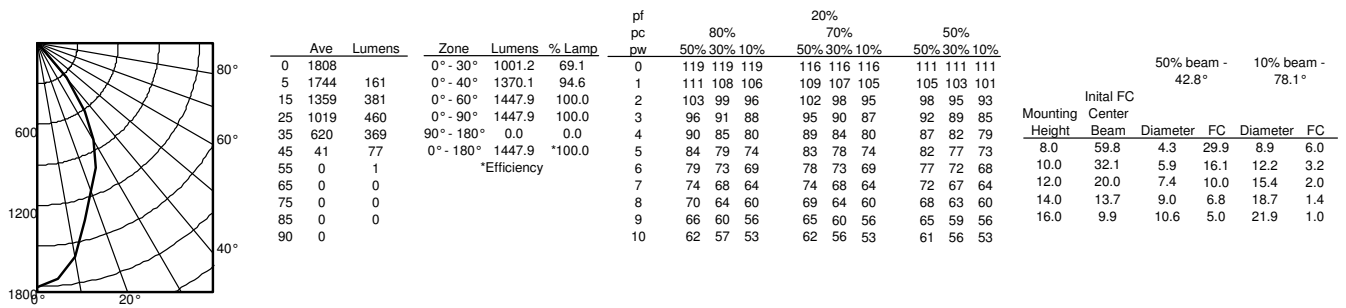

**HYPERBOLIC PHOTOMETRICS**

**Distribution Curve      Distribution Data      Zonal Lumens      Coefficient of Utilization      Illuminance Data at 30" Above Floor for a Single Luminaire**

**LLP4 45LM 35K + LLP4 HM CS, 3500K LEDs, input watts: 41.41, delivered lumens: 4792.6, LM/W = 115.7, Spacing Criteria: 0.8, test no. PR07172582, tested in accordance to IESNA LM-79.**

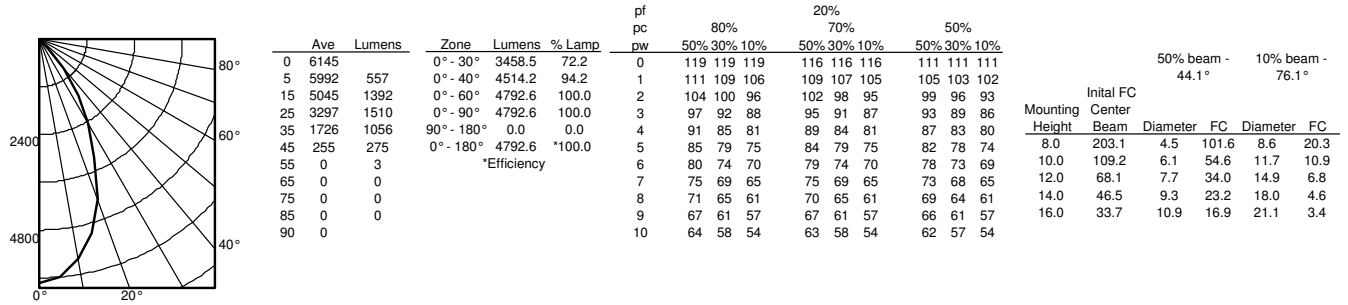

**LLP4 45LM 35K + LLP4 HW CS, 3500K LEDs, input watts: 41.41, delivered lumens: 4858.7, LM/W = 117.3, Spacing Criteria: 1.0, test no. PR07172583, tested in accordance to IESNA LM-79.**

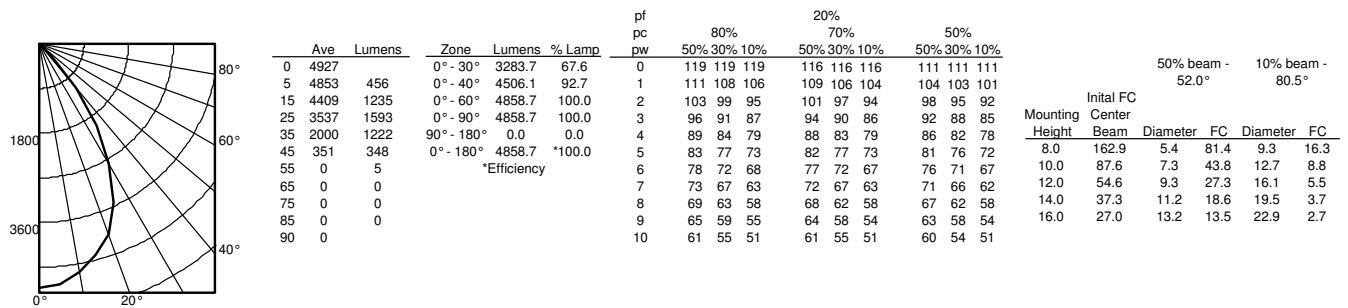

PARABOLIC PHOTOMETRICS

Distribution Curve      Distribution Data      Zonal Lumens      Coefficient of Utilization      Illuminance Data at 30" Above Floor for a Single Luminaire

LLP4 13LM 35K + LLP4 P CS, 3500K LEDs, input watts: 11.74, delivered lumens: 1088.2, LM/W = 92.7, Spacing Criteria: 1.0, test no. PR07172484, tested in accordance to IESNA LM-79.

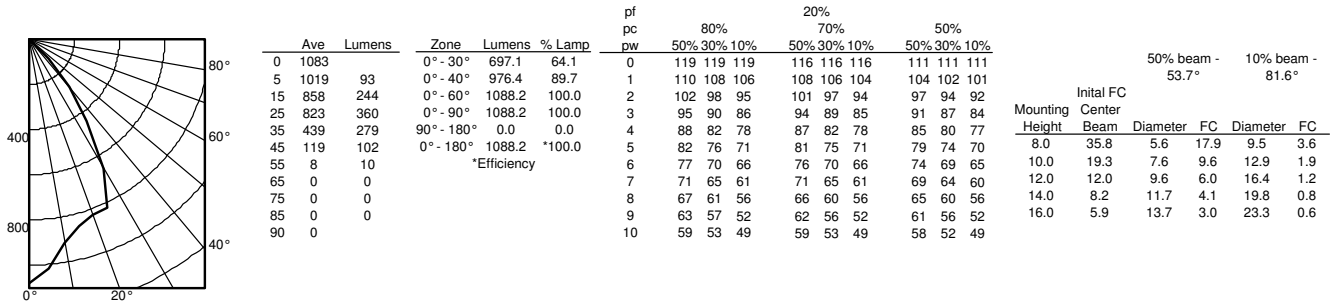

LLP4 45LM 35K + LLP4 P CS, 3500K LEDs, input watts: 41.41, delivered lumens: 3663.3, LM/W = 88.5, Spacing Criteria: 1.0, test no. PR07172584, tested in accordance to IESNA LM-79.

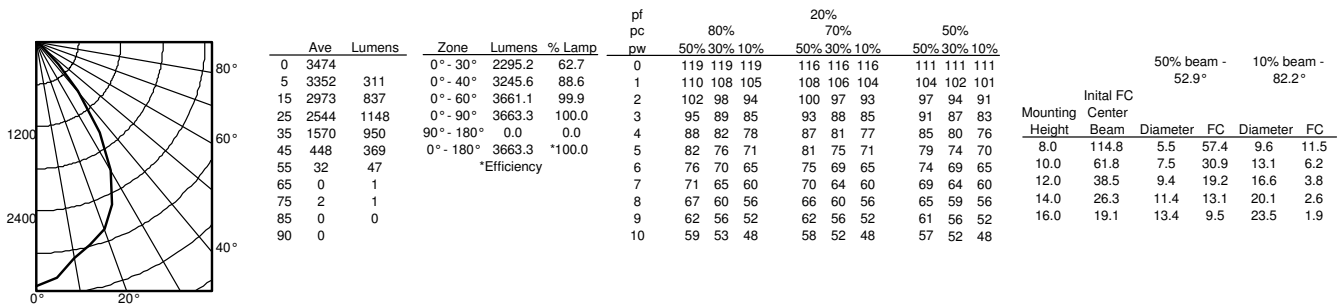

LLP4 45LM 35K + LLP4 WPR CS, 3500K LEDs, input watts: 41.41, delivered lumens: 3385, LM/W = 81.7, Spacing Criteria: 1.0, test no. PR11170694P, tested in accordance to IESNA LM-79.

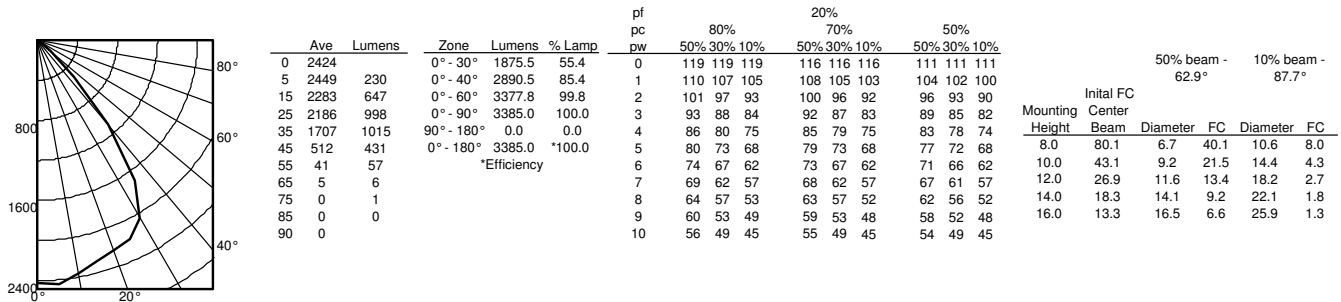



**PERFORMANCE DATA****LUMINAIRES SPACED 2' FROM WALL**

Catalog Number: LLP4 40LM 35K 120 G4 80CRI ZT; LLP4 HWS CD Spread: Single Wall Test #: PR07172691

Single Unit						Lamp	Multiple Units On 2' Centers*			Multiple Units On 3' Centers*			Multiple Units On 4' Centers*		
Lateral Distance From Fixture 2' From Wall						BXRC-35E4000- D-73-SE	Spaced 2' From Wall			Spaced 2' From Wall			Spaced 2' From Wall		
0'	1'	2'	3'	4'	5'	Distance From Ceiling	CL	CL	CL	CL	CL	CL	CL	CL	
55	39	17	6	3	3	1'	90	87	90	66	56	66	59	34	59
69	54	27	11	5	4	2'	126	126	126	88	84	88	76	55	76
54	42	24	12	6	4	3'	106	104	106	75	71	75	63	49	63
39	34	23	12	7	5	4'	89	89	89	62	62	62	48	46	48
27	24	19	13	8	5	5'	71	71	71	50	50	50	38	39	38
19	17	15	12	8	6	6'	57	57	57	41	41	41	32	32	32
14	13	12	10	8	6	7'	47	47	47	34	35	34	27	27	27
11	11	10	8	7	6	8'	39	39	39	29	30	29	23	22	23
8	8	7	6	6	5	9'	30	31	30	23	24	23	18	18	18
6	6	5	5	5	4	10'	22	22	22	18	18	18	13	13	13

**LUMINAIRES SPACED 3' FROM WALL**

Catalog Number: LLP4 40LM 35K 120 G4 80CRI ZT; LLP4 HWS CD Spread: Single Wall Test #: PR07172691

Single Unit						Lamp	Multiple Units On 3' Centers*			Multiple Units On 4' Centers*			Multiple Units On 5' Centers*		
Lateral Distance From Fixture 3' From Wall						BXRC-35E4000- D-73-SE	Spaced 3' From Wall			Spaced 3' From Wall			Spaced 3' From Wall		
0'	1'	2'	3'	4'	5'	Distance From Ceiling	CL	CL	CL	CL	CL	CL	CL	CL	
21	17	11	7	4	3	1'	32	32	32	26	24	26	23	17	23
37	32	21	13	7	5	2'	62	61	62	49	46	49	42	33	42
32	29	22	14	9	6	3'	60	60	60	46	46	46	39	35	39
28	25	19	13	9	6	4'	53	52	53	42	40	42	35	32	35
24	22	17	13	9	6	5'	48	49	48	38	38	38	31	30	31
20	18	16	12	9	7	6'	43	43	43	34	35	34	28	28	28
16	15	13	11	9	7	7'	39	39	39	30	30	30	25	25	25
12	12	11	10	8	7	8'	33	34	33	26	27	26	22	21	22
10	9	8	8	7	6	9'	27	28	27	22	22	22	18	17	18
7	7	7	6	5	5	10'	22	22	22	18	18	18	14	14	14

\*Based on minimum of five luminaires. Reflectances: 80, 50, 20. Values are rounded to nearest whole footcandle.

Fixtures tested to IES recommended standard for solid state lighting per LM-79-08. Photometric performance on a single unit represents a baseline of performance for the fixture. Results may vary in the field.

**PERFORMANCE DATA****LUMINAIRES SPACED 2' FROM WALL**

Catalog Number: LLP4 40LM 35K 120 G4 80CRI ZT; LLP4 WS CSS Spread: Single Wall Test #: PRO7172692

Single Unit						Lamp	Multiple Units On 2' Centers*			Multiple Units On 3' Centers*			Multiple Units On 4' Centers*		
Lateral Distance From Fixture 2' From Wall						BXRC-35E4000- D-73-SE	Spaced 2' From Wall			Spaced 2' From Wall			Spaced 2' From Wall		
0'	1'	2'	3'	4'	5'	Distance From Ceiling	CL	CL	CL	CL	CL	CL	CL	CL	
27	17	7	4	3	3	1'	42	38	42	34	23	34	32	14	32
60	37	14	7	5	4	2'	89	84	89	72	50	72	66	29	66
67	51	24	10	6	5	3'	119	119	119	85	79	85	76	49	76
41	38	27	14	7	5	4'	99	99	99	67	72	67	52	54	52
26	25	21	14	9	6	5'	77	78	77	55	55	55	41	44	41
19	18	16	13	10	7	6'	62	62	62	45	46	45	35	35	35
15	14	13	11	9	7	7'	51	51	51	38	39	38	30	30	30
12	11	10	9	8	7	8'	43	43	43	32	33	32	25	24	25
9	9	8	7	6	6	9'	33	34	33	26	27	26	20	20	20
6	6	6	5	5	4	10'	24	24	24	20	20	20	15	15	15

**LUMINAIRES SPACED 3' FROM WALL**

Catalog Number: LLP4 40LM 35K 120 G4 80CRI ZT; LLP4 WS CSS Spread: Single Wall Test #: PRO7172692

Single Unit						Lamp	Multiple Units On 3' Centers*			Multiple Units On 4' Centers*			Multiple Units On 5' Centers*		
Lateral Distance From Fixture 3' From Wall						BXRC-35E4000- D-73-SE	Spaced 3' From Wall			Spaced 3' From Wall			Spaced 3' From Wall		
0'	1'	2'	3'	4'	5'	Distance From Ceiling	CL	CL	CL	CL	CL	CL	CL	CL	
12	9	6	4	3	3	1'	18	17	18	16	13	16	15	8	15
21	16	10	6	5	5	2'	32	30	32	28	22	28	25	14	25
32	25	15	9	6	5	3'	48	45	48	41	32	41	37	21	37
36	31	21	12	8	6	4'	58	58	58	47	44	47	41	31	41
27	26	21	14	9	7	5'	55	55	55	42	44	42	35	35	35
20	20	17	14	11	8	6'	49	49	49	37	39	37	30	32	30
16	16	14	13	11	9	7'	42	43	42	33	34	33	27	27	27
13	13	12	11	9	8	8'	37	38	37	29	30	29	24	23	24
10	10	9	9	8	7	9'	30	32	30	24	25	24	20	19	20
8	7	7	6	6	6	10'	24	24	24	19	19	19	16	16	16

\*Based on minimum of five luminaires. Reflectances: 80, 50, 20. Values are rounded to nearest whole footcandle.

Fixtures tested to IES recommended standard for solid state lighting per LM-79-08. Photometric performance on a single unit represents a baseline of performance for the fixture. Results may vary in the field.

**CONTROLS**

**EXAMPLE**

Group Fixture Control\*

\*Application diagram applies for fixtures with eldoLED drivers only.

- nPS 80 EZ** Dimming/Control Pack (qty: 2 required)
- nPODM 2P DX** Dual On/Off/Dim Push-Button WallPod
- nCM ADCX** Daylight Sensor with Automatic Dimming Control
- nCM PDT 9** Dual Technology Occupancy Sensor

**Description:** This design provides a dual on/off/dim wall station that enables manual control of the fixtures in Row A and Row B separately. Additionally, a daylight harvesting sensor is provided so the lights in Row B can be configured to dim automatically when daylight is available. An occupancy sensor turns off all lights when the space is vacant.

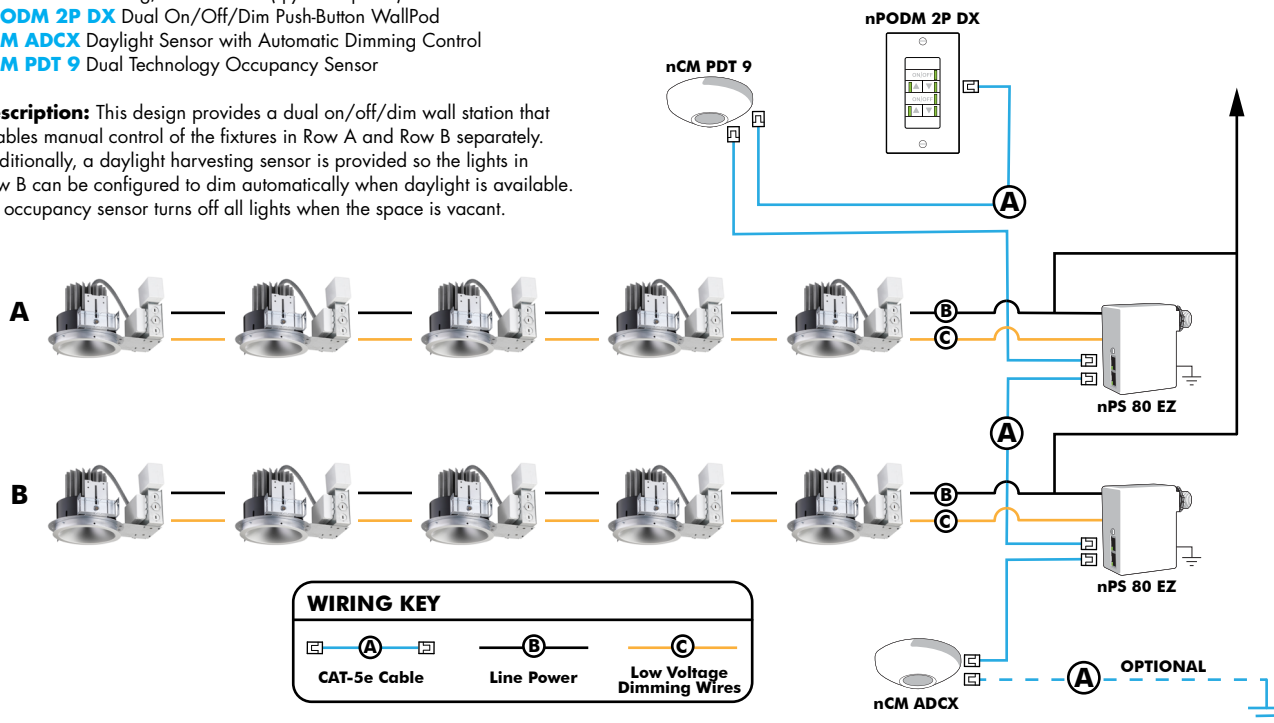

**Choose Wall Controls**

nLight offers multiple styles of wall controls - each with varying features and user experience.



**Push-Button Wallpod**  
Traditional tactile buttons and LED user feedback

**Graphic Wallpod**  
Full color touch screen provides a sophisticated look and feel

**nLight® Controls Accessories:**

Order as separate catalog number. Visit [www.sensorswitch.com/nLight](http://www.sensorswitch.com/nLight) for complete listing of nLight controls.

WallPod Stations	Model number	Occupancy sensors	Model Number
On/Off	nPODM (Color)	Small motion 360°, ceiling (PIR/dual Tech)	nCM 9 / nCM PDT 9
On/Off & Raise/Lower	nPOD DX (Color)	Large motion 360°, ceiling (PIR/dual tech)	nCM 10 / nCM PDT 10
Graphic Touchscreen	nPOD GFX (Color)	Wide View (PIR/dual tech)	nWV 16 / nWV PDT 16
<b>Photocell controls</b>	<b>Model Number</b>	Wall Switch w/ Raise/Lower (PIR/dual tech)	nWSX LV DX / nWSX PDT LV DX
Dimming	nCM ADCX	<b>Cat-5 cables (plenum rated)</b>	<b>Model Number</b>
		10', CAT5 10FT	CAT5 10FT J1
		15, CAT5 15FT	CAT5 15FT J1



**Capable Luminaire**

This item is an A+ capable luminaire, which has been designed and tested to provide consistent color appearance and out-of-the-box control compatibility with simple commissioning.

- All configurations of this luminaire meet the Acuity Brand's specification for chromatic consistency.
- This luminaire is part of an A+ Certified solution for nLight control networks when ordered with drivers marked by a Shaded background\*
- This Luminaire is part of an A+ Certified solution for nLight control networks, providing advanced control functionality at the luminaire level, when selection includes driver and control options marked by a shaded background\*

To learn more about A+, visit [www.acuitybrands.com/aplus](http://www.acuitybrands.com/aplus).

\*See ordering tree for details

**nLight® AIR Control Accessories:**

Order as separate catalog number. Visit [www.acuitybrands.com/products/controls/nlightair](http://www.acuitybrands.com/products/controls/nlightair).

Wall switches	Model number
On/Off single pole	rPODB [color]
On/Off two pole	rPODB 2P [color]
On/Off & raise/lower single pole	rPODB DX [color]
On/Off & raise/lower two pole	rPODB 2P DX [color]
On/Off & raise/lower single pole	rPODBZ DX WH <sup>1</sup>

**Notes**

1 Can only be ordered with the RES7Z zone control sensor version.

**nLight AIR**

nLight AIR is the ideal solution for retrofit or new construction spaces where adding communication is cost prohibitive. The integrated nLight AIR rPP20 Power Pack is part of each Indy L-Series Luminaire. These individually addressable controls offer the ultimate in flexibility during initial setup and for space repurposing.

**Simple as 1,2,3**

1. Install the nLight® AIR fixtures with embedded smart sensor
2. Install the wireless battery-powered wall switch
3. With CLAIRITY app, pair the fixtures with the wall switch and if desired, customize the sensor settings for the desired outcome



nLight AIR rPODB 2P DX

Mobile Device