

Gotham Architectural Downlighting
LED Downlights

4" EVO® Square nTune™
Lensed Wallwash
Tunable White
Warm Dimming



Solid-State Dynamic Lighting

FEATURES

INTENDED USE

An economical Tunable White solution that reproduces natural light patterns and colors, complements materials, and supports productivity.

OPTICAL SYSTEM

- Self-flanged or flangeless semi-specular, matte-diffuse or specular finishing trim
- Patented Bounding Ray™ Optical Principle design (U.S. Patent No. 5,800,050) provides 45° cut-off to source and source image for a smooth and continuous transition from lensed source to the top of the reflector down to the bottom of the reflector.
- Top-down flash characteristic
- Polycarbonate lens integral to light engine

MECHANICAL SYSTEM

- 16-gauge galvanized steel construction; maximum 1-1/2" ceiling thickness
- Telescopic mounting bars maximum of 32" and minimum of 15", preinstalled, 4" vertical adjustment
- Toolless adjustments post installation
- Junction box capacity: 8 (4 in, 4 out) 12AWG rated for 90°C
- Light engine and driver accessible through aperture

ELECTRICAL SYSTEM

- Fully serviceable lensed LED light engine
- Rated 65,000 hours (L80) at 25°C ambient temperature
- Tested according to LM-79 and LM-80 standards
- Overload and short circuit protected
- Dim to Dark 100% - 0.1%

LISTINGS

- Fixtures are CSA certified to meet US and Canadian standards; wet location, covered ceiling

WARRANTY

5-year limited warranty. Complete warranty terms located at:
www.acuitybrands.com/CustomerResources/Terms_and_conditions.aspx

Note:

Actual performance may differ as a result of end user environment and application. All values are design or typical values, measured under laboratory conditions at 25 °C.

EXAMPLE: EVO4SQLW TUWH PROR/10 AR LSS MVOLT NLT

Series	Dynamic Feature	Dynamic Range ¹	Nominal lumens values ²	Reflector/Flange Color	Trim Style
EVO4SQLW 4" Square Lensed Wallwash	TUWH Tunable White WDIM Warm Dimming	PROR Productivity Range (3000K-5000K)	/07 750 lumens /10 1000 lumens	AR Clear PR Pewter WTR Wheat GR Gold	WR³ White painted BR³ Black painted WRAMF³ White painted antimicrobial finish
		RHYR Rhythm Range (2700K-6500K)	/15 1500 lumens /20 2000 lumens		
		HALR Halogen Range (3000K-1800K)	/25 2500 lumens /30 3000 lumens		
					(blank) Self-flanged FL Flangeless

Aperture Finish	Voltage	Control Interface Type	Options
LSS Semi-specular LD Matte-diffuse LS Specular	MVOLT 120 120V 277 277V 347 347V	NLT⁴ nLight nTune interface NLTER⁴ nLight nTune interface with emergency circuit ZT 0-10V dimming EDAB eldoLED DALI. Logarithmic dimming to <1%.	SF Single fuse TRW^{5,6} White painted flange TRBL^{6,7} Black painted flange 90CRI High CRI (90+) E10WCP Emergency battery pack, 10W Constant Power, CA Title 20 compliant with integral test switch E10WCPR Emergency battery pack, 10W Constant Power, CA Title 20 compliant with remote test switch CP⁸ Chicago Plenum BGTD Bodine Generator Transfer Device

ORDERING INFORMATION

ACCESSORIES order as separate catalog numbers (shipped separately)

CTA4-8 YK	Ceiling thickness adapter (extends mounting frame to accommodate ceiling thickness up to 5"). Adds 1" to fixture height.
FCS 7TSN XXX	Fresco Lighting Control with DMX and ethernet; XXX = Color. Refer to FRESCO spec sheet for additional options.
nPODM 2P DX CCT XX	nLight 2 Channels, On/off + raise/lower control, CCT, XX = Color. Refer to nLight .
nPODM 4S DX XX	nLight 4 Scene Control, On/off + raise/lower control, XX = Color. Refer to nLight .
nPODM 4S XX	nLight 4 Scene Control, XX = Color. Refer to nLight .

ACCESSORIES

DIMENSIONAL DATA

All dimensions are inches (centimeters) unless otherwise noted.

STANDARD DIMENSIONS

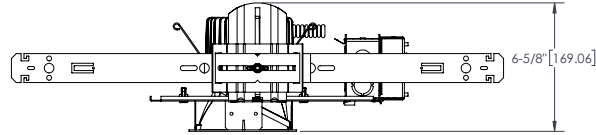
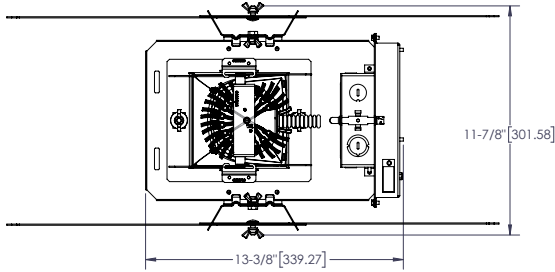

Aperture: 4-1/2 (11.4)
Ceiling Opening: 5-1/8" (13)
Overlap trim: 5-1/2" (14)

BATTERYPACK DIMENSIONS

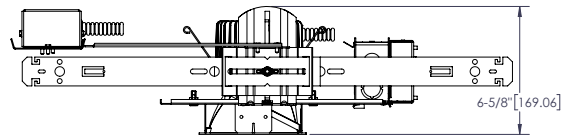
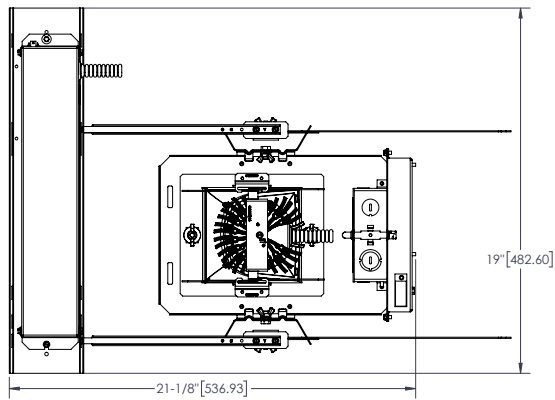

DYNAMIC SPECIFICATIONS

NOTES

ORDERING NOTES

- | | |
|---|---|
| 1. PROR and RHYR available only with TUWH. HALR available only with WDIM. | 5. Not available with white reflector. |
| 2. Nominal lumen values when tested at 3500K. | 6. Not available with FL. |
| 3. Not available with aperture finishes. | 7. Not available with black reflector. |
| 4. Requires power from nLight network bridge or nPS 80. | 8. Voltage-specific (120 or 277V). Not available with battery pack options. |

Distribution Curve Distribution Data Output Data Coefficient of Utilization

EVO4SQLW TUWH RHYP /30 4AR LSS CRI80 2700K INPUT WATTS: 29.4, DELIVERED LUMENS: 2477, LM/W=105.9 , WALLWASH, TEST NO. 19-102-B05P61

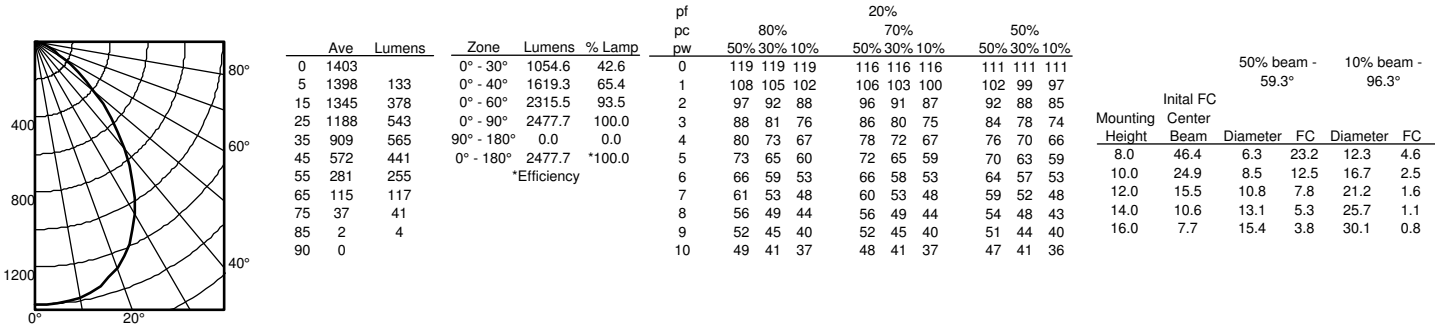

EVO4SQLW TUWH RHYP /30 4AR LSS CRI80 3500K INPUT WATTS: 29.4, DELIVERED LUMENS: 2298, LM/W=78.2 , WALLWASH, TEST NO. 19-102-B05P63

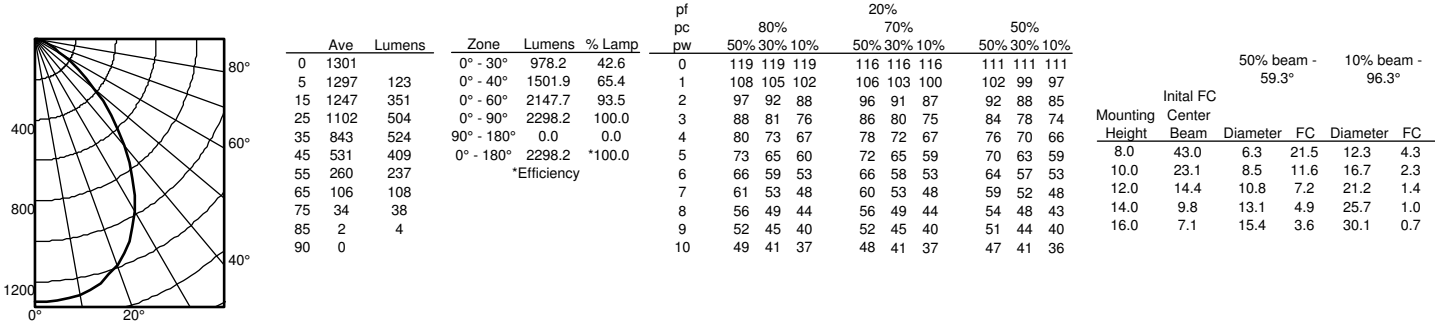

EVO4SQLW TUWH RHYP /30 4AR LSS CRI80 6500K INPUT WATTS: 29.4, DELIVERED LUMENS: 2560, LM/W=87.1 , WALLWASH, TEST NO. 19-102-B05P66

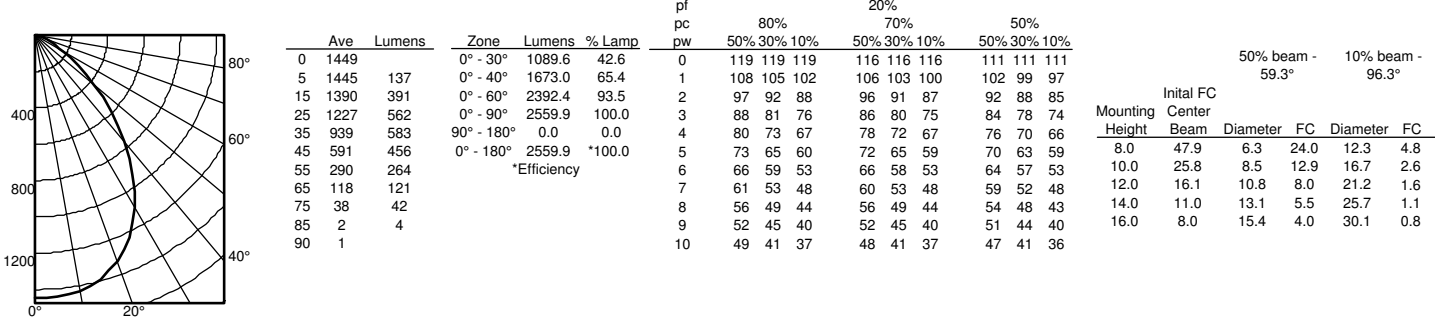

LUMEN OUTPUT MULTIPLIER - TRIM FINISH

FINISH	CLEAR (AR)	PEWTER (PR)	WHEAT (WTR)	GOLD (GR)	WHITE (WR/WRAMF)	BLACK (BR)
Specular (LS)	1.00	0.88	0.83	0.95	N/A	N/A
Semi-specular (LSS)	0.95	0.84	0.79	0.90	N/A	N/A
Matte-diffuse (LD)	0.85	0.73	0.69	0.80	N/A	N/A
Paint	N/A	N/A	N/A	N/A	0.87	0.73

PHOTOMETRY NOTES

- Tested in accordance with IESNA LM-79-08.
- Tested to current IES and NEMA standards under stabilized laboratory conditions.
- Typical CRI of 90 at 3000K.

MAINSTREAM DYNAMIC TUNABLE WHITE WITH NTUNE TECHNOLOGY

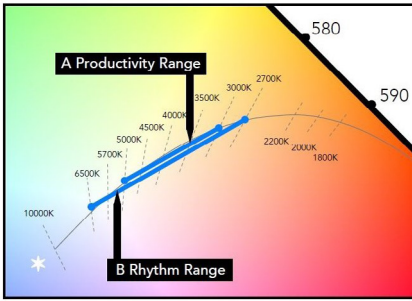

- A** Productivity Range 3000K to 5000K
- B** Rhythm Range 2700K to 6500K

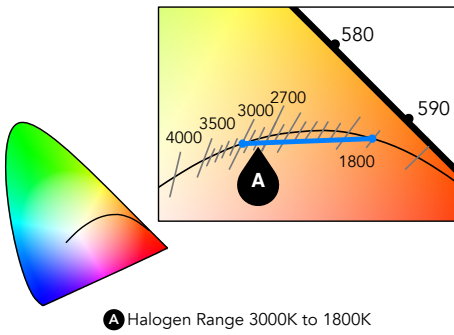

- A** Halogen Range 3000K to 1800K

Tunable white nTune™ is an all digital light color temperature control within an nLight enabled luminaire. This brings tunable white lighting control into the mainstream with repeatable, consistent results in an economical luminaire form and system already familiar to schools. Designers and facility operators are granted the freedom to tie scenes to specific activities or to complement colors or materials within a visual environment. nTune™ allows color temperature settings through the Productivity Range of 3000K to 5000K or Rhythm Range of 2700K to 6500K. Refer to nLight Programming User's Guide for instructions on customizing to your application with SensorView™.

TUNABLE WHITE GPHD

Gamut: One dimensional warm-Cool
Path: Direct 3000K to 5000K (Productivity Range) or 2700K to 6500K (Rhythm Range)
Handle: Two Natural Language Handles: Intensity and CCT
Data: nLight with nTune technology for both handles of control

TYPICAL NLIGHT NETWORK LAYOUT

