

ACULUX®



lini™

Specification Linear  
Downlighting









# Aculux lini™

Aculux precision luminaires have a well-deserved reputation for quality and innovation in the world of architectural downlighting.

The newest member of the Aculux family, Lini™ is a series of miniature linear downlights comprised of 1 inch square apertures. Boasting exceptional cutoff and glare control, Aculux lini blends seamlessly and discreetly into any architecture.

Lini is also the industry's only comprehensive miniature linear downlight, adjustable accent, and wall wash family offering truly coordinated apertures.

Aculux lini recessed luminaires provide sophisticated, modern minimalism to any residential, hospitality, or corporate environment.



1 inch

Introducing

# Aculux lini™

## Power & Performance ... miniature form factor

Although diminutive in size, Aculux lini delivers exceptional power and performance. Available in five discrete lengths, lini delivers 370 to 2230 lumens per downlight. With these levels of illumination, Aculux lini is an excellent solution to add sophistication to any interior.



370 Lumens



740 Lumens



1115 Lumens



1480 Lumens



2230 Lumens

*Images are to scale*





## Precision Crafted Optics

Aculux provides precision beam control in five distributions for general illumination, accent lighting, or wall washing. The ultra low glare optics, coupled with shielding baffle, provides industry leading brightness and glare control to make the light source virtually disappear.



### Precision Beam Control

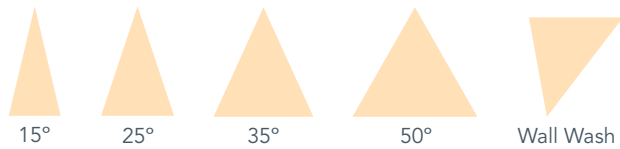

### Ultra Low Glare Optics & Superior Shielding

Provide 40° visual cutoff to source and source image

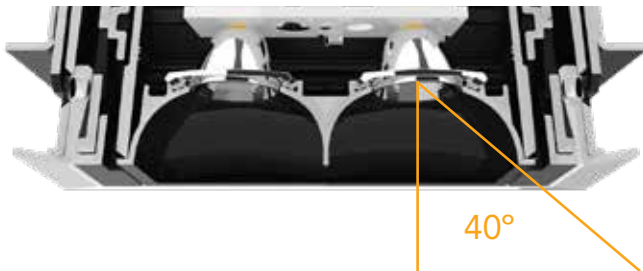

### Exceptional Quality of Light

Binned to within 2 step MacAdam Ellipse

< 2 SDCM









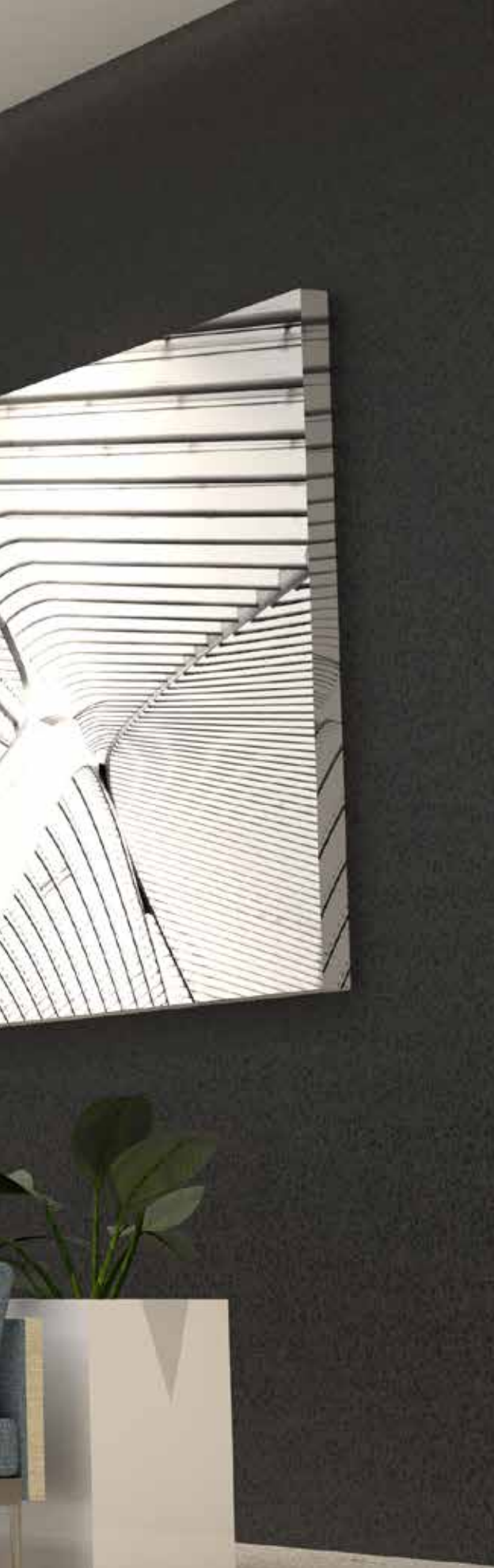

## Coordinated Apertures

Aculux lini is the only complete family of miniature linear recessed luminaires offering truly coordinated apertures. From the room side, the downlight, adjustable accent and wall wash all look virtually identical allowing you to provide all layers of light from a single linear downlight family. Lini adjustable accent luminaire is also bi-directional with  $\pm 35^\circ$  tilt, providing the capability to accent vertical surfaces quietly and discreetly.

### Downlight



### Adjustable



### Wall Wash



## Meticulous Design Meets Beautiful Style

Aculux lini is capable of delivering the sophisticated look of flangeless for virtually any ceiling material....drywall, millwork, stone, tile, or metal. Lini is also available in five finishes to coordinate with most interiors. And the optics were designed to keep light off the baffle, meaning all five finishes provide a decorative element while having virtually no luminance, allowing the light source to disappear.

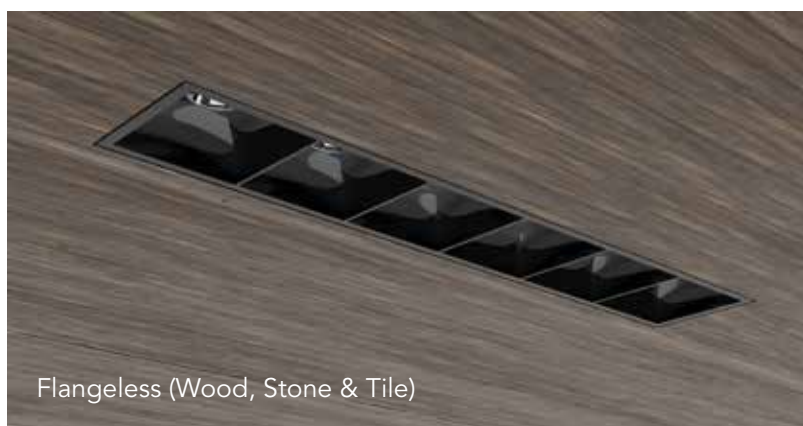

Flangeless (Wood, Stone & Tile)

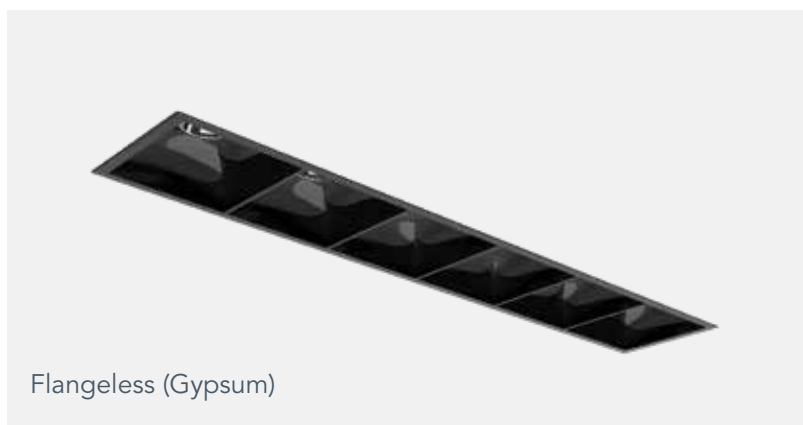

Flangeless (Gypsum)

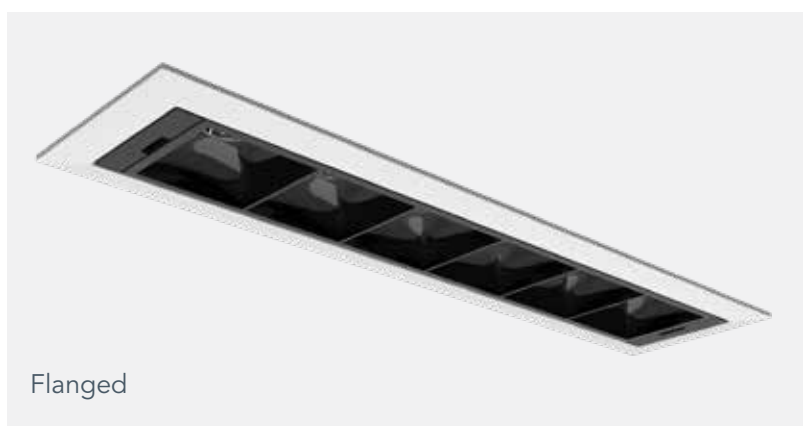

Flanged



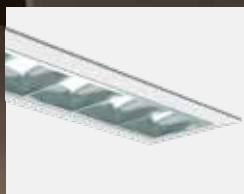
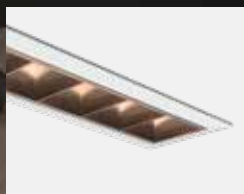
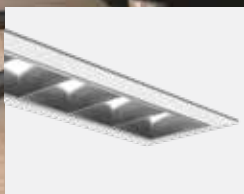







## Small Housing Profile

Aculux lini is a perfect solution where plenum space is restricted. The recessed new construction housing stands at just 4" above the ceiling and is IC, Air-Tight, and CCEA (Chicago Plenum) approved standard. All lengths (2, 4, 6, 8, 12 cell) feature integral driver compatible with most 0-10V and forward/reverse phase controls for simplified installation and maintenance.

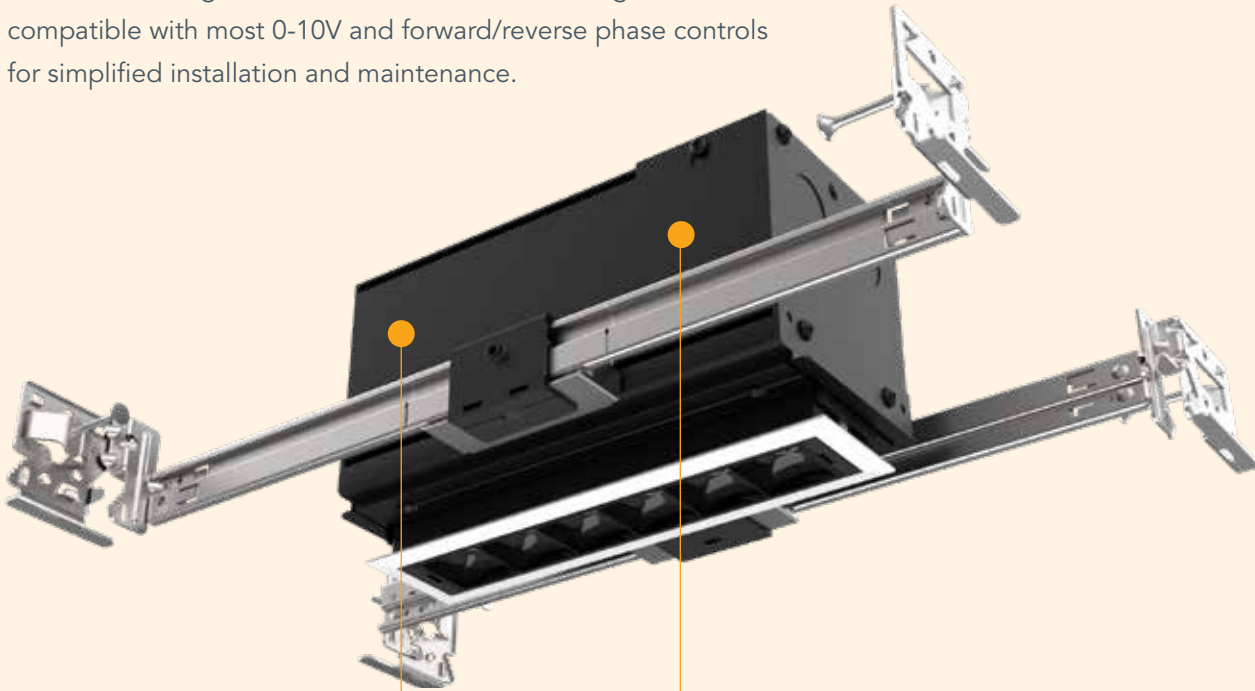

### Integral Driver

Compatible with Forward Phase Triac Dimmers & 0-10V Dimmers  
Down to 1%

### Low Profile Housing

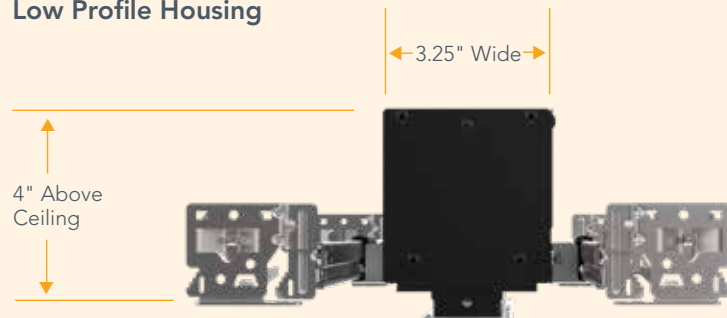

IC, Air-Tight, Chicago Plenum (CCEA) Standard



# Configurations

## Beam Spreads

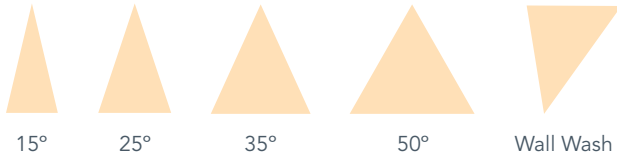

## Color Temperatures

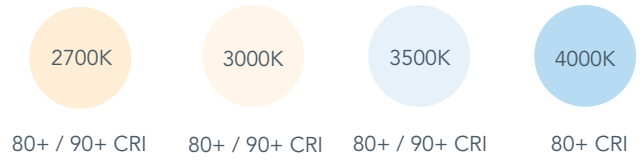

## Style

2 Cell / 370 Lumens



4 Cell / 740 Lumens



6 Cell / 1115 Lumens



8 Cell / 1480 Lumens



12 Cell / 2230 Lumens



## Function



## Finishes

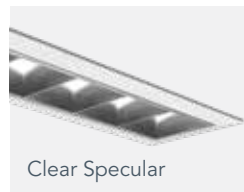

## Flange Styles

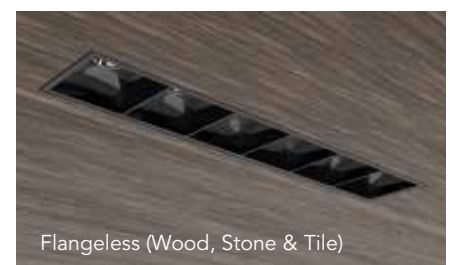

3-Inch



2-Inch



4-Inch



## Aculux® is Precision Defined

Aculux precision luminaires have been setting the benchmark in architectural downlighting for decades. They are among the most powerful luminaires in their class, delivering an industry leading 31,000 CBCP and 3000 lumens from a 3-inch aperture. With patented precision aiming and adjustment features, light can be directed precisely as desired. And the patented Tru-Line™ installation platform ensures perfect fixture-to-fixture alignment, giving the specifier the confidence that the integrity of their design will be maintained. When it comes to precision optics, aiming and installation, Aculux luminaires are spot-on in every way.

